

DECISION OF THE BOARD OF APPEAL OF THE EUROPEAN
UNION AGENCY FOR THE COOPERATION OF ENERGY
REGULATORS

28 May 2021

*(Application for annulment – ACER Decision No. 30/2020 – cost sharing of redispatching
and countertrading in Core CCR – ACER’s competence - principle of proportionality –
principle of non-discrimination – duty to reason – language of ACER decisions – principle of
good administration)*

Case number A-001-2021 (consolidated)

Language of the case English

Appellants

Polskie Sieci Elektroenergetyczne S.A. (“PSE” or “Appellant I”)
Represented by: Leszek Jesień

Commission de Régulation de l’Énergie (“CRE” or “Appellant II”)
Represented by: Jean-François Carenco

TransnetBW GmbH (“TransnetBW” or “Appellant III”)
Represented by: Thomas Burmeister and Petra Kistner, of White &
Case LLP

Bundesnetzagentur (“BNetzA” or “Appellant IV”)
Represented by: Jochen Homann

TenneT TSO GmbH/Tennet TSO B.V. (“TenneT” or “Appellant
V”)
Represented by: Dirk Uwer, Jörg Meinzenbach and Paul David
Rieger, of Hengeler Mueller Partnerschaft von Rechtsanwälten mbH

Réseau de Transport d’Électricité (“RTE” or “Appellant VI”)
Represented by: Matthew Levitt, of Baker Botts (Belgium) LLP

Defendant European Union Agency for the Cooperation of Energy Regulators
 (“ACER” or “the Agency”)
Represented by: Christian Zinglensen

Interveners

Amprion GmbH (“Amprion” or “Intervener I”)
Represented by : Daniel Rauhut and Maximilian Falbrede
On behalf of Appellant III.

Hungarian Energy and Public Utility Regulatory Authority
 (“HEA” or “Intervener II”)
Represented by : Pál Ságvári
On behalf of the Defendant.

Commission for Electricity and Gas Regulation (“CREG” or “Intervener III”)

Represented by : Koen Loquet

On behalf of the Defendant.

Energy Regulatory Office (“ERO” or “Intervener IV”)

Represented by : Jana Haasová

On behalf of the Defendant.

MAVIR Hungarian Independent Transmission Operator Company Ltd (“Mavir” or “Intervener V”)

Represented by : Gergő Holló

On behalf of the Defendant.

Regulatory Office for Network Industries (“URSO” or “Intervener VI”)

Represented by : Andrej Juris

On behalf of the Defendant.

Application for

Annulment and remittal of Decision No. 30/2020 of 30 November 2020 on the Core CCR TSOs’ Proposal for the methodology for cost sharing of redispatching and countertrading adopted by the European Union Agency for the Cooperation of Energy Regulators (“**the Contested Decision**”).

THE BOARD OF APPEAL

composed of Andris Piebalgs (Chairman), Yvonne Fredriksson (Rapporteur), Mariano Bacigalupo Saggese, Walter Boltz, Michael Thomadakis and Marius Swora (Members).

Acting Registrar: Ronja Linßen

gives the following

DECISION

I. Legal background

1. Article 74 of Commission Regulation (EU) 2015/1222 of 24 July 2015 establishing a guideline on capacity allocation and congestion management (“CACM”) entitled “*Redispatching and countertrading cost sharing methodology*”, requires Transmission Systems Operators (“TSOs”) of each Capacity Calculation Region (“CCR”) to submit a proposal for a common methodology for redispatching and countertrading cost sharing (“RDCTCS”) for their region, no later than 16 months after the decision on capacity calculation regions (“CCM”) is taken, and lays down the regulatory requirements in relation to the adoption of the RDCTCS.
2. The bottom-up decision-making procedure for the adoption of the RDCTCS is set out in Article 9 CACM, entitled “*Adoption of terms and conditions or methodologies*”.

3. The Contested Decision - addressed to 17 TSOs of the Core CCR - adopts the RDCTCS for the Core CCR and joins it as Annex I to the Contested Decision.

II. Facts giving rise to the dispute

4. Pursuant to Article 9(1), 9(7)(h) and 74(1) CACM, TSOs of each CCR are required to develop a common proposal for ROSC in accordance with Article 74 CACM and submit it to the competent NRAs.
5. All Core TSOs did not submit their RDCTCS proposal for the Core CCR by 17 May 2018.
6. In accordance with Article 9(4) CACM, All Core TSOs informed Core NRAs and ACER about the failure to submit such a proposal. The reported reason for the failure was that Core TSOs needed more time to test and develop several aspects of the RDCTCS. In accordance with 9(4) CACM, ACER, in turn, informed the European Commission about All Core TSOs' failure to submit their RDCTCS Proposal.
7. The European Commission consulted with Core TSOs, NRAs and ACER and provided guidance to Core TSOs to develop a proposal and submit it for approval as early as possible, assuming that further testing and development could be performed during the approval proceedings of Core NRAs and that NRAs could, in any event, request necessary amendments to All Core TSOs' proposal.
8. All Core TSOs developed the RDCTCS Proposal for Core CCR ("**All Core TSOs' RDCTCS Proposal**"). The submission of All Core TSOs' RDCTCS Proposal was received by the last Core NRAs on 27 March 2019. All Core TSOs' RDCTCS Proposal was accompanied with a supporting Explanatory Document ("**All Core TSOs' RDCTCS Explanatory Document**")¹.
9. Core TSOs did not publicly consult on their RDCTCS Proposal prior to its submission.
10. Upon Core NRAs' request, ACER extended the period for Core NRAs to grant regulatory approval to All Core TSOs' RDCTCS Proposal by 6 months, i.e. until 27 March 2020 (ACER Decision 11/2019²).
11. On 13 March 2020, All Core TSOs published All Core TSOs' RDCTCS Experimentation Report³.
12. On 27 March 2020, the Chair of the Core Energy Regulators' Forum informed ACER on behalf of All Core NRAs that Core NRAs had not been able to reach an agreement on All Core TSOs' Proposal by 27 March 2020. In accordance with Article 9(11) CACM and Article 5(3) of Regulation (EU) 2019/942 ("**ACER Regulation**"), All Core NRAs referred All Core TSOs' RDCTCS Proposal to ACER for regulatory approval in accordance with Article 6(10)(a) ACER Regulation.
13. On 27 March 2020, All Core NRAs published All Core NRAs' RDCTCS Non-Paper⁴.
14. On 30 April 2020, All Core TSOs published All Core TSOs' RDCTCS Non-Paper⁵.
15. As of 9 April 2020, ACER closely cooperated with All Core NRAs and Core TSOs and further consulted on the amendments to All Core TSOs' RDCTCS Proposal during numerous teleconferences and meetings and through exchanges of amendments. In this period, discussions were held within ACER's Electricity Working Group ("**AEWG**").
16. From 31 July 2020 until 20 August 2020, ACER held a hearing phase, as described in ACER's Rules of Procedure, with All Core NRAs and All Core TSOs.
17. On 18 November 2020, the Board of Regulators ("**BoR**") gave its favourable opinion to the Agency's draft Contested Decision.

¹ https://www.e-control.at/documents/1785851/0/201902_Core+CACM+74_Explanatory+note.pdf/083b4ff9-7617-588b-987b-51d55944a097?t=1575301393324

² https://acer.europa.eu/Official_documents/Acts_of_the_Agency/Individual%20decisions/ACER%20Decision%2011-2019%20on%20CORE%20RDCT.pdf

³ Annex 23 to the Defence, p. 15.

⁴ Annex A.3.2 to Appeal VI.

⁵ Annex 79 to the Defence, p. 12.

18. ACER issued the Contested Decision on 30 November 2020. Annex I to the Contested Decision contains the RDCTCS.

III. Procedure.

19. On 29 January 2021, Appellant I, Appellant II, Appellant III, Appellant IV and Appellant V submitted appeals to the Registry of the Board of Appeal against the Contested Decision, respectively in cases A-001-2021, A-002-2021, A-003-2021, A-004-2021 and A-005-2021.
20. On 30 January 2021, Appellant VI submitted an appeal to the Registry of the Board of Appeal against the Contested Decision in case A-006-2021.
21. On 1 February 2021, the above-mentioned appeals were received by the Registry of the Board of Appeal. The Registry of the Board of Appeal duly acknowledged receipt through a notice.
22. On 16 February 2021, the announcements of the appeals were published on the website of the Agency.
23. On 18 February 2021, case A-003-2021, which relates to three different ACER Decisions, was divided into three cases for procedural reasons, namely (i) case A-009-2021 regarding the appeal against the Contested Decision; (ii) case A-010-2021 regarding the appeal against ACER Decision No 33/2020 and (iii) case A-011-2021 regarding the appeal against ACER Decision 35/2020.
24. On 18 February 2021, in accordance with Article 20(3)(h) of the Rules of Procedure, the Chairperson of the Board of Appeal consolidated appeal cases A-001-2021, A-002-2021, A-004-2021, A-005-2021, A-006-2021 and A-009-2021, involving similar issues and being related to the same Contested Decision 30/2020, into A-001-2021 (consolidated).
25. On 19 February 2021, the Registrar communicated the composition of the Board of Appeal to the Parties.
26. On 23 February 2021, the Registry of the Board of Appeal received Intervener I's application for leave to intervene on behalf of Appellant III.
27. On 1 March 2021, the Registry of the Board of Appeal received an application for leave to intervene on behalf of Appellants II and VI by Union française d'Électricité ("UFE").
28. On 2 March 2021, the Registry of the Board of Appeal received applications for leave to intervene on behalf of the Defendant by Interveners II, III, IV, V and VI and by the Netherlands Authority for Consumers and Markets ("ACM").
29. On 5 March 2021, the Board of Appeal invited the Appellants to update the confidentiality status of their Appeal by 10 March 2021 in the light of the consolidation of the cases and access of other Appellants to the documents. To this extent, on 10 March 2021, Appellant V submitted an updated confidentiality request regarding its Annex 9 to the Appeal.
30. On 12 March 2021, the Board of Appeal allowed Appellant V to regularise its appeal beyond the set deadline, having received no objections to do so by the Defendant.
31. On 12 March 2021, the Registry informed the Appellants and the Defendant about the received applications for leave to intervene along with an invitation to lodge observations to the application and the opportunity to update the confidentiality status of their Appeal documents in light of the applications for leave to intervene by 19 March 2021.
32. On 18 March 2021, ACER filed its Defence with the Registry requesting the BoA to dismiss all appeals.
33. On 19 March 2021, Appellant V lodged an observation objecting to the intervention of UFE because its application for leave to intervene failed to meet the requirements of Article 11(1) and (4) of the Rules of Procedure. Furthermore Appellant V submitted an updated confidentiality request regarding the application for intervention by UFE.
29. On 19 March 2021, Appellant VI lodged observations objecting to the intervention of ACM because its application for leave to intervene failed to meet the requirements of Article 11(4) of the Rules of Procedure.

30. On 19 March 2021, Appellant III lodged observations on the merits of the applications to intervene submitted by UFE, ACM and Interveners I, II, III, IV, V and VI.
31. On 23 March 2021, the Board of Appeal granted Intervener I the right to intervene on behalf of Appellant III.
32. On 23 March 2021, the Board of Appeal dismissed UFE's application for leave to intervene on behalf of Appellants II and VI.
33. On 23 March 2021, the Board of Appeal granted Interveners III, IV, V and VI the right to intervene on behalf of the Defendant.
34. On 23 March 2021, the Board of Appeal dismissed ACM's application for leave to intervene on behalf of the Defendant.
35. On 23 March 2021, the Board of Appeal invited all Appellants to submit their Replies to the Defence, including further observations on the merits of interventions of Interveners I, II, III, IV, V and VI, with a maximum of 15 pages, within the extended period of time of 8 April 2021.
36. On 23 March 2021, the Board of Appeal granted all Interveners access to the case documents and invited them to submit a second submission according to Article 11(9) of the Rules of Procedure. No second submissions were submitted by the Interveners.
37. On 24 March 2021, the Defendant submitted a regularised Defence within the set deadline upon request of the Registry.
38. On 25 March 2021, the Board of Appeal extended the deadline for the Replies until 13 April 2021.
39. On 29 March 2021, the Board of Appeal allowed the Defendant to regularise its Defence beyond the set deadline, having received no objections to do so by the Appellants.
40. On 1 April 2021 a further extension for the Replies was granted until 14 April 2021.
41. On 14 April 2021, all Appellants filed their Replies to the Defence with the Registry.
42. On 15 April 2021, the Board of Appeal invited the Defendant to submit its Rejoinder, with a maximum of 15 pages, within the extended period of time of 7 May 2021.
43. On 15 April 2021, the Defendant submitted a request for extension of the maximum length of the Rejoinder, which was denied by the Board of Appeal on 19 April 2021.
44. On 16 April 2021, the Board of Appeal requested the Defendant to disclose (i) a cover note and letter presented to the BoR in connection with the meeting of 13 December 2017 and (ii) legal advice presented by the Legal Expert Network ("LEN") in connection with the meeting of 14 March 2018.
45. On 20 April 2021, the Defendant disclosed the documents in response to the Board of Appeal's Disclosure Request.
46. On 28 April 2021, the Board of Appeal sent a First Request for Information to all parties in accordance with Article 20 of its Rules of Procedure.
47. On 3 May 2021, Appellant III and VI submitted observations to the documents disclosed by the Defendant, among other Appellant VI requested full access to the confidential documents.
48. On 3 May 2021, the Board of Appeal sent a Second Request for Information to the Defendant and Appellant V in accordance with Article 20 of its Rules of Procedure.
49. On 5 May 2021, the Board of Appeal issued its Decision on the Confidentiality of the Disclosed Documents.
50. On 5 May 2021, all parties submitted their replies to the First Request for Information and Appellant V submitted its reply to the Second Request for Information.
51. On 7 May 2021 the Defendant submitted its Rejoinder to the Registry.
52. On 10 May 2021, the Defendant submitted its reply to the Second Request for Information.
53. The Board of Appeal held an oral hearing on 17 May 2021.
54. On 19 May 2021, the Board of Appeal sent a Third Request for Information to all parties in accordance with Article 20 of its Rules of Procedure.

55. On 21 May 2021, all parties submitted their replies to the Third Request for Information, except Appellant II, who failed to reply within the set deadline.

IV. Main arguments of the Parties

56. The claims of each of the Appellants are duly summarised in each of the Consolidated Pleas, listed below:

- First Consolidated Plea - Excessive scope of the RDCTCS and unlawful determination of XNEs.*
- Second Consolidated Plea – Unlawful inclusion of NEs covered by Action Plans in the RDCTCS scope.*
- Third Consolidated Plea: – Decomposition of flows.*
- Fourth Consolidated Plea – Overestimation of loop flows and internal flows from importing zones.*
- Fifth Consolidated Plea – Netting of flow components.*
- Sixth Consolidated Plea – Priority of loop flows above the threshold.*
- Seventh Consolidated Plea – Threshold for acceptable loop flows.*
- Eighth Consolidated Plea – Polluter Pays Principle.*
- Ninth Consolidated Plea – Lack of timescale to implement the RDCTC.*
- Tenth Consolidated Plea – Definition of new implementation timeline.*
- Eleventh Consolidated Plea – Principle of proportionality.*
- Twelfth Consolidated Plea – Principle of non-discrimination.*
- Thirteenth Consolidated Plea – Lack of Impact Study.*
- Fourteenth Consolidated Plea – ACER exceeded its competence and infringed the principle of conferral.*
- Fifteenth Consolidated Plea – ACER exercised NRAs’ competences.*
- Sixteenth Consolidated Plea – Language plea.*
- Seventeenth Consolidated Plea – Duty to duly reason.*
- Eighteenth Consolidated Plea – Duty of good administration.*
- Nineteenth Consolidated Plea – Review of RDCTCS.*

57. The Appellants request the Board to rule on the remedies sought in Section VI.I below, Remedies Sought.

58. The Defendant requests the Board of Appeal (i) to dismiss the appeal of Appellant I because it is inadmissible and (ii) to dismiss the appeals of Appellants I to VI in their entirety because they are unfounded.

V. Admissibility

V.I Ratione temporis

59. Article 28(2) ACER Regulation reads as follows: “*The appeal shall include a statement of the grounds for appeal and shall be filed in writing at ACER within two months of the notification of the decision to the person concerned, or, in the absence thereof, within two months of the date on which ACER published its decision*”.
60. ACER adopted the Contested Decision on 30 November 2020 and published the Contested Decision on its website on 3 December 2020.
61. On 29 January 2021, Appellant I, Appellant II, Appellant III, Appellant IV and Appellant V submitted appeals to the Registry of the Board of Appeal against the Contested Decision, respectively in cases A-001-2021, A-002-2021, A-003-2021, A-004-2021 and A-005-2021.
62. On 30 January 2021, Appellant VI submitted an appeal to the Registry of the Board of Appeal against the Contested Decision in case A-006-2021.
63. Therefore, the appeals of Appellant I, Appellant II, Appellant III, Appellant IV, Appellant V and Appellant VI are admissible *ratione temporis*.

V.II Ratione personae

64. Article 28(1) of Regulation (EU) 2019/942 provides that “[a]ny natural or legal person, including the regulatory authorities, may appeal against a decision referred to in point (d) of Article 2 which is addressed to that person, or against a decision which, although in the form of a decision addressed to another person, is of direct and individual concern to that person.”
65. Article 2 of the Contested Decision stipulates that it is addressed to:
1. 50Hertz Transmission GmbH,
 2. Amprion GmbH,

3. Austrian Power Grid AG,
 4. C.N.T.E.E. Transelectrica S.A.,
 5. ČEPS a.s.,
 6. Creos Luxembourg S.A.,
 7. ELES, d.o.o.,
 8. Elia System Operator NV/SA⁶,
 9. HOPS d.o.o., Hrvatski operator prijenosnog sustava,
 10. MAVIR ZRt,
 11. Polskie Sieci Elektroenergetyczne,
 12. Réseau de Transport d'Electricité,
 13. Slovenská elektrizačná prenosová sústava, a.s.,
 14. TenneT TSO B.V.,
 15. TenneT TSO GmbH,
 16. TransnetBW GmbH, and
 17. VÜEN-Vorarlberger Übertragungsnetz GmbH.
66. The addressees of the Contested Decision are the TSOs of the Core CCR.
 67. Appellant I, Appellant III, Appellant V and Appellant VI are Core TSOs listed as addressees of the Contested Decision.
 68. Appellant II and Appellant IV are not addressees of the Contested Decision. However, they are Core NRAs and have, therefore, a direct and individual interest in the outcome of the present case. Appellant II, the French NRA, participated in the decision-making process leading up to the Contested Decision, is part of ACER's BoR and has supervisory power over the French TSO, which is an addressee of the Contested Decision. Appellant IV, the German NRA, participated in the decision-making process leading up to the Contested Decision, is part of ACER's BoR and has supervisory power over the German TSOs, which are addressees of the Contested Decision.
 69. Therefore, the appeals of Appellant I, Appellant II, Appellant III, Appellant IV, Appellant V and Appellant VI are admissible *ratione personae*.

V.III Ratione materiae

70. Article 28(1) ACER Regulation reads as follows: “Any natural or legal person, including the regulatory authorities, may appeal against a decision referred to in point (d) of Article 2 which is addressed to that person, or against a decision which, although in the form of a decision addressed to another person, is of direct and individual concern to that person.”
71. The Contested Decision is an individual decision of ACER in accordance with Article 2(d) ACER Regulation, which was issued on the basis of Articles 5(3) and 6(10) ACER Regulation, following a consultation with Core NRAs and Core TSOs.
72. ACER alleges in its Defence⁷ that the appeal of Appellant I is inadmissible because the remedy sought by Appellant I is not in accordance with Article 28(5) ACER Regulation.
73. ACER claims that the remedy sought by Appellant I requests the Board of Appeal to issue directions to ACER whereas the Board of Appeal can only confirm the Contested Decision or remit the case to the competent body of ACER in accordance with Article 28(5) ACER Regulation.
74. The remedy sought by Appellant I is as follows⁸:
“The Appellant respectfully requests the Board of Appeal to rule that the Appellant's appeal is well-founded, and to rule that, according to and following applicable procedures, the Contested Decision shall be replaced by a new one. The new decision should indicate the modification of CS Methodology as follows:

⁶ The Board of Appeal notes a clerical error, whereby the Belgian TSO, Elia System Operator NV/SA, is cited twice in Article 2 of the Contested Decision.

⁷ Defence, paras 158-161.

⁸ Appeal I, para 10.

- i. to amend Article 6(6) and Article 6(7) in accordance with the correct GSK/LSK approach to flow decomposition which is compliant with the definitions of flow components;
- ii. to add precise criteria for amendments to CC Methodologies;
- iii. to introduce a provision making the implementation of CS Methodology conditional upon earlier implementation of CC Methodologies amended according to the criteria defined in CS Methodology;
- iv. to lower the common threshold set in Article 7(3) of CS Methodology and to change recital (8) of the preamble to CS Methodology in line with this modification.

The case should be remitted to the competent body of ACER to modify the Contested Decision by amending the contested articles in accordance with Article 28(5) of Regulation 2019/942.”

75. In its Reply⁹, Appellant I states that it “had requested and still requests the Board of Appeal to remit the case to the competent body of ACER (..)” and that it “did not and still does not request the Board of Appeal to replace the Contested Decision with a new one.”
76. The Board of Appeal finds that, when stating “The Appellant respectfully requests the Board of Appeal to rule that the Appellant’s appeal is well-founded, and to rule that, according to and following applicable procedures, the Contested Decision shall be replaced by a new one. The new decision should indicate the modification of CS Methodology as follows: (..)”, the appeal of Appellant I requests the Board of Appeal to remit the case to the competent body of ACER in accordance with Article 28(5) ACER Regulation.
77. The Board of Appeal furthermore observes that Article 28(5) ACER Regulation stipulates that ACER “shall be bound by the decision of the Board of Appeal”.
78. In the light of the above, the Board of Appeal concludes that the appeal of Appellant I is admissible.
79. The Board of Appeal finds that the appeal of Appellant II is partially inadmissible.
80. More specifically, Sub-Plea 6.1.2, entitled “*Infringement of the right of defence*” of Plea 1, entitled “*First plea: Infringement of the duty to respect the provisions on the use of languages in the European Union*” (paragraphs 67 to 73 of the appeal of Appellant II) of the appeal of Appellant II is inadmissible.
- Given that Appellant II voluntarily decided to submit its appeal in English before the Board of Appeal, any debate or challenge about the submission of an appeal in a different language is hypothetical and inadmissible *ratione materiae*. The principle of non-admission of hypothetical appeals has been consistently sustained by the EU Courts’ case-law. An appellant’s interest in bringing proceedings must be vested and current¹⁰. It may not concern a future and hypothetical situation¹¹. The interest must, in the light of the purpose of the action, exist at the stage of lodging the action, failing which the action will be inadmissible, and continue until the final decision, failing which there will be no need to adjudicate¹². The interest in bringing proceedings is an essential and fundamental prerequisite for any legal proceedings¹³.
81. However, the remainder of Plea 1 of the appeal of Appellant II, entitled “*First plea: Infringement of the duty to respect the provisions on the use of languages in the European Union*”, namely Sub-Plea 6.1.1, entitled “*Infringement of the duty to issue decision in the addressees’ official language*” is admissible.

⁹ Appellant I’s Reply, para 5.

¹⁰ Cases C-519/07 P, Commission v Koninklijke FrieslandCampina, EU:C:2009:556, para 65 and C-564/13 P, Planet v Commission, EU:C:2015:124, para 34.

¹¹ Cases 204/85, Strogili v Court of Auditors, EU:C:1987:21, para 11; C-269/12 P, Cañas v Commission, EU:C:2013:415, paras 16 and 17 and Order T-167/01, Schmitz-Gotha Fahrzeugwerke v Commission, EU:T:2003:121, paras 47 and 58.

¹² Cases C-239/12 P, Abdulrahim v Council and Commission, EU:C:2013:331, para 61 and C-269/12 P, Cañas v Commission, EU:C:2013:415, para 15.

¹³ Order 206/89 R, S. v Commission, EU:C:1989:333, para 8; C-682/13 P, Andechser Molkerei Scheitz v Commission, EU:C:2015:356, para 27 and C-33/14 P, Mory and Others v Commission, EU:C:2015:609, para 58.

82. Therefore, the appeals of Appellant I, Appellant II, Appellant III, Appellant IV, Appellant V and Appellant VI are admissible *ratione materiae*, except for Sub-Plea 1.2 of the appeal of Appellant II, which is inadmissible.

VI. Merits

VI.I Remedies sought by the Appellants

83. The remedy sought by Appellant I is as follows¹⁴:

“The Appellant respectfully requests the Board of Appeal to rule that the Appellant's appeal is well-founded, and to rule that, according to and following applicable procedures, the Contested Decision shall be replaced by a new one. The new decision should indicate the modification of CS Methodology as follows:

- i. to amend Article 6(6) and Article 6(7) in accordance with the correct GSK/LSK approach to flow decomposition which is compliant with the definitions of flow components;*
- ii. to add precise criteria for amendments to CC Methodologies;*
- iii. to introduce a provision making the implementation of CS Methodology conditional upon earlier implementation of CC Methodologies amended according to the criteria defined in CS Methodology;*
- iv. to lower the common threshold set in Article 7(3) of CS Methodology and to change recital (8) of the preamble to CS Methodology in line with this modification.*

The case should be remitted to the competent body of ACER to modify the Contested Decision by amending the contested articles in accordance with Article 28(5) of Regulation 2019/942.”

84. The remedy sought by Appellant II is as follows¹⁵:

“For the reasons set out above the Appellant, pursuant to Article 28(1) of Regulation (EU)2019/942 of the European Parliament and of the Council of 5 June 2019 establishing a European Union Agency for the Cooperation of Energy Regulators (hereinafter: the "Regulation 2019/942" or the "ACER Regulation"), REQUESTS ACER'S Board of Appeal: to annul Decision n ° 30-2020 of ACER of 30 November 2020 on the Core TSOs' proposal for the methodology for cost sharing of redispatching and countertrading entirely; or, in the event that the Board of Appeal does not annul the decision entirely, to annul article 3 and 7 of Annex I of Decision n ° 30-2020 of ACER of 30 November 2020 on the Core TSOs' proposal for the methodology for cost sharing of redispatching and countertrading.”

85. The remedy sought by Appellant III is as follows¹⁶:

“We therefore request on behalf of the Appellant the Board of Appeal in accordance with Art. 28 para. 4 ACER Regulation to annul the contested decisions¹⁷ and refer them back to the competent body of the Agency for new decisions in compliance with the legal opinion of the Board of Appeal.”

86. The remedy sought by Appellant IV is as follows¹⁸:

“The appellant pursuant to Article 28(1) of Regulation (EU) 2019/942 of the European Parliament and of the Council of 5 June 2019 establishing a European Union Agency for the Cooperation of Energy Regulators (hereinafter ACER Regulation) REQUESTS the Board of Appeal

- to annul Decision No 30/2020 of ACER of 30 November 2020 on the Core CCR TSOs' proposal for the methodology for cost sharing of redispatching and countertrading in its entirety and to remit the case to the competent body of ACER in accordance with Article 28(5) of the ACER Regulation;

or, in the event that the Board of Appeal does not annul the decision in its entirety,

- to annul the following provisions of Decision No 30/2020 of ACER of 30 November 2020 on the Core CCR TSOs' proposal for the methodology for cost sharing of redispatching and countertrading:

a. Article 2(2)(j) and Article 3 of its Annex I,

b. Article 7 of its Annex I,

c. Article 12(2) of its Annex I,

d. All parts and clauses of Decision No 30/2020 of ACER and its Annex I, which make explicit reference to the provisions under a. to c.

and to remit the case to the competent body of ACER in accordance with Article 28(5) of the ACER Regulation.”

87. The remedy sought by Appellant V is as follows¹⁹:

¹⁴ Appeal I, para 10.

¹⁵ Appeal II, para 4.

¹⁶ Appeal IV, para 4.

¹⁷ As set out above in Section III, “Procedure”, the appeal of the Appellant III relates to 3 different ACER Decisions, including the Contested Decision.

¹⁸ Appeal III, p. 3.

¹⁹ Appeal V, para 218.

“On the above grounds and for the reasons set out above, TenneT respectfully requests the BoA to annul the Decision in its entirety, which, subsequently, shall be replaced by a new decision on the methodology for cost-sharing of redispatching and counter-trading costs.”

88. The remedy sought by Appellant VI is as follows²⁰:

“The Appellant requests the Board of Appeal: a. By reason of ACER’s infringement of Regulation No 1/1958, to annul the Decision (including its Annex I); b. In the alternative, by reason of ACER’s infringement of Regulation No 1/1958, to (i) declare the Decision (including its Annex I) unenforceable pending the provision by ACER of a French-language version of the Decision (including its Annex I), and (ii) extend the implementation timeline set in Article 13 of Annex I to the Decision by a period equal to the period that the Decision (including its Annex I) remains unenforceable; c. Unless the Decision (including its Annex I) is annulled pursuant to the request under point a. above, to annul Article 1 of the Decision and Articles 3, 7, 13 and Recitals 3, 4, 6, 7, 8, 9 and 10 of Annex I to the Decision; d. And to remit the Decision and its Annex I to the competent body of ACER in accordance with Article 28(5), ACER Regulation.”

V.II Pleas and arguments of the Parties.

First Consolidated Plea – Excessive scope of the RDCTCS and unlawful determination of XNEs.

1.1 The Board of Appeal’s appraisal of the RDCTCS scope.

1.1.1 ACER’s regulatory supervision when adopting the Contested Decision.

1.1.2 RAs in the zonal market model.

1.1.3 The need for coordination of RAs in Core CCR.

1.1.4 Operational security in EU electricity regulation.

1.1.5 EU electricity regulation links the RDCTCS, RDCT and ROSC methodologies.

1.1.6 All 3 methodologies have duly been linked.

1.1.7 The RDCTCS is in line with the CACM, the ER and the PPP.

1.1.8 The blending of the scope of RAs deriving from CROSA was decided upon by ACER Decision 07/2019 and not appealed.

1.1.9 The RDCTCS scope is necessary and proportionate to attain the objectives of the CACM and the ER.

1.1.10 The RDCTCS scope allows for exceptions upon common agreement by All Core TSOs.

1.2 The RDCTCS scope refers to other methodologies.

1.3 The RDCTCS scope should match a “significant impact”-test or the scope of DA and ID Core CCM.

1.4 The RDCTCS scope infringes Article 74(2) CACM and is inconsistent per se.

1.5 The RDCTCS scope is not in line with the CSAM.

1.6 The RDCTCS scope wrongly includes internal NEs.

1.7 The RDCTCS scope infringes Article 16(8), 16(4) and 16(13) ER.

1.8 The RDCTCS scope infringes Article 74(6)(a) CACM.

1.9 The RDCTCS scope infringes Article 74(6)(b) CACM.

1.10 The RDCTCS scope infringes Recital 12 CACM and 16(4) ER.

1.11 The RDCTCS scope infringes Article 35 CACM and 2(4) ER.

1.12 The RDCTCS contradicts the creation of the internal energy market.

1.13 The RDCTCS scope infringes the principle of subsidiarity.

Second Consolidated Plea – Unlawful inclusion of NEs covered by Action Plans in the RDCTCS scope.

2.1 The decision-making process leading-up to the Contested Decision.

2.2 The unlawful inclusion of NEs covered by Action Plans in the Contested Decision.

Third Consolidated Plea – Decomposition of flows.

3.1 The PFC method raises procedural concerns.

3.2 Flow decomposition in the Contested Decisions’ RDCTCS.

3.3 The PFC method ignores electrical distance, creates fictional flows and thereby obstructs any reasonable cost-attribution

3.4 The PFC method infringes Article 16(13) ER and the PPP.

3.5 The PFC method infringes Article 74(6)(c) CACM.

3.6 The PFC method infringes Article 74(6)(i) CACM, the principles of transparency and non-discrimination and Article 3(e) CACM.

3.7 The PFC method infringes Article 74(6)(a) CACM.

3.8 The PFC method infringes Article 74(5)(d) CACM.

3.9 The PFC method infringes Article 74(6)(e) CACM.

3.10 The PFC method infringes Article 74(6)(g) CACM.

²⁰ Appeal VI, para 340.

- 3.11 The PFC method infringes the objectives of the ER, the Electricity Directive and the objectives of Recitals (1) and (3) and Articles 3 and 74 CACM.
- 3.12 The PFC method infringes Article 74(6)(d) CACM.
- 3.13 The use of a CC GSK differs from the use of GSK for flow decomposition.
- 3.14 The use of a GSK violates Article 16(13) ER.
- 3.15 ACER erroneously requests TSOs to adjust the CC GSK in order to mitigate its effects in the flow decomposition process.
- 3.16 The use of a GSK violates Article 74(3) CACM and Article 74(6)(c) and (i) CACM.
- 3.17 The use of GSK violates Article 43 et ss Electricity Directive on ownership unbundling.
- 3.18 Restrictions on HVDC elements infringe the PPP.
- 3.19 Restrictions on HVDC elements infringe Article 74(6)(a) CACM.
- 3.20 Restrictions on HVDC elements infringe Article 74(6)(e) and 3(b) and (g) CACM.
- 3.21 Restrictions on HVDC elements infringe Articles 2(3) and 3(h) ER.

Fourth Consolidated Plea – Overestimation of loop flows and internal flows from importing zones.

- 4.1 The decomposition of flows contradicts the definitions of Article 2 of the Contested Decision's RDCTCS.
- 4.2 The decomposition of flows discriminates between importing zones and exporting zones and infringes Article 74(6)(c) and (i) CACM.
- 4.3 The decomposition of flows infringes Article 16(13) ER.

Fifth Consolidated Plea – Netting of flow components.

- 5.1 The decision-making process leading-up to the Contested Decision.
- 5.2 The lack of an additional netting process infringes Article (16)(11) ER.
- 5.3 The lack of an additional netting process infringes Article 16(13) ER and the PPP.
- 5.4 The lack of an additional netting process infringes Article 74(6)(a) CACM.
- 5.5 The lack of an additional netting process infringes Article 74(6)(b) CACM.
- 5.6 The lack of an additional netting process infringes Article 74(6)(c) CACM.
- 5.7 The lack of an additional netting process infringes Article 74(6)(e) CACM.
- 5.8 The lack of an additional netting process infringes Article 74(6)(f) CACM.
- 5.9 The lack of an additional netting process infringes Articles 74(6)(i), 74(5)(e) and 3(f) CACM.
- 5.10 The lack of an additional netting process infringes Article 16(8) ER.
- 5.11 The lack of an additional netting process infringes Article (74)(6)(d) CACM.
- 5.12 Appellant V's challenge of Article 6(1) of the Contested Decision's RDCTCS.

Sixth Consolidated Plea – Priority of loop flows above the threshold.

- 6.1 Characteristics of the priority stack.
- 6.2 The decision-making process leading-up to the Contested Decision.
- 6.3 The validity of prioritising LFs above the threshold in the priority stack.
- 6.4 The non-prioritised IFs are not caused by the LF polluting TSOs.
- 6.5 ACER should have used Option 2 of paragraph 128 of the Contested Decision.
- 6.6 Prioritisation of LFs above the threshold contradicts the EU internal market fostering renewable energies.
- 6.7 Prioritisation of LFs above the threshold infringes Article 16(13) ER and the PPP.
- 6.8 Prioritisation of LFs above the threshold infringes Article 74(6)(a) CACM.
- 6.9 Prioritisation of LFs above the threshold infringes Article 74(6)(b) CACM.
- 6.10 Prioritisation of LFs above the threshold infringes Article 74(6)(c) CACM.
- 6.11 Prioritisation of LFs above the threshold lacks consistency with LF contribution and PPP under SO.
- 6.12 Prioritisation of LFs above the threshold is incoherent with Article 16(8)ER.
- 6.13 Prioritisation of LFs above the threshold infringes the requirement to facilitate adherence to the LF contribution verification standard and the PPP.
- 6.14 Prioritisation of LFs above the threshold infringes the requirement to give efficient economic signals addressing network congestions.
- 6.15 Prioritisation of LFs above the threshold infringes the transparency principle.
- 6.16 Evidence adduced by Appellants II and VI concerning the prioritisation of LFs above the threshold.
- 6.17 Prioritisation of LFs above the threshold infringes Article 74(2) CACM.

Seventh Consolidated Plea – Threshold for acceptable loop flows.

- 7.1 Characteristics of the legitimate LF threshold.
- 7.2 The decision-making process leading-up to the Contested Decision.
- 7.3 The LF threshold requires a prior study and cannot be temporary.
- 7.4 The LF threshold's value should not be common but per BZB.
- 7.5 The LF threshold is set at an incorrect value.

- 7.6 The LF threshold should not be fixed but floating and infringes Article 16(8) ER.
- 7.7 The LF threshold infringes Article 15(2) ER.
- 7.8 The LF threshold infringes Article 74(6)(b) CACM with Article 16(8) and (13) ER.
- 7.9 The LF threshold should not be equally split among BZs.
- 7.10 The LF threshold should apply to LFs and IFs.
- 7.11 The LF threshold should comply with the principle of transparency.
- 7.12 No replacement of the LF threshold set by ACER.
- 7.14 The LF threshold set by ACER lacks due technical analysis.
- 7.15 The LF threshold infringes Article 74(6)(e) CACM.

Eighth Consolidated Plea – Polluter Pays Principle.

- 8.1 RDCTCS scope.
- 8.2 Unlawful inclusion of NEs covered by Action Plans in the RDCTCS scope.

Ninth Consolidated Plea – Lack of timescale to implement the RDCTCS.

Tenth Consolidated Plea – Definition of new implementation timeline.

Eleventh Consolidated Plea – Principle of proportionality.

- 11.1 Definition of a new implementation timeline.
- 11.2 RDCTCS scope.
- 11.3 Netting of flow components.
- 11.4 Priority of loop flows above the threshold.
- 11.5 Threshold for acceptable loop flows.
- 11.6 Cumulative effect of various infringements.

Twelfth Consolidated Plea – Principle of non-discrimination.

- 12.1 RDCTCS scope.
 - 12.2 Priority of loop flows above the threshold.
 - 12.3 Threshold for acceptable loop flows.
 - 12.4 Equal splitting of the common LF threshold.
 - 12.5 Netting of flow components.
 - 12.6 Restrictions on HVDC elements in flow decomposition.
 - 12.7 Cumulative effect of various infringements.
- Thirteenth Consolidated Plea – Lack of Impact Study.

Fourteenth Consolidated Plea – ACER exceeded its competence and infringed the principle of conferral.

- 14.1 RDCTCS scope.
- 14.2 Threshold for acceptable loop flows.
- 14.3 Title 3: Cost sharing principles.
- 14.4 Priority of loop flows above the threshold.
- 14.5 Review of RDCTCS.
- 14.6 Netting of flow components.

Fifteenth Consolidated Plea – ACER exercised NRAs' competences.

Sixteenth Consolidated Plea – Language plea.

- 16.1 Article 4 of Council Regulation No.1.
- 16.2 Article 3 of Council Regulation No.1.
- 16.3 Legal certainty.
- 16.4 Rights of defence.

Seventeenth Consolidated Plea – Duty to duly reason.

- 17.1 Due reasoning of the RDCTCS scope.
- 17.2 Due reasoning of the threshold for acceptable LFs.
- 17.3 Due reasoning of the prioritisation of LFs above the threshold.
- 17.4 Due reasoning of the choice of the PFC method.
- 17.5 Due reasoning of the Contested Decision in general.

Eighteenth Consolidated Plea – Duty of good administration.

- 18.1 Consultation of Core TSOs from September to November 2020.
- 18.2 Transfer of decision-making to ACER from NRAs should have triggered a separate public consultation.

First Consolidated Plea – Excessive scope of the RDCTCS and unlawful determination of XNEs.

89. Appellant II²¹ claims that the scope of the Contested Decision's RDCTCS infringes Article 74(2) and Recital 12 CACM and Article 16(13) ER as well as the principle of subsidiarity and Article 74(6)(b) CACM. In particular, Appellant II argues that the scope of the RDCTCS methodology (i) should expressly have been foreseen in the wording of the Contested Decision's RDCTCS, which should not refer to other methodologies (*in casu* based on Article 35 CACM and 76 SO) as regards its scope; (ii) should not match the scope of the coordinated security analysis (NEs \geq 220 kV) but should, in accordance with Articles 20 and 21 CACM, be limited to congestions between 2 BZs, i.e. covering CNECs (NEs with a zone-to-zone PTDF \geq 5%); (iii) is inconsistent in itself; (iv) should exclude internal NEs, their inclusion being discriminatory and (v) infringes the principle of subsidiarity.
90. Appellant III²² claims that the Contested Decision's RDCTCS adopted an excessive definition XNEs included into the CA process after mapping, contrary to Article 74(2) CACM and 16(13) ER. Appellant III claims that after mapping, the RDCTCS should not have included all other internal NEs than the costs for RAs exercised on CB elements (interconnectors) as this infringes Article 74(2) CACM and 16(13) ER (read in conjunction with Recital (12) and Articles 35(2), 74(6) CACM, with Recitals (20) and (21) and Articles 1, 2(4), 16(4) ER and with the scope of the RDCTCS, RDCT and ROSC). It furthermore argues that, even if the RDCTCS were to exclude all other internal NEs after mapping as requested by Appellant III, the Contested Decision's RDCTCS would still be unlawful because it should not have included internal CNEs, as this infringes Article 74(2) CACM and 16(13)ER. Appellant III adds that ACER did not take account of the possible impact on the Contested Decision of pending procedures T-283/19 and T-631/19 before the GCEU on the legal validity of the definition of internal CNEs in ACER's Decision 02/2019 on Core CCM.
91. Appellant IV²³ claims that the Contested Decision's RDCTCS infringes (i) Article 74(2) CACM, which limits cost-sharing solutions to XRAs (read in conjunction with Articles 1, 2(4), 16(8) and (13) and 61(4), (5) and (6) ER; Article 18(3) Old ER; and Articles 3 and 74(6) CACM); (ii) the principle of conferral and (iii) Article 74(6) CACM, which requires cost sharing methodologies to provide incentives to TSOs to invest effectively.
92. Appellant V²⁴ claims that the Contested Decision's RDCTCS should not have included internal lines with a PTDF $<$ 5% and sets wrong incentives for TSOs, infringing Articles 74 CACM, 16(13) ER (read in conjunction with Article 2(4) and 16(4) ER) and 291 TFEU.
93. Appellant VI²⁵ claims that the Contested Decision's RDCTCS should not have included NEs having a maximum zone-to-zone PTDF $<$ 5%, infringing Recital (35), Articles 2(4) and 16(13) ER and that ACER acted *ultra vires*, contrary to Article 5(2) TEU. Appellant VI adds that Contested Decision's RDCTCS fails to align the definition of XNEs with the Core CCM definition of CNECs and infringes Recital 12 and Articles 74(2) and (6) CACM, and Recital

²¹ Appeal II, Plea 6, paras 122-150.

²² Appeal III, Plea 1, paras 26-125.

²³ Appeal IV, Plea 1, paras 29-65.

²⁴ Appeal V, Plea 1, paras 22-45.

²⁵ Appeal VI, Pleas 1, 3(1) and 5, paras 93-124, 154-166 and 209-225.

(31) and Articles 2(4), 15(1), (2), (3) and (6), 16(8) and 16(13) ER. Appellant VI also claims that scope infringes the PPP.

94. ACER's Defence²⁶ rejects all pleas. It alleges that the Contested Decision's RDCTCS, defining XRAs and XNECs eligible for cost sharing, is in line with the applicable regulatory framework and that the scope of the XNECs should be wider than the scope of the CNEs used for the DA and ID CC process. It underlines the intrinsic link between RDCTCS and OS, given that (i) the RDCTCS methodology taken by virtue of Article 74 CACM determines how costs are shared of costly XRAs (RDCTs) taken under Article 35 CACM are shared at regional level; (ii) the RDCT taken by virtue of Article 35 CACM and ROSC taken by virtue of Article 76 SO identify the most effective XRAs (i.e. relieving OS violations) at regional level and (iii) RDCTs are an input for the CC process set out in Articles 20 to 30 CACM. In this respect, ACER stresses that one of the main objectives of the CACM according to its Article 3 is OS. It adds that the CACM's legal basis, namely Article 18 Old ER, which refers to Article 8(6) Old ER, relates to OS issues. The Defence argues that the only costly XRAs are RDCTs (all XRAs under Article 35 CACM are XRAs under Article 76 SO), that the RDCTCS only covers RDCTs and that the RDCTCS must provide cost sharing solutions for all XRAs coordinated under the CROSA process which relieve physical congestion on XNECs. The CROSA process of the ROSC consists of a systematic coordination, pooling all available XRAs together in order to identify the optimal XRAs to solve congestions in the Core CCR. Finally, it alleges that Article 16(13) ER does not limit the scope of the RDCTCS methodology to RAs relieving physical congestion on interconnectors or CNECs. ACER considers that Article 16(13) ER provides that (i) the polluting flows are LFs and IFs from inside a CCR; (ii) the PPP applies; (iii) under a threshold, the OPP applies instead of the PPP; (iv) as All Core TSOs have to analyse the threshold for each individual BZB, there is no threshold for IFs because there are no IFs on BZBs and (v) the RDCTCS applies to congestion between 2 BZs observed but does not limit the scope of the RDCTCS *per se* to congestion between 2 BZs observed. In its view, other flows than LFs and IFs from inside a CCR – e.g. LFs from outside a CCR – contribute to congestion between 2 BZs observed, require the activation of XRAs under CROSA process and require a cost sharing process.
95. Intervener I intervenes in the First Consolidated Plea on behalf of Appellant III.
96. Interveners II, III, IV, V and VI intervene in the First Consolidated Plea on behalf of the Defendant.
97. Article 74 CACM, entitled "*Redispatching and countertrading cost sharing methodology*", reads as follows:
1. *No later than 16 months after the decision on the capacity calculation regions is taken, all TSOs in each capacity calculation region shall develop a proposal for a common methodology for redispatching and countertrading cost sharing.*
 2. *The redispatching and countertrading cost sharing methodology shall include cost-sharing solutions for actions of cross-border relevance.*
 3. *Redispatching and countertrading costs eligible for cost sharing between relevant TSOs shall be determined in a transparent and auditable manner.*
 4. *The redispatching and countertrading cost sharing methodology shall at least:*
 - (a) *determine which costs incurred from using remedial actions, for which costs have been considered in the capacity calculation and where a common framework on the use of such actions has been established, are eligible for sharing between all the TSOs of a capacity calculation region in accordance with the capacity calculation methodology set out in Articles 20 and 21;*
 - (b) *define which costs incurred from using redispatching or countertrading to guarantee the firmness of cross-zonal capacity are eligible for sharing between all the TSOs of a capacity calculation region in accordance with the capacity calculation methodology set out in Articles 20 and 21;*
 - (c) *set rules for region-wide cost sharing as determined in accordance with points (a) and (b).*
 5. *The methodology developed in accordance with paragraph 1 shall include:*
 - (a) *a mechanism to verify the actual need for redispatching or countertrading between the TSOs involved;*
 - (b) *an ex post mechanism to monitor the use of remedial actions with costs;*

²⁶ Defence, paras 203-298 and 312-331.

- (c) a mechanism to assess the impact of the remedial actions, based on operational security and economic criteria;
- (d) a process allowing improvement of the remedial actions;
- (e) a process allowing monitoring of each capacity calculation region by the competent regulatory authorities.

6. The methodology developed in accordance with paragraph 1 shall also:

- (a) provide incentives to manage congestion, including remedial actions and incentives to invest effectively;
- (b) be consistent with the responsibilities and liabilities of the TSOs involved;
- (c) ensure a fair distribution of costs and benefits between the TSOs involved;
- (d) be consistent with other related mechanisms, including at least: (i) the methodology for sharing congestion income set out in Article 73; (ii) the inter-TSO compensation mechanism, as set out in Article 13 of Regulation (EC) No 714/2009 and Commission Regulation (EU) No 838/2010 (1);
- (e) facilitate the efficient long-term development and operation of the pan-European interconnected system and the efficient operation of the pan-European electricity market;
- (f) facilitate adherence to the general principles of congestion management as set out in Article 16 of Regulation (EC) No 714/2009;
- (g) allow reasonable financial planning;
- (h) be compatible across the day-ahead and intraday market time-frames; and
- (i) comply with the principles of transparency and non-discrimination.

7. By 31 December 2018, all TSOs of each capacity calculation region shall further harmonise as far as possible between the regions the redispatching and countertrading cost sharing methodologies applied within their respective capacity calculation region.”

98. Article 16 Old ER has been replaced by Article 16 ER (“General principles of capacity allocation and congestion management”), which reads as follows:

“1. Network congestion problems shall be addressed with non-discriminatory market-based solutions which give efficient economic signals to the market participants and transmission system operators involved. Network congestion problems shall be solved by means of non-transaction-based methods, namely methods that do not involve a selection between the contracts of individual market participants. When taking operational measures to ensure that its transmission system remains in the normal state, the transmission system operator shall take into account the effect of those measures on neighbouring control areas and coordinate such measures with other affected transmission system operators as provided for in Regulation (EU) 2015/1222.

2. Transaction curtailment procedures shall be used only in emergency situations, namely where the transmission system operator must act in an expeditious manner and redispatching or countertrading is not possible. Any such procedure shall be applied in a non-discriminatory manner. Except in cases of force majeure, market participants that have been allocated capacity shall be compensated for any such curtailment.

3. Regional coordination centres shall carry out coordinated capacity calculation in accordance with paragraphs 4 and 8 of this Article, as provided for in point (a) of Article 37(1) and in Article 42(1). Regional coordination centres shall calculate cross-zonal capacities respecting operational security limits using data from transmission system operators including data on the technical availability of remedial actions, not including load shedding.

Where regional coordination centres conclude that those available remedial actions in the capacity calculation region or between capacity calculation regions are not sufficient to reach the linear trajectory pursuant to Article 15(2) or the minimum capacities provided for in paragraph 8 of this Article while respecting operational security limits, they may, as a measure of last resort, set out coordinated actions reducing the cross-zonal capacities accordingly. Transmission system operators may deviate from coordinated actions in respect of coordinated capacity calculation and coordinated security analysis only in accordance with Article 42(2). By 3 months after the entry into operation of the regional coordination centres pursuant to Article 35(2) of this Regulation and every three months thereafter, the regional coordination centres shall submit a report to the relevant regulatory authorities and to ACER on any reduction of capacity or deviation from coordinated actions pursuant to the second subparagraph and shall assess the incidences and make recommendations, if necessary, on how to avoid such deviations in the future. If ACER concludes that the prerequisites for a deviation pursuant to this paragraph are not fulfilled or are of a structural nature, ACER shall submit an opinion to the relevant regulatory authorities and to the Commission. The competent regulatory authorities shall take appropriate action against transmission system operators or regional coordination centres pursuant to Article 59 or 62 of Directive (EU) 2019/944 if the prerequisites for a deviation pursuant to this paragraph were not fulfilled.

Deviations of a structural nature shall be addressed in an action plan referred to in Article 14(7) or in an update of an existing action plan.

4. *The maximum level of capacity of the interconnections and the transmission networks affected by cross-border capacity shall be made available to market participants complying with the safety standards of secure network operation. Counter-trading and redispatch, including cross-border redispatch, shall be used to maximise available capacities to reach the minimum capacity provided for in paragraph 8. A coordinated and non-discriminatory process for cross-border remedial actions shall be applied to enable such maximisation, following the implementation of a redispatching and counter-trading cost-sharing methodology.*
5. *Capacity shall be allocated by means of explicit capacity auctions or implicit auctions including both capacity and energy. Both methods may coexist on the same interconnection. For intraday trade, continuous trading, which may be complemented by auctions, shall be used.*
6. *In the case of congestion, the valid highest value bids for network capacity, whether implicit or explicit, offering the highest value for the scarce transmission capacity in a given timeframe, shall be successful. Other than in the case of new interconnectors which benefit from an exemption under Article 7 of Regulation (EC) No 1228/2003, Article 17 of Regulation (EC) No 714/2009 or Article 63 of this Regulation, establishing reserve prices in capacity-allocation methods shall be prohibited.*
7. *Capacity shall be freely tradable on a secondary basis, provided that the transmission system operator is informed sufficiently in advance. Where a transmission system operator refuses any secondary trade (transaction), this shall be clearly and transparently communicated and explained to all the market participants by that transmission system operator and notified to the regulatory authority.*
8. *Transmission system operators shall not limit the volume of interconnection capacity to be made available to market participants as a means of solving congestion inside their own bidding zone or as a means of managing flows resulting from transactions internal to bidding zones. Without prejudice to the application of the derogations under paragraphs 3 and 9 of this Article and to the application of Article 15(2), this paragraph shall be considered to be complied with where the following minimum levels of available capacity for cross-zonal trade are reached:*
 - (a) *for borders using a coordinated net transmission capacity approach, the minimum capacity shall be 70 % of the transmission capacity respecting operational security limits after deduction of contingencies, as determined in accordance with the capacity allocation and congestion management guideline adopted on the basis of Article 18(5) of Regulation (EC) No 714/2009;*
 - (b) *for borders using a flow-based approach, the minimum capacity shall be a margin set in the capacity calculation process as available for flows induced by cross-zonal exchange. The margin shall be 70 % of the capacity respecting operational security limits of internal and cross-zonal critical network elements, taking into account contingencies, as determined in accordance with the capacity allocation and congestion management guideline adopted on the basis of Article 18(5) of Regulation (EC) No 714/2009. The total amount of 30 % can be used for the reliability margins, loop flows and internal flows on each critical network element.*
9. *At the request of the transmission system operators in a capacity calculation region, the relevant regulatory authorities may grant a derogation from paragraph 8 on foreseeable grounds where necessary for maintaining operational security. Such derogations, which shall not relate to the curtailment of capacities already allocated pursuant to paragraph 2, shall be granted for no more than one-year at a time, or, provided that the extent of the derogation decreases significantly after the first year, up to a maximum of two years. The extent of such derogations shall be strictly limited to what is necessary to maintain operational security and they shall avoid discrimination between internal and cross-zonal exchanges. Before granting a derogation, the relevant regulatory authority shall consult the regulatory authorities of other Member States forming part of the affected capacity calculation regions. Where a regulatory authority disagrees with the proposed derogation, ACER shall decide whether it should be granted pursuant to point (a) of Article 6(10) of Regulation (EU) 2019/942. The justification and reasons for the derogation shall be published. Where a derogation is granted, the relevant transmission system operators shall develop and publish a methodology and projects that shall provide a long-term solution to the issue that the derogation seeks to address. The derogation shall expire when the time limit for the derogation is reached or when the solution is applied, whichever is earlier.*
10. *Market participants shall inform the transmission system operators concerned within a reasonable period in advance of the relevant operational period whether they intend to use allocated capacity. Any allocated capacity that is not going to be used shall be made available again to the market, in an open, transparent and non-discriminatory manner.*
11. *As far as technically possible, transmission system operators shall net the capacity requirements of any power flows in opposite directions over the congested interconnection line in order to use that line to its maximum capacity. Having full regard to network security, transactions that relieve the congestion shall not be refused.*
12. *The financial consequences of a failure to honour obligations associated with the allocation of capacity shall be attributed to the transmission system operators or NEMOs who are responsible for such a failure.*

Where market participants fail to use the capacity that they have committed to use, or, in the case of explicitly auctioned capacity, fail to trade capacity on a secondary basis or give the capacity back in due time, those market participants shall lose the rights to such capacity and shall pay a cost-reflective charge. Any cost-reflective charges for the failure to use capacity shall be justified and proportionate. If a transmission system operator does not fulfil its obligation of providing firm transmission capacity, it shall be liable to compensate the market participant for the loss of capacity rights. Consequential losses shall not be taken into account for that purpose. The key concepts and methods for the determination of liabilities that accrue upon failure to honour obligations shall be set out in advance in respect of the financial consequences, and shall be subject to review by the relevant regulatory authority.

13. When allocating costs of remedial actions between transmission system operators, regulatory authorities shall analyse to what extent flows resulting from transactions internal to bidding zones contribute to the congestion between two bidding zones observed, and allocate the costs based on the contribution to the congestion to the transmission system operators of the bidding zones creating such flows except for costs induced by flows resulting from transactions internal to bidding zones that are below the level that could be expected without structural congestion in a bidding zone.

That level shall be jointly analysed and defined by all transmission system operators in a capacity calculation region for each individual bidding zone border, and shall be subject to the approval of all regulatory authorities in the capacity calculation region.”

99. Article 16(13) ER contains the Polluter Pays Principle (“PPP”) : it requires NRAs to allocate costs to the TSOs on the basis of whether they create flows from internal BZ transactions that contribute to the congestion between 2 BZs observed (above a threshold).

100. Article 1 of the RDCTCS reads as follows:

“Article 1 - Subject matter and scope.

1. This cost sharing methodology is the common methodology for redispatching and countertrading cost sharing in accordance with Article 74 of the CACM Regulation. It covers the sharing of costs of cross-border relevant redispatching and countertrading actions activated pursuant to the coordination process as defined in the methodology pursuant to Article 35 of the CACM Regulation and the methodology pursuant to Article 76 of the SO Regulation. If this coordination process and its optimisation results in activation of other costly remedial actions, these costs shall also be included in the total costs to be shared in accordance with this methodology. This cost sharing methodology shall apply to all Core TSOs.

2. This cost sharing methodology shall also apply to third country TSO(s), if such TSO(s) have signed an agreement with all Core TSOs that they shall comply with this cost sharing methodology, as well as the methodology pursuant to Article 35 of the CACM Regulation and the methodology pursuant to Article 76 of the SO Regulation and accept all the rights and obligations stemming from them. In such case the reference to Core TSO(s) and Core CCR in this methodology shall also include such third country TSO(s).”

101. Articles 3 of the RDCTCS reads as follows:

“Article 3. XRAs and XNECs eligible for cost sharing.

1. This cost sharing methodology covers the sharing of costs and revenues of the cross-border relevant redispatching and countertrading actions that are determined as eligible for cost sharing in accordance with the methodology pursuant to Article 35 of the CACM Regulation and the methodology pursuant to Article 76 of the SO Regulation.

2. In accordance with Article 74(4)(b) of the CACM Regulation, all cross-border relevant redispatching and countertrading actions activated pursuant to the coordination process as defined in the methodology pursuant to Article 35 of the CACM Regulation and the methodology pursuant to Article 76 of the SO Regulation shall be considered as guaranteeing the firmness of cross-zonal capacities calculated in accordance with the capacity calculation methodology pursuant to Articles 20 and 21 of the CACM Regulation.

3. The costs and revenues of all cross-border relevant redispatching and countertrading actions activated pursuant to the common regional coordination and optimisation process as defined in the methodology pursuant to Article 35 of the CACM Regulation and the methodology pursuant to Article 76 of the SO Regulation shall be considered as eligible for cost sharing.

4. All cross-border relevant network elements shall be eligible for cost sharing in accordance with this cost sharing methodology.

5. In accordance with Article 74(4)(a) of the CACM Regulation, the costs of redispatching and countertrading actions, as well as other remedial actions considered in the capacity calculation, shall not be eligible for cost sharing, unless these actions have been confirmed to be activated within the common regional RAO process as defined in paragraph 3.

6. The eligible costs and revenues shall include only the costs and revenues of the cross-border relevant redispatching and countertrading actions that are determined as eligible for cost sharing in accordance with the methodology pursuant to Article 35 of the CACM Regulation and the methodology pursuant to Article 76 of the SO Regulation. In particular, any capacity and reservation costs shall not be eligible for cost sharing.

7. *The eligible costs and revenues shall be auditable and transparent.*
8. *The total costs of cross-border relevant redispatching and countertrading actions eligible for cost sharing shall be determined as the netted sum of costs and revenues arising from the cross-border relevant redispatching and countertrading actions activated pursuant to the common regional RAO process as defined in the methodology pursuant to Article 35 of the CACM Regulation and the methodology pursuant to Article 76 of the SO Regulation.”*
102. Article 2(2)(j) of the RDCTCS defines CB relevant network element (“XNEs”) as “*a network element identified as cross-border relevant and on which operational security violations need to be managed in a coordinated way*”.
103. Article 2(2)(l) of the RDCTCS defines eligible XNE or eligible XNEC as “*XNE or XNEC, which is eligible for cost sharing in accordance with this cost sharing methodology*”.
104. Article 7(1) of the RDCTCS states, with respect to the distribution of costs on XNECs to TSOs, that “*All Core TSOs shall use the flow components on each eligible XNEC to calculate the share of the total costs attributed to eligible XNEC that shall be attributed to each TSO from the Core CCR. The calculations shall consist of the following steps:*
- (i) Application of threshold(s) as described in paragraphs 2 to 5;*
 - (ii) Identification of contributions to congestion as described in paragraph 6; and*
 - (iii) Distribution of costs to bidding zones and TSOs as described in paragraphs 7 and 8.”*
105. It appears from the above that the Contested Decision’s RDCTCS for Core CCR covers the sharing of costs of RDCT actions activated pursuant to the coordination and optimisation processes defined in Article 35 CACM and Article 76 SO.
106. The scope of the Contested Decision’s RDCTCS refers to and matches the scope of (i) the common RDCT methodology (“RDCT”) that has been adopted in ACER Decision 35/2020 of 4 December 2020 (“ACER Decision 35/2020”²⁷) in accordance with Article 35 CACM; and (ii) the common methodology for regional operational security coordination (“ROSC”) that has been adopted in ACER Decision 33/2020 of 4 December 2020 (“ACER Decision 33/2020”²⁸) in accordance with Article 76 of Regulation (EU) 2017/1485 establishing a guideline on electricity transmission system operation (“SO”).
107. The scope of the RDCT is to be found in Article 5(1) RDCT, which states that XNEs are (i) all critical network elements (“CNEs”) included in the final list of CNEs in the Core day-ahead and intraday common capacity calculation methodologies (“DA Core CCM and ID Core CCM”) in accordance with CACM (Annexes I and II to ACER Decision 02/2019²⁹) and (ii) all other NEs ≥ 220 kV within the control area of Core TSOs. Exceptions can be agreed upon by Core TSOs.
108. The scope of the ROSC is to be found in Article 5(1) ROSC, which similarly states that XNEs are (i) all CNEs included in the final list of CNEs in the DA Core CCM and ID Core CCM of Core in accordance with CACM (Annexes I and II to ACER Decision 02/2019) and (ii) all other NEs ≥ 220 kV within the control area of Core TSOs. Exceptions can be agreed upon by Core TSOs.
109. Graphically, the scope of the RDCTCS is as follows:

²⁷ https://acer.europa.eu/Official_documents/Acts_of_the_Agency/Individual%20decisions/ACER%20Decision%2035-2020%20on%20Core%20RDCT%2035.pdf

²⁸ https://acer.europa.eu/Official_documents/Acts_of_the_Agency/Individual%20decisions/ACER%20Decision%2033-2020%20on%20Core%20ROSC.pdf

²⁹ https://www.acer.europa.eu/Official_documents/Acts_of_the_Agency/Individual%20decisions/ACER%20Decision%2002-2019%20on%20CORE%20CCM.pdf

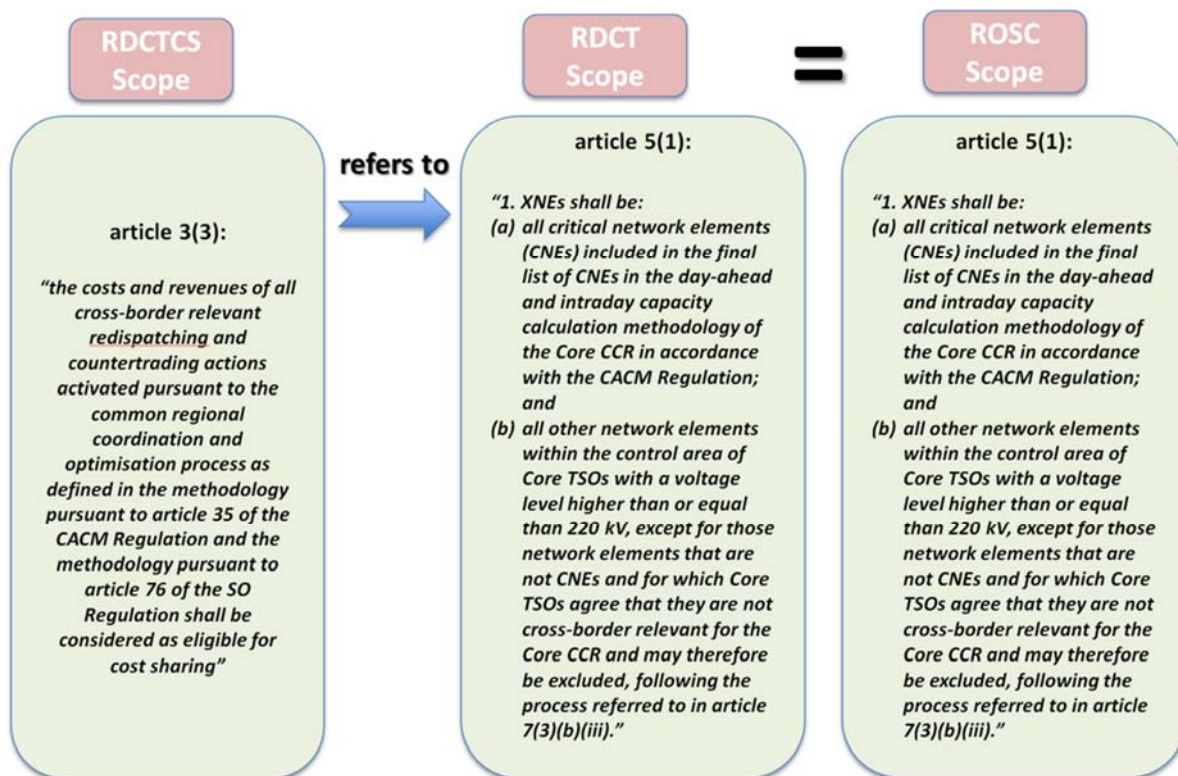

Source: Board of Appeal.

110. The scope of the ROSC, RDCT and RDCTCS is therefore as follows:

XNEs =

Includes: • **all CNEs (CCM)** (according to a yearly list of CNEs):

- all CZ NEs
- all internal NEs, defined by All Core TSOs, with a BZ-to-BZ PTDF $\geq 5\%$

• **other NEs ≥ 220 kV**

Excludes: XNEs that are not CNEs, i.e.:

- radial lines, distribution NEs, transformers with secondary voltage < 220 kV
- other NEs as commonly agreed upon by All Core TSOs
- XNEs that are part of another CCR CROSA (for TSOs belonging to more than one CCR)

Source: Board of Appeal.

1.1 The Board of Appeal's appraisal of the RDCTCS scope.

1.1.1 ACER's regulatory supervision when adopting the Contested Decision.

111. First, All Core TSO's RDCTCS Proposal provided in its Title II, "Eligible Costs for Cost Sharing", Article 4, the "Eligible Costs":

"1. This Cost Sharing Methodology covers costs and revenues incurred by Core TSOs from using redispatching and countertrading, including measures identified as **actions of cross-border relevance as defined in the Core RD and CT Methodology**. These are used **to guarantee the firmness of crosszonal capacity in accordance with article 74(4)b of CACM guideline and to ensure security of supply**, taking into account the exceptions pursuant to paragraph 3 of Article 4 of this methodology. The eligible costs and revenues:

- a. shall be auditable and transparent;
- b. shall occur from activations **as a result of the process in accordance with the methodology pursuant to article 76(1) of SO guideline**. These costs and revenues shall be: i. in case of countertrading, the incurred costs to solve congestions, consisting out of costs and revenues for activated countertrading resources as

described in the article 6 of Core RD and CT Methodology; ii. in case of redispatching, the incurred costs to solve congestions, consisting of costs and revenues for upward and downward regulated energy, provided individually for each upward or downward activation as described in the article 11 of Core RD and CT Methodology.

c. shall include only the costs and revenues realized by the activation of redispatching and countertrading measures as defined in the Core RD and CT Methodology. Capacity costs are not eligible for cost sharing in accordance with article 11(3) of the Core RD and CT Methodology.

2. The total costs resulting from the eligible costs defined in paragraph 1 of this Article are determined as the netted sum of both, the countertrading costs defined in paragraph 1(b)(i) and the redispatching costs defined in paragraph 1(b)(ii).

3. Some costs related to activation of CT and RD measures are not eligible for cost sharing. Costs noneligible for cost sharing are the costs incurred by the activation of remedial actions related to: a. uncoordinated LTA as not in line with the methodology pursuant article 10(1) FCA guideline (if applicable); b. emergency requests. In particular, but not limited to this situation, a TSO can face a critical situation, without being able to solve it by itself. This TSO can ask neighbouring Core TSOs for their support. Such request can lead to overloads on internal or external network elements, which need to be relieved via CT and RD measures. Costs related to implement the request are paid by the TSO that initiated the request; c. other reasons than violation of thermal limits following N or N-1 situations as defined in the methodology pursuant to article 75(1) SO guideline; d. Uncoordinated Remedial Actions by Core TSO that lead to overload on some network elements.

4. Other costs related to activation of CT and RD measures not eligible for cost sharing are the costs incurred by: a. the activation of uncoordinated CT and RD measures; b. the activation of remedial actions decided during the capacity calculation process defined in the Core DA and ID CC Methodologies (if applicable). In particular, but not limited to this situation, during (day-ahead or intraday) capacity calculation, a TSO can decide to transparently include CT and RD measures that it has at its disposal (in its own grid or through an agreement with another TSO(s)) to enlarge the capacity domain.

5. Those costs not eligible for cost sharing shall be borne by: a. Core TSOs that have implemented these measures for those costs described in the paragraphs 3(c), 4(a) and 4(b) of this Article; b. Core TSOs that have requested the activation of emergency requests or uncoordinated LTA in the paragraphs 3(a) and 3(b) of this Article; c. Core TSOs that applied Uncoordinated Remedial Actions leading to the activation of countertrading and redispatching measures according to paragraph 3(d) of this Article.

6. The optimisation realised under the scope of the methodology pursuant to article 76(1) of the SO guideline solves congestions on network elements which can either be XBRNE or non-XBRNE. The costs eligible for cost sharing as considered in this methodology are defined as the costs mapped to the XBRNE pursuant to Article 9. The costs mapped to non-XBRNE shall be borne by Core TSOs in which control area the network element is located.

7. Total costs for cost sharing shall be determined on bidding zone level. These costs per bidding zone shall be allocated to the responsible Core TSOs, active in the respective bidding zone.” (emphasis added)

112. All Core TSO’s RDCTCS Proposal consequently referred to actions of CB relevance (“XRAs”) as defined in the RDCT, whilst also acknowledging the link between the RDCTCS, on the one hand, and security of supply and CROSA, on the other hand.

113. All Core TSOs’ RDCT Proposal³⁰, in turn, stated in its Article 4 that XBRNEs were transmission systems of ≥ 220 kV “which were fully or partly located in their own control area” and added that all XBRNEs were “subject to RD and CT cost sharing.”

114. All Core TSOs’ RDCT Proposal, which All Core TSOs published on the same day as their RDCTCS Proposal (22 February 2019) defined XBRNEs as follows:

“1. All XBRNE selected according to Paragraphs 2 to 6 are subject to RD and CT cost sharing.

2. Each Core TSO shall define a list of initial XBRNE of transmission systems of 220 kV and higher voltages, which are fully or partly located in their own control area. Each Core TSO shall define this list based on operational experience. The lists of initial XBRNE shall include all cross-zonal network elements and may include also internal network elements, whereby these elements may be an overhead line, an underground cable, or a transformer. This list shall be updated at least on a yearly basis and shall be updated in case of significant network developments and related topology changes.

3. Each Core TSO shall define a list of proposed contingencies used in operational security analysis in accordance with Article 33 of the SO guideline. The contingencies of a Core TSO shall be located within the observability area of that Core TSO. This list shall be updated at least on a yearly basis and in case of network

³⁰<https://eepublicdownloads.entsoe.eu/clean-documents/Network%20codes%20documents/Implementation/ccr/methodologies/core/cacm-deliverables/coordinated-rd-and-ct-art-35/201902-core-cacm-35-methodology.pdf>.

developments and related topology changes. A contingency can be an unplanned outage of a: a. (HVDC) line, cable, or transformer; b. busbar; c. generating unit; d. load; e. set of the aforementioned contingencies.

4. Each Core TSO shall associate the contingencies and the corresponding observability area established pursuant to Paragraph 3 with the XBRNE established pursuant to Paragraph 2 following the rules established in accordance with the methodology pursuant to Article 75(1) of SO guideline. Until such rules are established and enter into force, the association of contingencies to XBRNE shall be based on each Core TSO's operational experience.

5. Each Core TSO shall define the list of XBRNE as follows: a. From the list of initial XBRNE, it shall remove those internal XBRNE, for which the maximum zone-to-zone power transmission distribution factor (hereafter referred to as "PTDF") is not higher than five percent. The estimation of the zone-to-zone PTDF is described in Annex 1 of this methodology; b. From the remaining list of XBRNE, it shall remove those internal XBRNE which are not included in the list of internal XBRNE pursuant to Paragraph 6. This step shall not be performed until 30 days after the decision on the proposal for amendment of this methodology defining the list of internal XBRNE to be included in the list of XBRNE pursuant to Paragraph 6 becomes effective.

6. In the amended methodology in accordance with Article 19 Paragraph 4, Core TSOs shall jointly develop the criteria for the internal network elements to be excluded from the remaining XBRNE. In this development, Core TSOs will perform an impact assessment of increasing the threshold of maximum zone-to-zone PTDF for exclusion of internal XBRNE pursuant to Paragraph 5.a up to 10% at a later stage." (emphasis added).

115. Said definition of XBRNEs clearly acknowledges a link between the RDCTCS and OS.

116. However, All Core TSOs' RDCTCS Proposal made a distinction between XNEs as defined in the RDCT, called "XBRNE" in the Proposal, on the one hand, and non-XBRNE, on the other hand. Article 9 of All Core TSOs' RDCTCS Proposal stated:

"1. The remedial action optimisation realised under the scope of the methodology pursuant to article 76(1) SO guideline solves congestions on network elements which can be XBRNE or non-XBRNE.

2. The cost of applied remedial actions shall be mapped to the congested elements of the Core bidding zones relieved by the remedial action optimisation.

3. Mapping shall be performed on XBRNE and non-XBRNE in an hourly resolution.

4. Core TSOs shall take into account in the mapping process: a. the final costs resulting from remedial actions activated as an output of the remedial action optimization according to the methodology pursuant of article 76(1); b. the CGM used in the relevant CSA; c. the outputs of the relevant CSA regarding congested elements.

5. The results of the mapping shall be hourly costs allocated to XBRNEs and non-XBRNEs in [€]."

Article 10 of All Core TSOs' RDCTCS Proposal stated:

"1. Determine bidding zone costs per network element: a. To obtain the costs in [€] for each network element per bidding zone and hour, the costs mapped to each network element shall be multiplied with the respective BZ-shares per network element; b. For XBRNEs, the BZ-shares shall be the outcomes of transformation (as defined in Article 8); c. For non-XBRNEs, the bidding zone in which the non-XBRNE is located shall receive the full costs mapped to the element (100% of that bidding zone).

2. Aggregation of costs on bidding zone level: a. To obtain the final costs per bidding zone, the costs per bidding zone and hour are summed up for all hours and congested network elements, for which remedial actions have been activated. The result shall be one value per Core bidding zone in [€]"

117. All Core TSOs' RDCTCS Explanatory Document³¹ merely stressed that the input for the XBRNE was related to the methodology in accordance with Article 35(2) CACM. It furthermore referred to Article 14 of All Core TSO's RDCT Proposal³², which referred to the activation in DA and ID processes and considered the possibility for an additional request for coordination and reconsideration of ordered RDCT in the following cases "by the RA Connecting TSO(s), in case a provider of the RD or CT resource is not able to deliver the amount of Ordered Redispatching and/ or Ordered Countertrading or only parts of it on short notice; case an improved grid situation occurs. This may lead to cancellation or reduction of Ordered Redispatching and/ or Ordered Countertrading if it is technically and operationally feasible and when economically proven to be efficient".

118. All Core NRAs' RDCTCS Non-Paper evidenced divergent positions³³ (XBRNEs being defined either as interconnectors or as CNEs as per CCM or as NEs ≥ 220 kV).

119. Subsequently, All Core TSOs' RDCTCS Non-Paper³⁴ evidenced divergent positions. Yet again, All Core TSOs acknowledged the link between the RDCTCS and OS, with an express

³¹ Annex 13 to the Defence, p. 4 and 5.

³² <https://eepublicdownloads.entsoe.eu/clean-documents/Network%20codes%20documents/Implementation/ccr/methodologies/core/cacm-deliverables/coordinated-rd-and-ct-art-35/201902-core-cacm-35-methodology.pdf>

³³ Annex A.3.2 to Appeal VI. See also, Contested Decision, para 23.

³⁴ Annex 79 to the Defence.

referral to Article 15 of ACER Decision 07/2019 containing the EU-wide CROSA methodology, adopted under Article 75 SO (“CSAM”³⁵) in its section “*Elements relevant for cost-sharing (XBRNE)*”: “*In accordance with article 15(2) of the methodology pursuant to article 75(1) SO Regulation, TSOs shall define the rules and/or criteria to establish the cross-border relevant network elements (XNEs) for which the costs attributed to them shall be shared among the involved TSOs. Core TSOs have referred to the methodology pursuant to article 35(1) CACM Regulation to define these principles. Core TSOs have named these XNEs relevant for cost-sharing in an earlier stage already XBRNEs (before the methodology in pursuance with article 75(1) went into force)*”. It listed the different positions of Core TSOs: 9 TSOs were of the opinion that only tie-lines had to be considered and 7 TSOs were of the opinion that tie-lines and internal NEs had to be considered, though with different nuances. Some considered XBRNEs to be CNECs considered in DA Core CCM. Others considered XBRNEs to be at least current CNECs, i.e. determined by zone-to zone PTDF $\geq 5\%$ and at most XNEs from ROSC, i.e. all overloaded elements ≥ 220 kV. Others considered XBRNEs to be internal NEs over which LFs and unscheduled PST flows exceed a LF threshold. Others considered XBRNEs to be tie-lines and internal NEs with PTDF $\geq 5\%$. Others considered XBRNEs to be XNEs defined in order to ensure consistency between the RDCTCS and the ROSC.

120. Article 15 of the CSAM, entitled “*Identification of cross-border relevant network elements and remedial actions*” states:

“1. *The cross-border relevant network elements (‘XNEs’) shall be all critical network elements (‘CNEs’) and other network elements above the voltage level defined by TSOs, except for those elements for which all TSOs in a CCR agree that they are not cross-border relevant for the concerned CCR and may therefore be excluded.*

2. *The common provisions for regional operational security coordination pursuant to Article 76(1) of the SO Regulation shall define the rules and/or criteria to establish the XNEs for which the costs attributed to them shall be shared among the involved TSOs and the XNEs for which the costs attributed to them shall be covered solely by the XNE connecting TSO(s), taking into account rules for cost sharing in accordance with Article 74 of the CACM Regulation.*”

121. ACER carried out the regulatory supervision of All Core TSOs’ RDCTCS Proposal under the CACM which had been referred to it by All NRAs in accordance with the CACM’s referral procedure. In so doing, ACER found that the scope of the RDCTCS was not in accordance with Article 74(2) CACM, which requires the RDCTCS to “*include cost-sharing solutions for actions of cross-border relevance*”.

122. In light of the bottom-up decision-making process leading-up to the Contested Decision, the Board of Appeal concludes that, when carrying out its functions of regulatory supervision, ACER had to take account of the fact that All Core TSOs’ RDCTCS Proposal linked cost sharing of the RDCTCS to OS, whilst taking account of the views of All Core NRAs.

1.1.2 RAs in the zonal market model.

123. The EU has adopted a zonal electricity market design, which prioritizes *de facto* internal trade over CZ trade.

124. Hence, there is a need for CA and CM, as foreseen by the CACM, which includes “*the requirements for the establishment of common methodologies for determining the volumes of capacity simultaneously available between bidding zones, criteria to assess efficiency and a review process for defining bidding zones*” (Article 1(1) CACM).

125. There is a variety of CACM measures. RAs are short-term CACM measures. BZ reconfiguration or network infrastructure investments are mid-term or long-term measures. The more remote from the time of delivery the choice of a CACM measure needs to be made, the more CACM measures are available.

126. RAs are short-term preventive or corrective CM measures to maintain OS, as a result of an operational planning process, and are necessarily preceded by OSA. They can be costly or non-costly. The ER favours the use of non-costly RAs.

³⁵ <https://eepublicdownloads.entsoe.eu/clean-documents/Network%20codes%20documents/Implementation/ccr/methodologies/core/cacm-deliverables/coordinated-rd-and-ct-art-35/20190117-core-report-harmonization-cacm-353-nrasfinal.pdf>

127. RDCTs are costly.
128. RDs consist of the alteration of the generation and/or load pattern in order to change physical flows in the transmission system and relieve a physical congestion (Article 2(26) ER).
129. CTs consist of CZ exchange initiated by TSOs between 2 BZs to relieve physical congestion (Article 2(27)ER).
130. CACM aims at reaching an optimal balance between short-term and long-term measures, whilst avoiding undue discrimination and avoiding that internal congestions are pushed to the border. The EU applicable regulatory framework avoids “undue” discrimination because all discrimination cannot be avoided in a zonal model. Hence the EU applicable legal framework allows, as regards CA, for an acceptable level of discrimination to be agreed upon in Core CCM (ACER Decision 02/2019).
131. Similarly, at cost sharing level, LFs, i.e. physical flows in one BZ caused by internal commercial transaction in another BZ, are unavoidable in a zonal model. Hence, the EU applicable legal framework allows, as regards CM, for an acceptable level of LFs to be agreed upon (the Contested Decision).
132. As set out above, the choice of CACM measures depends on the timing of this choice.
133. RAs are CM measures of last resort, as shown graphically below:

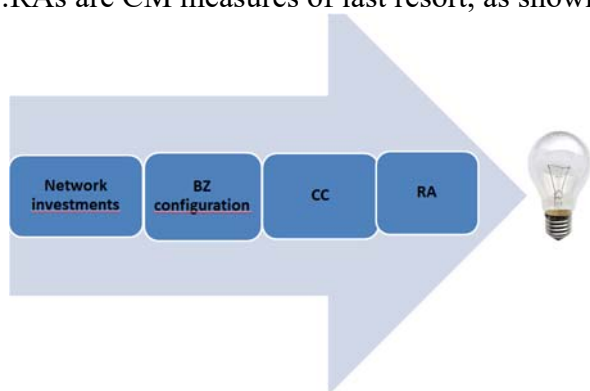

Source: Board of Appeal

134. Given this time sequence, RAs are an alternative for all other measures. However, the reverse is not true. In order to solve congestion close to delivery of electricity, network investments, BZ reconfigurations and CC cannot substitute RAs.

1.1.3 The need for coordination of RAs in Core CCR.

135. RAs can be coordinated or not coordinated.
136. The EU electricity regulatory framework requires a systematic coordination of potential RAs that are at least sometimes able to address violations of current limits on XNEs (“XRAs”). This coordination aims at replacing *ad hoc* bilateral or multilateral coordination by NRAs. Coordination of XRAs allows for the identification of the most effective and economically efficient XRAs to solve identified physical congestions and relieve OS violations, irrespective of whether the reasons for the physical congestion fall within or outside the TSOs’ control area.
137. The coordinated methodologies foreseen by the EU applicable regulatory framework identify the optimal CM measures, regardless of their cost.
138. The coordination of RAs is decided at EU level through the CSAM (ACER Decision 07/2019) and CGMM-v3 (a precondition for CCC and CROSA).
139. The CROSA is a process of OS analysis performed in accordance with Article 78 SO, which requires TSOs to involve Regional Security Coordinators (“RSCs”).

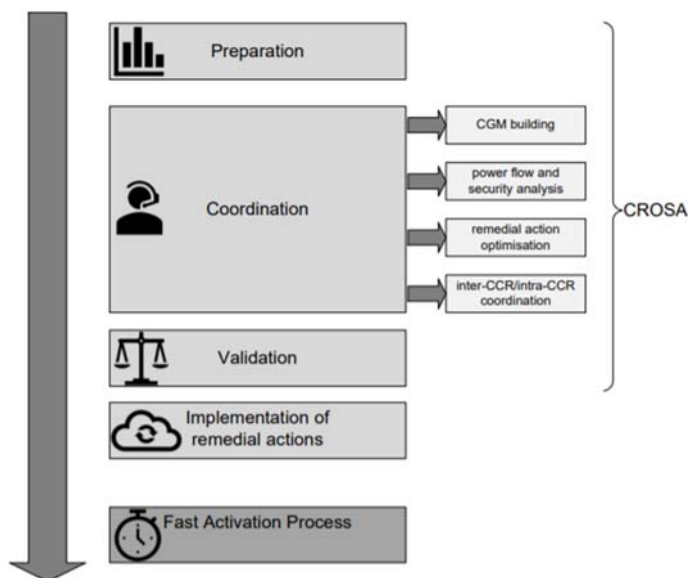
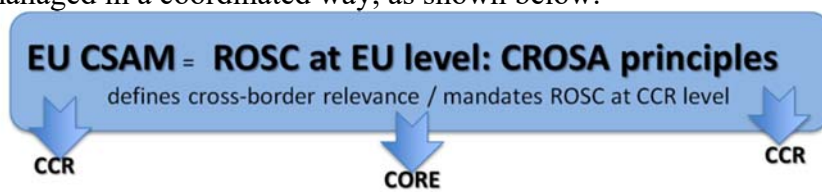

Figure 1: Overview Coordinated Regional Operational Security Assessment (CROSA)

process

Source: ENTSO-E Explanatory Document to the Core CCR ROSC in accordance with Article 76 SO³⁶.

140. At EU level, the CSAM requires an identification of NEs where OS violations need to be managed in a coordinated way, as shown below.



Source: Board of Appeal.

141. The EU applicable regulatory framework foresees coordinated methodologies to identify the optimal CM measures, regardless of their cost. A correct scope of the methodologies is therefore key, as it impacts *a priori* the choice of the most optimal CM measure and, hence, the essence of CM.
142. The need for coordination and harmonisation of RDCTCS processes in Core CCR has been set out in All Core TSOs' Report assessing the progressive coordination and harmonisation of mechanisms and agreements for RDCT in accordance with article 35(3) CACM³⁷. It states that, generally, the agreements and mechanisms used for RDCT “are national, and they are often quite different due to historical reasons.” “Except within the TSC cooperation covering a part of the CCR, there is currently **no** regional cost-sharing methodology (polluter-pays or socialisation of costs) in place. The cost-sharing agreements are highly dependent on the specific border/contract between TSOs. Most of the time, the “requester pays” principle is applied, meaning that the TSO with the congestion has to cover the costs of the remedial actions needed to relieve it. Some bilateral agreements exist between TSOs, in those cases, socialization of costs is applied for specific congestions.” (emphasis added).
143. Said report also states the following: “Coordinating the use of RAs at regional level to avoid unnecessary distortions and improve the global social welfare. An **improved coordination of RDCT measures** should be considered as an **essential step towards the optimization of the actions taken by TSOs to effectively relieve physical congestions, limit congestion management costs and maximize the cross-border capacity made available to the market**. This is especially the case for CORE region, as the application of the “20% minRAM rule” in the FB CCM recently approved within CWE, already extends the number of cases where RDCT measures are necessary. It is therefore regrettable that TSOs have considered this report as a mere formal exercise in order to strictly meet CACM deadline (26 months after CCRs approval) and did not take the opportunity to conduct an in-depth analysis of current practices to assess potential solutions to move towards a

³⁶ Annex 22 to the Defence.

³⁷ <https://eepublicdownloads.entsoe.eu/clean-documents/Network%20codes%20documents/Implementation/ccr/methodologies/core/cacm-deliverables/coordinated-rd-and-ct-art-35/20190117-core-tsos-consultation-report-harmonisation-final.pdf>

progressive coordination and harmonisation of current mechanisms and agreements for RDCT. One Market Party considers that the report should not only list the current practices already in place, but should also take this opportunity to assess the underlying reasons why TSOs have decided to rely on CT and/or RD and/or non-costly remedial actions only. It would highlight whether diverging TSOs practices are due to historical reasons, different network structures and/or market designs. Such an assessment would also provide good guidance for defining the adequate level of harmonization needed.” (emphasis added).

144. This need for coordination of XRAs in the Core CCR was also stressed in the responses to the public consultation leading-up to ACER Decision 35/2020 and 33/2020 respectively on the RDCT and ROSC³⁸.

1.1.4 Operational security in EU electricity regulation.

145. The Board of Appeal observes that the differentiation alleged by various Appellants, between material processes to ensure OS, governed by SO, on the one hand, and material processes enabling CB trade, governed by CACM, on the other hand, is incorrect.

146. It is not only the SO that relates to OS. The objectives of the CACM and the ER are the integration of the European electricity market through a harmonised framework for CB exchanges of electricity, whilst ensuring OS.

147. Recital (2) ER states: *“The Energy Union aims to provide final customers – household and business – with **safe, secure, sustainable, competitive and affordable energy.**” (emphasis added).*

148. Recital (20) and (21) ER states: *“(20) When regional coordination centres carry out a capacity calculation, they should maximise capacity considering non-costly remedial actions and respecting the operational security limits of transmission system operators in the Capacity Calculation Region. Where the calculation does not result in capacity equal to or above the minimum capacities set out in this Regulation, regional coordination centres should consider all available costly remedial actions to further increase capacity up to the minimum capacities, including redispatching potential within and between the capacity calculation regions, **while respecting the operational security limits** of transmission system operators of the Capacity Calculation Regions. Transmission system operators should report accurately and transparently on all aspects of capacity calculation in accordance with this Regulation and should ensure that all information sent to regional coordination centres is accurate and fit for purpose. (21) When performing capacity calculation, regional coordination centres should calculate cross-zonal capacities using data from transmission system operators **which respects the operational security limits** of the transmission system operators' respective control areas. Transmission system operators should be able to deviate from coordinated capacity calculation where its implementation would result in a **violation of the operational security limits of network elements** in their control area. Those deviations should be carefully monitored and transparently reported to prevent abuse and ensure that the volume of interconnection capacity to be made available to market participants is not limited in order to solve congestion inside a bidding zone. Where an action plan is in place, the action plan should take account of deviations and address their cause.” (emphasis added).*

149. Article 1(1) ER states that the ER aims to *“(a) set the basis for an efficient achievement of the objectives of the Energy Union and in particular the climate and energy framework for 2030 by enabling market signals to be delivered for increased efficiency, higher share of renewable energy sources, **security of supply**, flexibility, sustainability, decarbonisation and innovation”; and “(d) facilitate the emergence of a well-functioning and transparent wholesale market, contributing to **a high level of security of electricity supply**, and provide for mechanisms to harmonise the rules for cross-border exchanges in electricity”.* (emphasis added).

150. Recitals (1) and (2) CACM state *“(1) The urgent completion of a fully functioning and interconnected internal energy market is crucial to the **objectives of maintaining security of energy supply**, increasing competitiveness and ensuring that all consumers can purchase energy at affordable prices. A well-functioning internal market in electricity should provide producers with appropriate incentives for investing in new power generation, including in electricity from renewable energy sources, paying special attention to the most isolated Member States and regions in the Union's energy market. A well-functioning market should also provide consumers with adequate measures to promote more efficient use of energy, which presupposes a secure supply of energy. (2) **Security of energy supply** is an essential element of public security and is therefore inherently connected to the efficient functioning of the internal market in electricity and the integration of the isolated electricity markets of Member States. Electricity can reach the citizens of the Union only through the network. Functioning electricity markets and, in particular, the networks and other assets associated with electricity*

³⁸ Annex II to ACER Decision 35/2020 and Annex II to ACER Decision 33/2020;
https://acer.europa.eu/Official_documents/Acts_of_the_Agency/Individual%20decisions%20Annexes/ACER%20Decision%20No%2033-2020_Annexes/ACER%20Decision%2033-2020%20on%20Core%20ROSC%20-%20Annex%20II.pdf

supply are essential to public security, to economic competitiveness and to the well-being of the citizens of the Union.” (emphasis added)

151. Article 3 CACM states that the objectives of CACM cooperation include “(c) ensuring operational security”.
152. Turning to the provisions that apply to RDCT and RDCTCS, they are intrinsically linked to OS.
153. Article 35 CACM, which mandates the creation of the RDCT, stipulates in Article 35(4) CACM: “Each TSO shall abstain from unilateral or uncoordinated redispatching and countertrading measures of cross-border relevance. Each TSO shall coordinate the use of redispatching and countertrading resources taking into account their impact on operational security and economic efficiency.” (emphasis added)
154. Article 74 CACM, which mandates the creation of the RDCTCS requires in Article 74(5) CACM that the RDCTCS includes “(c) a mechanism to assess the impact of the remedial actions, based on operational security and economic criteria” (emphasis added).
155. The 74 CACM requires the RDCTCS to be consistent with the general CM principles of Article 16 ER. Article 16 ER, which sets out the general principles CA and CM, highlights the importance of OS in (i) Article 16(3) (“Regional coordination centres shall calculate cross-zonal capacities respecting operational security limits using data from transmission system operators including data on the technical availability of remedial actions, not including load shedding. Where regional coordination centres conclude that those available remedial actions in the capacity calculation region or between capacity calculation regions are not sufficient to reach the linear trajectory pursuant to Article 15(2) or the minimum capacities provided for in paragraph 8 of this Article while respecting operational security limits, they may, as a measure of last resort, set out coordinated actions reducing the cross-zonal capacities accordingly. Transmission system operators may deviate from coordinated actions in respect of coordinated capacity calculation and coordinated security analysis only in accordance with Article 42(2).”;(ii) Article 16(8) and (9) ((..) a) for borders using a coordinated net transmission capacity approach, the minimum capacity shall be 70 % of the transmission capacity respecting operational security limits after deduction of contingencies, as determined in accordance with the capacity allocation and congestion management guideline adopted on the basis of Article 18(5) of Regulation (EC) No 714/2009, (b) for borders using a flow-based approach, the minimum capacity shall be a margin set in the capacity calculation process as available for flows induced by cross-zonal exchange. The margin shall be 70 % of the capacity respecting operational security limits of internal and cross-zonal critical network elements, taking into account contingencies, as determined in accordance with the capacity allocation and congestion management guideline adopted on the basis of Article 18(5) of Regulation (EC) No 714/2009. 9. At the request of the transmission system operators in a capacity calculation region, the relevant regulatory authorities may grant a derogation from paragraph 8 on foreseeable grounds where necessary for maintaining operational security. Such derogations, which shall not relate to the curtailment of capacities already allocated pursuant to paragraph 2, shall be granted for no more than one-year at a time, or, provided that the extent of the derogation decreases significantly after the first year, up to a maximum of two years. The extent of such derogations shall be strictly limited to what is necessary to maintain operational security and they shall avoid discrimination between internal and cross-zonal exchanges.”) and (iii) Article 16(11) “As far as technically possible, transmission system operators shall net the capacity requirements of any power flows in opposite directions over the congested interconnection line in order to use that line to its maximum capacity. Having full regard to network security, transactions that relieve the congestion shall not be refused.” (emphasis added).

1.1.5 EU electricity regulation links the RDCTCS, RDCT and ROSC methodologies.

156. The applicable regulatory framework, to be found in the CACM and SO, links all 3 Core methodologies, whilst referring at the same time to the EU CSAM:

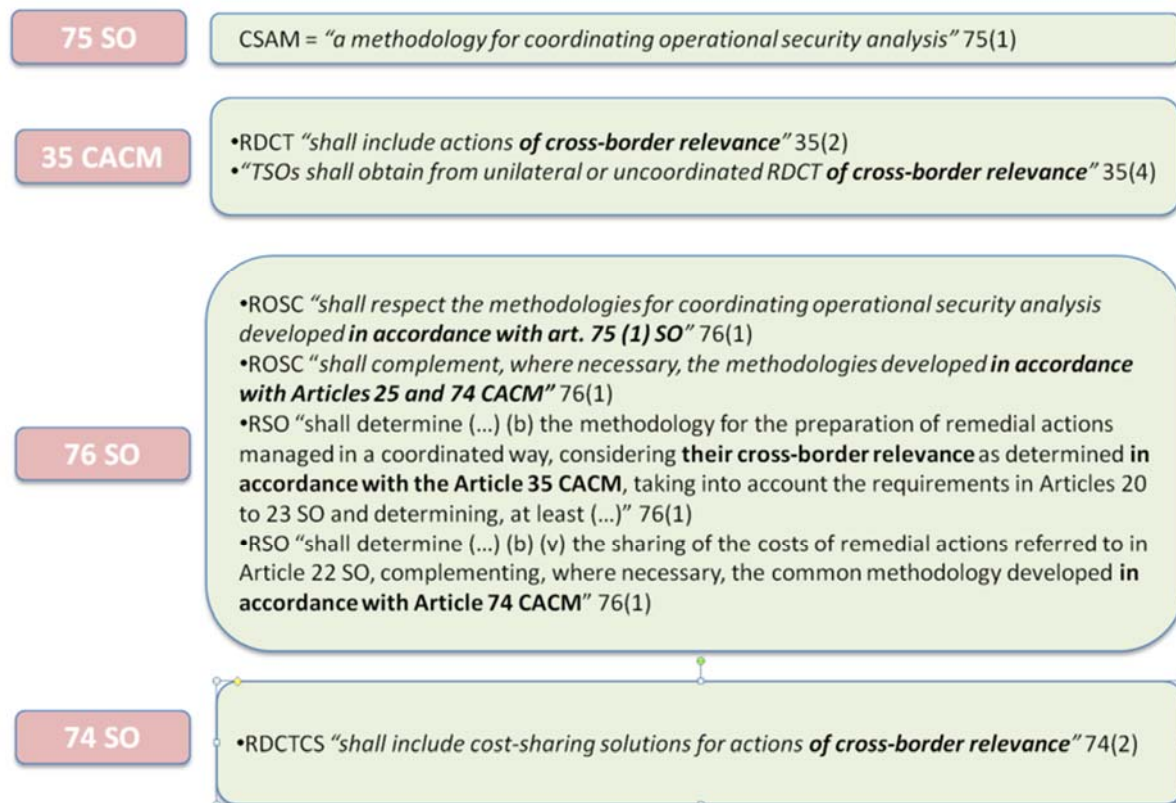

Source: Board of Appeal

157. All Core NRAs have expressly recognised this link in their Non-Paper on All TSOs' ROSC: "Core NRAs agree that the ROSC proposal and the RDCT methodologies are interlinked and describe complementary processes. For instance, the methodology following Article 35 of the CACM Regulation and the ROSC methodology both describe the coordination of redispatching and countertrading. Network elements which are eligible for cost sharing according to Article 74 of the CACM Regulation must also be defined within the ROSC methodology. Core NRAs acknowledge the utmost importance of harmonization and consistency between these methodologies. It was therefore agreed, that such consistency would be best addressed in case the methodologies were dealt with together"³⁹.

1.1.6 All 3 methodologies have duly been linked.

158. At EU level, the CSAM requires an identification of NEs where OS violations need to be managed in a coordinated way. The interaction between the methodologies at EU level and the methodologies at Core level is depicted as follows:

³⁹ <https://www.acer.europa.eu/en/Electricity/OPERATION-CODES/SYSTEM-OPERATION/Documents/Core%20Non-Paper%20on%20ROSC.pdf>

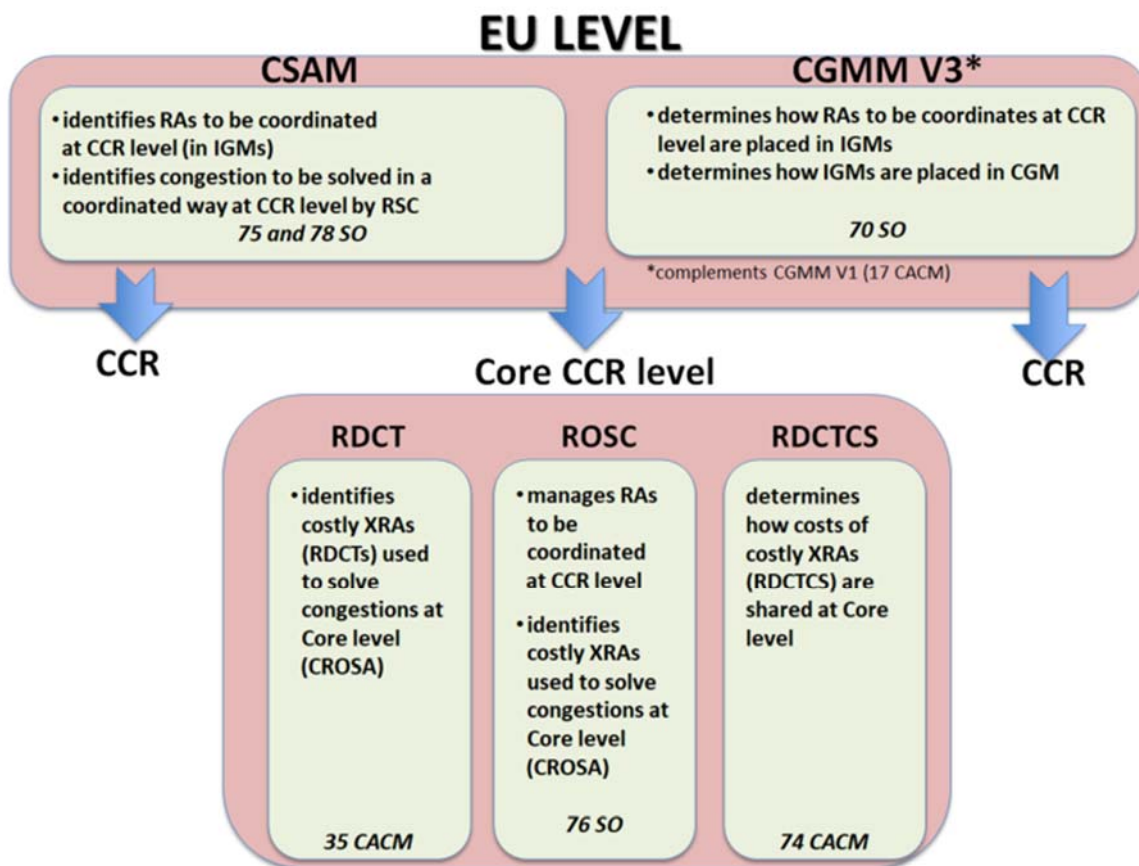

Source: Board of Appeal.

159. The applicable regulatory framework provides for cross-references between the methodologies at EU level and CCR level, which need to comply with the general CM principles of Article 16 ER, as depicted below:

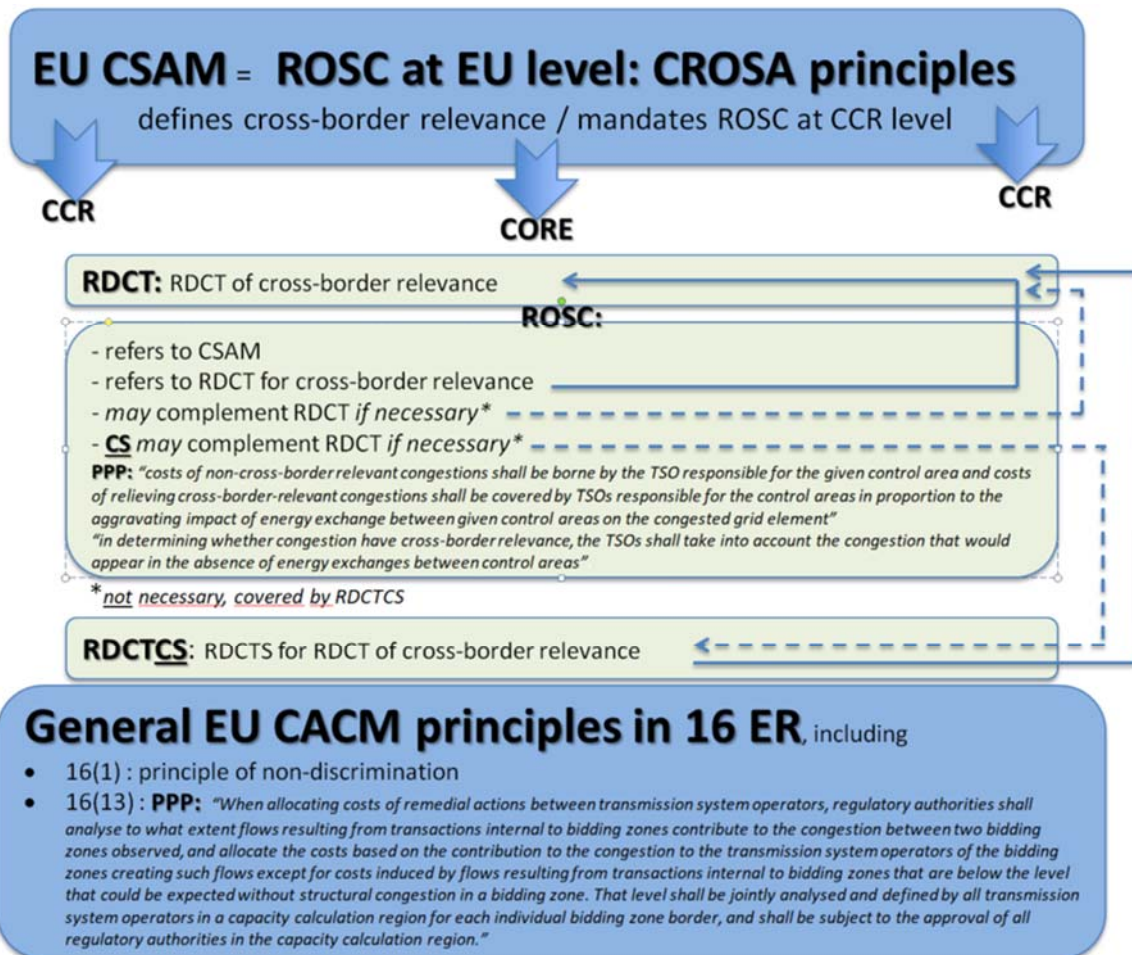

Source: Board of Appeal.

160. Article 15 CSAM states that CROSA applies to "CB relevant NEs" or XNEs.

161. It defines these XNEs as "CNEs and other NEs above a voltage level defined by TSOs, except for those elements for which all TSOs in a CCR agree that they are not cross-border relevant for the concerned CCR and may therefore be excluded". As set out in paragraph 70 of ACER Decision 07/2019 on the CSAM, some NEs that are not CNEs may still be XNEs, for example when they are significantly impacted by LF's from neighbouring BZs. It states: "To address this problem, the Agency is of the opinion that the notion of cross-border relevance should include all network elements where the percentage of flows resulting from exchanges outside the TSO control area where such network element is located is significant. As such, this principle requires deeper analyses by TSOs in a CCR. Therefore, the Agency replaced the proposed principle (i.e. at least critical network elements) with a more comprehensive high level principle to harmonise the identification of cross-border relevant network elements across CCRs. The latter should result in the cross-border relevant network elements to comprise all network elements above certain voltage level except those network elements for which all TSOs in a CCR agree that they are not cross-border relevant. The Agency also understands that including too many network elements in the coordination does not risk a loss of economic efficiency or operational security in regional coordination. However, including not enough network elements would indeed entail such risk. For this reason, the principle for the identification of cross-border relevant network elements as proposed by the Agency is considered as adequate." (emphasis added).

162. The test of the CSAM is cross-border relevance. Cross-border relevance of NEs involves the mutual interdependency of such NEs and RAs by laws of physics.

163. The CSAM applies since 2020. Once the CSAM has decided at EU level which RAs have to be coordinated, the CACM mandates a bottom-up decision-making process for the RDCT, ROSC and RDCTCS at Core CCR level. These processes were finalised by ACER Decisions 35/2020 (RDCT), 33/2020 (ROSC) and the Contested Decision.

164. Consequently, at Core level, both the ROSC and the RDCT had to apply the CROSA to XNEs as defined by CSAM, i.e. (i) CNEs and (ii) NEs over a voltage level to be determined

by All Core TSOs. All Core TSOs determined said voltage level at 220 kV. The scope implies that XNEs can be CB NEs or internal NEs, as long as they are CB relevant.

165. Under the CROSA process, the optimised and coordinated RDCT actions aim to relieve physical congestion on all XNEs (i.e. CNEs and NEs \geq 220 kV), irrespective of whether the reasons for the physical congestion fall inside or outside the TSOs' control area.
166. One of the purposes of managing OS violations on a set of NEs in a co-ordinated way is to ensure that full account is taken of the consequences of RAs on one NE for other interacting NEs. Failure to do so may impact OS. As stated in Recital (12) ROSC, the Core CCR is characterised by a highly meshed network, and at 220kV or above, it is not possible to identify a NE that would be impacted only by remedial actions that do not have any impact on other elements. Also, RAs are, as set out above in Sub-Plea 1.1.2, CM measures of last resort. Hence, a restrictive approach as to the NEs to include in its scope would imply that there would remain no alternative solution to solve congestions on the excluded NEs, threatening OS.
167. As expressly set out in paragraph 133 of ACER Decision 33/2020 (ROSC), the threshold of \geq 220 kV was set in accordance with the PPP articulated in Article 76 SO, taking into account the structural congestion that would appear in the absence of energy exchanges. This threshold implies that, in the absence of energy exchanges, NEs \geq 220 kV would not be congested and are thus XNEs. When setting the limit of 220 KV, ACER duly reproduced Article 5(1) of All Core TSOs' ROSC Proposal, in which All Core TSOs stated that "network elements in the Core CCR with a voltage level higher or equal to 220 kV" would be "subject to CROSA, on which operational security limits violations need to be managed in a coordinated way"⁴⁰.

168. The Explanatory Document to All Core TSOs' ROSC Proposal clearly delineates the scope for XNEs as follows⁴¹:

*"The following figure 2 shows **which elements (highlighted in yellow)** can be discarded from the set of secured elements in accordance with the provisions explained above:*

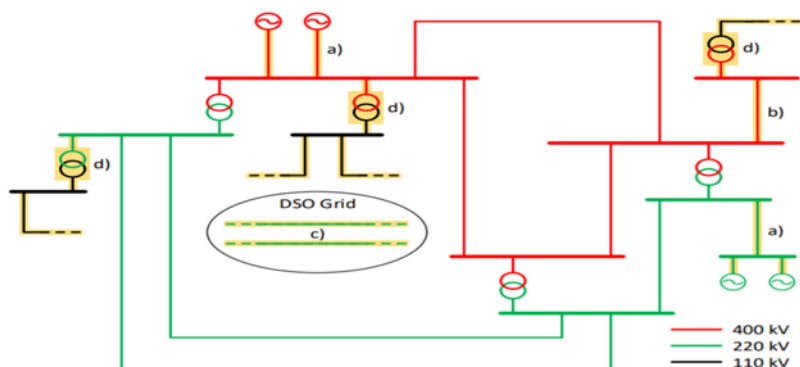

Figure 2: Elements (highlighted in yellow) which can be discarded from the set of Core XNEs

In addition to these criteria, any element can be discarded from the set of secured elements, when a common agreement among Core TSOs is reached. This could be the case, if a part of the grid is almost not influenced trans-regionally. However, such a rule cannot be applied to the Critical Network Elements in accordance with Article 5 of day-ahead and intraday capacity calculation methodology of the Core CCR and XBRNEs in accordance with the Core RD and CT methodology."

Source: Explanatory Document to All Core TSOs' ROSC Proposal (emphasis added).

169. Hence, the scope of the ROSC and RDCT of CNEs and NEs \geq 220 kV has correctly been set in accordance with CSAM. Both the RDCT and ROSC have an identical scope because they both apply CROSA. Under the CROSA process, the optimised and coordinated RDCT actions aim to relieve physical congestion on all XNEs, irrespective of whether the reasons for the physical congestion falls inside or outside TSOs' control area (i.e. CNEs and NEs \geq 220 kV).
170. The Explanatory Document to All Core TSOs' ROSC Proposal clearly explained that the scope of XNEs would be wider than CNEs and graphically depicted as follows⁴²:

⁴⁰https://eepublicdownloads.entsoe.eu/clean-documents/nc-tasks/EBGL/SO_GL_A76_CORE_CCR_ROSC%20Methodology.pdf

⁴¹ Annex 22 to the Defence, p. 9.

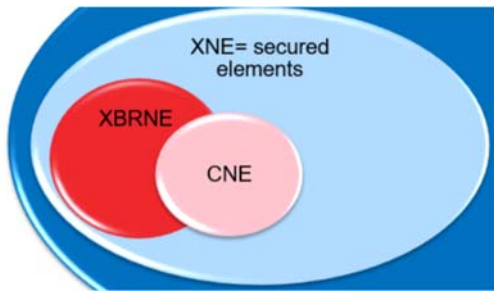

Source: Explanatory Document to All Core TSOs' ROSC Proposal.

171. ACER correctly determined that the scope of the RDCTCS had to match the scope of the ROSC and RDCT. The RDCT and ROSC need a cost sharing mechanism in order to be implemented because of their very nature: when optimising RA coordination, RDCT and ROSC aim at minimising costs deriving from RAs. Regional RA coordination can only occur if an adequate cost sharing ensues and, *vice versa*, cost sharing of RAs can only occur once the RAs have taken place. This is duly illustrated by ACER in paragraph 167 of ACER Decision 33/2020 (ROSC): “For example, a congestion on the border between Germany and Poland may be most efficiently resolved by involving downward redispatching of generating unit(s) in Germany and upward redispatching of generating unit(s) in Czech Republic. It is expected that this redispatching actions will involve some revenues for German TSOs and some costs for the Czech TSO. Naturally, the Czech TSO will only be willing to support solving the congestion on the border between Germany and Poland if the incurred costs will be shared with all involved TSOs based on the polluter-pays principle. It is thus impossible to expect that TSOs can fully coordinate remedial actions at regional level without having the certainty that the corresponding costs will be shared among all TSOs.”
172. The Board of Appeal finds that the scope of the ROSC, RDCT and RDCTCS has correctly been defined by ACER Decision 33/2020, ACER Decision 35/2020 and the Contested Decision.

1.1.7 The RDCTCS is in line with the CACM, the ER and the PPP.

173. As set out above, the RDCTCS scope has correctly been set as including XNEs in accordance with the ROSC and RDCT at Core level and CSAM at EU level.
174. The Board of Appeal finds that removing internal XNEs or another subset of XNEs would lead the RDCTCS to infringe Article 74(2) CACM, which requires that the RDCTCS applies to XNEs, including both CB XNEs and internal XNEs, to the extent that they are CB relevant (i.e. CNEs or NEs ≥ 220 kV).
175. Indeed, the removal of a subset of XNEs from the scope of the RDCTCS - beyond the exceptions foreseen by the scope of the RDCTCS, i.e. the exceptions foreseen for (i) NEs < 220 kV; (ii) NEs that are not CNEs and are radial lines, distribution NEs, transformers with secondary voltage < 220 kV or commonly agreed upon by All Core TSOs and (iii) XNEs that are part of another CCR CROSA, for TSOs belonging to more than one CCR - would lead to non-compliance with the requirements of Article 74 CACM, which is the legal basis on which the RDCTCS is adopted.
176. A removal of a subset of XNEs from the scope of the RDCTCS would not only infringe Article 74(2) CACM, but also annihilate the very concept of cost-sharing pursuant to RA coordination. Sharing a cake after having severed part of it does not amount to sharing.
177. It would, furthermore, not only undermine cost sharing under the RDCTCS, but also undermine a correct functioning of the ROSC and RDCT and even negatively affect efficient CACM all in all in the Core CCR. It would negatively affect RA coordination in Core CCR because, as already set out above, regional RA coordination can only occur if an adequate cost

⁴² Annex 22 to the Defence, p. 10. All Core TSOs' ROSC Proposal differentiated between secured NEs and scanned NEs. Secured NEs correspond with XNEs. Scanned NEs are NEs monitored during CROSA such that CROSA does not worsen, or create new OS violations (see Article 2(s) of the Contested Decision's ROSC.

sharing is put in place. It would counter the CSAM and disrupt the CROSA process at CORE level, set about above in Sub-pleas 1.1.5 and 1.1.6.

178. Put in a broader context, it would negatively affect an efficient CACM in Core CCR because according to the CCM (ACER Decision 02/2019), Core TSOs are under an obligation to continuously monitor and identify the most efficient CM method for congestions on internal XNEs, e.g. CC, RAs, BZ reconfiguration or network investments (see Sub-plea 1.1.2 above) and their decision to address congestions with RAs depends on the coordination of RAs and related cost-sharing. In the absence of cost sharing for specific congested XNEs, RAs could no longer be considered as an alternative CM method for those XNEs. This would automatically prevent efficient CM as required by Article 16(1) ER. CCM and CROSA need to be fully integrated as both are measure foreseen by CACM. Through the identification of the most effective CM measures, CACM aims at maximising CZC and ensuring OS.
179. Not applying the RDCTCS to all XNEs would infringe Article 74(2) CACM, which expressly requires the RDCTCS to provide cost sharing solutions for actions “*of cross-border relevance*”, i.e. CNEs or NEs ≥ 220 kV (in line with CSAM, RDCT and ROSC as set out above in Sub-pleas 1.1.5 and 1.1.6). Indeed, cross-border relevance of NEs involves the mutual interdependency of such NEs and RAs by laws of physics. If XNEs are excluded, the excluded XNEs would, therefore, still be impacted by RA activation on included XNEs, with likely negative OS consequences. The erroneous exclusion of XNEs from the CROSA scope would have as a consequence that physical congestion would not be relieved on the excluded XNEs and would threaten OS on those XNEs.
180. Under the CROSA process, the optimised and coordinated RAs aim to relieve physical congestion on all XNEs (i.e. CNEs and NEs ≥ 220 kV), irrespective of whether the reasons for the physical congestion fall inside or outside the TSOs’ control area. For example, an exclusion of internal XNEs would infringe Article 74(2) CACM because internal XNEs owned by a TSO could be congested by (i) LFs from neighbouring BZs, not caused CB trade or (ii) RAs taken in BZs of other TSOs. Such internal XNEs should therefore be eligible for cost sharing.
181. As set out above in Sub-plea 1.1.2, impeding the inclusion of some NEs in costly RAs whilst overly extending CC to NEs may affect the optimal CM choice (a choice could be made for CC even it would not prove to be the economically most efficient means to address congestion). RAs are CM measures of last resort, close to real time. Hence, a restrictive approach as to the XNEs to include in its scope would imply that there would remain no alternative solution to solve congestions on the excluded XNEs, threatening OS. Moreover, the exclusion of XNEs from RAO would not only maintain but even worsen OS issues in relation to these NEs. Given that these NEs have cross-border relevance, they are impacted by RAs activated to solve violations on included XNEs. Wrongfully excluding such XNEs from the scope would not be able to eliminate their intrinsic cross-border nature.
182. Excluding some XNEs from the scope of the RDCTCS would also introduce a serious element of discrimination. This would be contrary to Article 74(6)(i) CACM, which requires the RDCTCS to “*(i) comply with the principles of transparency and non-discrimination.*”, Article 3(e) CACM containing the CACM objective of “*ensuring fair and non-discriminatory treatment of TSOs, NEMOs, the Agency, regulatory authorities and market participants*” and the general principle of CA and CM of Article 16(1) ER, which states that “*Network congestion problems shall be addressed with non-discriminatory market-based solutions which give efficient economic signals to the market participants and transmission system operators involved. Network congestion problems shall be solved by means of non-transaction-based methods, namely methods that do not involve a selection between the contracts of individual market participants. When taking operational measures to ensure that its transmission system remains in the normal state, the transmission system operator shall take into account the effect of those measures on neighbouring control areas and coordinate such measures with other affected transmission system operators as provided for in Regulation (EU) 2015/1222.*”
183. According to ACER, as per its Rejoinder and statements at the Oral Hearing, the infringement of the principle of non-discrimination is key in determining the correct RDCTCS scope.

Intervenors II to VI support this stance. They allege that the exclusion of a subset of XNEs from the RDCTCS although these XNEs are included in the ROSC (optimisation through CROSA) would lead to an unjustified discrimination⁴³. Disregarding LFs on some XNEs would be similar to determining an infinite legitimate LF threshold on those XNEs, applying a full OPP to these XNEs and carrying out a hidden transfer of costs from TSOs in BZs generating LFs towards TSOs in BZs hosting LFs that own the excluded XNEs.

184. As a consequence, applying the RDCTCS only to a part of its scope would also infringe Article 74(6)(f) CACM, which requires that it should “*facilitate adherence to the general principles of congestion management as set out in Article 16 of Regulation (EC) No. 714/2009*” because these general principles also include Article 16(1) ER. As correctly pointed out by Appellant V in its Reply⁴⁴, the entire Article 16 ER has to be understood in view of the principle of non-discrimination stated in its paragraph 1. According to settled case-law, any EU provision needs to be interpreted in compliance with the principle of non-discrimination⁴⁵.
185. The removal of a subset of XNEs from the scope of the RDCTCS would also be contrary to Article 74(6)(b) CACM, which requires the RDCTCS to “*(b) be consistent with the responsibilities and liabilities of the TSOs involved*” because All Core TSOs would be infringing their obligations under Article 74 CACM and 16 ER when failing to apply a cost sharing solution to all XNEs.
186. In the same line, the removal of a subset of XNEs from the scope of the RDCTCS would be contrary to Article 74(6)(c) CACM, which requires the RDCTCS to “*(c) ensure a fair distribution of costs and benefits between the TSOs involved*”. It suffices to indicate that, due to the discriminatory treatment between TSOs that own internal XNEs and TSOs that own CB XNEs or interconnectors (assuming that this is the distinction meant by “*congestions between two bidding zones observed*”), the cost sharing solution provided by the RDCTCS would not be fair if not applied to its full scope of XNEs.
187. Removing a subset of XNEs from the scope of the RDCTCS would imply that, on the one hand, LF-causing TSOs would not have to pay the costs although they did not sufficiently invest in their electricity network or did not change their BZ configuration in order to reduce LFs that pollute internal XNEs owned by LF-hosting TSOs whereas, on the other hand, LF-hosting TSOs would have to bear those costs.
188. Moreover, if the RDCTCS were only to be applied to interconnectors, this would lead to the unfair situation that a TSO facing congestion on a BZB due to LFs would be entitled to cost sharing whereas a TSO facing congestion on other XNEs, not on a BZB, would not be entitled to cost sharing.
189. Not applying the RDCTCS to some XNEs would also be contrary to Article 74(6)(a) CACM, which requires the RDCTCS to “*provide incentives to manage congestion, including remedial actions and incentives to invest effectively*”. It would not provide the correct incentives to Core TSOs. LF-causing TSOs would not receive the correct incentives to take the necessary measure to reduce their LFs below the legitimate LF threshold, e.g. through investments in network upgrades. Furthermore, as set out by ACER in its Defence, solving LFs on LF-causing XNEs is a prerequisite for LF-causing TSOs in order to solve problems of IFs causing internal congestion.
190. Finally, narrowing the scope of the RDCTCS would infringe Article 74(6)(e) CACM, which requires the RDCTCS to “*(e) facilitate the efficient long-term development and operation of the pan-European interconnected system and the efficient operation of the pan-European electricity market*”. As set out above, it would not only obliterate cost sharing under the RDCTCS, but also undermine a correct functioning of the ROSC and RDCT and negatively affect efficient overall CACM in the Core CCR.

⁴³ Application for Interventions by Intervenors II, III, IV, V and VI.

⁴⁴ Reply of Appellant V, para 247.

⁴⁵ Cases C-402/07 and C-432/07, *Sturgeon v Condor*, ECLI:EU:C:2009:716, para 48.

191. The Board of Appeal finds that the scope of the RDCTCS neither infringes Article 16(13) ER nor the PPP.
192. Article 74(6)(f) CACM requires the RDCTCS to “facilitate adherence to the general principles of congestion management as set out in Article 16 of Regulation (EC) No 714/2009.”
193. Regulation (EC) 714/2009 is the Old ER. Point 1.7 of Annex 1 to the Old ER contained CM principles: “When defining appropriate network areas in and between which congestion management is to apply, TSOs shall be guided by the principles of cost-effectiveness and minimisation of negative impacts on the internal market in electricity. Specifically, TSOs shall not limit interconnection capacity in order to solve congestion inside their own control area, save for the abovementioned reasons and reasons of operational security. If such a situation occurs, this shall be described and transparently presented by the TSOs to all the system users. Such a situation shall be tolerated only until a long-term solution is found. The methodology and projects for achieving the long-term solution shall be described and transparently presented by the TSOs to all the system users.”
194. ACER’s Recommendation 02/2016 on the common capacity calculation and redispatching and countertrading cost sharing methodologies (“**ACER Recommendation 02/2016**”) set out principles, including the PPP. ACER Recommendation 02/2016⁴⁶ stipulated: “the costs of remedial actions are most often paid by the TSOs facing congestion problems (i.e. requester-pays principle) rather than the ones causing them (i.e. polluter-pays principle)”.
195. Recast ER (“**ER**”) has been adopted in the context of the Clean Energy Package, which introduces stricter and harmonised rules for capacity mechanisms (reconciling EU objectives of security of supply and emission reductions), enhances regional coordination in order to improve market functioning and competitiveness and fosters the completion of the internal electricity market. Since ER, Article 74(6)(f) CACM has to be understood as facilitating adherence to the general principles of CM of the ER instead of the Old ER (see Article 70 ER: “Regulation (EC) No 714/2009 is repealed. References to the repealed Regulation shall be construed as references to this Regulation and shall be read in accordance with the correlation table set out in Annex III”).
196. Article 16(13) ER provides: “When allocating costs of remedial actions between transmission system operators, regulatory authorities shall analyse to what extent flows resulting from transactions internal to bidding zones contribute to the congestion between two bidding zones observed, and allocate the costs based on the contribution to the congestion to the transmission system operators of the bidding zones creating such flows except for costs induced by flows resulting from transactions internal to bidding zones that are below the level that could be expected without structural congestion in a bidding zone. That level shall be jointly analysed and defined by all transmission system operators in a capacity calculation region for each individual bidding zone border, and shall be subject to the approval of all regulatory authorities in the capacity calculation region.”
197. Article 16(13) ER reflects the PPP: it mandates regulatory authorities to identify the cause of the congestions and and mandates TSOs, upon regulatory supervision, to determine a threshold in order to allocate costs to TSOs that are causing polluting flows above the threshold.
198. According to Article 16(13) ER, the origins of physical flows that are contributing to the congestions on XNEs need to be identified.
199. Accordingly, the Contested Decision’s RDCTCS first maps XRA costs to XNECs (Article 5 of the Contested Decision’s RDCTCS) and then distributes the costs on XNECs to Core TSOs (Article 7 of the Contested Decision’s RDCTCS).
200. Article 16(13) ER requires that the physical flows resulting from electricity exchanges or transactions internal to BZs - i.e. IFs and LFs - should be identified as contributors to the congestion. It further requires that, when allocating costs, the ensuing cost sharing methodology allocates them to TSOs of the BZs causing such flow, based on the contribution to the congestion to TSOs of BZs. In case of CZ XNEs, these flows are LFs, whereas in case of internal NEs, these flows are IFs and LFs (IFs caused by electricity exchanges within the BZ where the NE is located and LFs caused by electricity exchanges within other BZs). As will be set out below in the Sixth Consolidated Plea, LFs should be identified as the primary contributors to the congestion on internal XNEs, whereas IFs should be penalised only for the remaining volume of the congestion.

⁴⁶ http://www.acer.europa.eu/Official_documents/Acts_of_the_Agency/Recommendations/ACER%20Recommendation%2002-2016.pdf

201. Accordingly, the Contested Decision's RDCTCS correctly decomposes the different types of flows on each XNEC in order to identify IFs and LFs (Article 6 of the Contested Decision's RDCTCS) and sets a *de minimis* threshold for LFs and not for IFs (Article 7(3) and (4) of the Contested Decision's RDCTCS). The OPP applies to IFs and LFs below the threshold, whereas the PPP applies to LFs above the threshold. The legitimate LF threshold is a temporary legitimate LF threshold which will automatically be replaced by a definitive legitimate LF threshold as soon as All Core TSOs agree upon such threshold and upon approval of All Core NRAs (see, Seventh Consolidated Plea). Furthermore, LFs above the threshold are prioritised in the prioritisation of flows when distributing costs. Article 7(6) of the Contested Decision's RDCTCS states that costs of LFs above the threshold come first in the prioritisation and will be attributed to the TSO causing the LF (Article 7(6)(a) of the Contested Decision's RDCTCS). Costs of IFs come second in the prioritisation and will be attributed to the TSOs XNE connecting TSO (Article 7(6)(b) of the Contested Decision's RDCTCS). The rest of the flows will come third and also be attributed to the XNE connecting TSO (Article 7(c) of the Contested Decision's RDCTCS).
202. Some Appellants argue that the textual wording of Article 16(13) ER, which requires that the PPP applies when costs are shared in relation to "*congestions between two bidding zones observed*", requires the RDCTCS to apply the PPP only to congestions "*between two bidding zones observed*". These Appellants claim that congestions "*between two bidding zones observed*" correspond with congestions on CB XNEs and that, consequently, the OPP applies to congestions on internal XNEs.
203. First, the textual wording of Article 16(13) ER does not limit the application of the PPP exclusively to congestions between 2 BZs. It does not impede the application of the PPP to other congestions than congestions between 2 BZs. It simply requires the application of the PPP to congestions between 2 BZs. A literal interpretation of Article 16(13) ER specifies the elements of a cost sharing solution for congestions between 2 BZs observed but it does not contain any prohibition regarding the adoption of a other cost sharing solutions.
204. Second, the application of the PPP to the full scope of the RDCTCS is confirmed by a contextual, teleological and historic interpretation, which requires the RDCTCS to apply the PPP to the full scope of XNEs⁴⁷.
205. It is not conceivable that a general CACM principle, which merely states that the PPP should apply to cost sharing in relation to some types of congestion, would imply that polluting flows on CB XNEs or interconnectors (i.e. XNEs located on a BZB) would contribute to costs pursuant to the PPP, whereas polluting flows of the same type on internal XNEs would not contribute to costs pursuant to the PPP (assuming that this is the distinction meant by "*congestions between two bidding zones observed*").
206. This would affect the RDCTCS scope in such a way that it would obliterate the entire package of CROSA-related methodologies in the Core region and, even worse, undermine efficient CM in Core CCR.
207. Analysing the provision's legal context in a systematic manner, the removal of a subset of XNEs from the scope of the RDCTCS would be contrary to most requirements of Article 74 CACM, as set out above. That is why All Core TSOs' RDCTCS Proposal duly linked the

⁴⁷ H.G. Schermes, D.F. Waelbroeck, "*Judicial Protection in the European Union*" (2001); N. Fennelly, "*Legal Interpretation at the European Court of Justice*", Fordham International Law Journal Volume 20, Issue 3 1996; A. Albers Llorens, "*The European Court of Justice, More than a Teleological Court*", Cambridge University Press, 2017;; Case 26/62 *Van Gend en Loos* ECLI:EU:C:1963:1; Case 6/64 *Costa v. ENEL* ECLI:EU:C:1964:66; Case 26/69 *Stauder v Ulm*, ECLI:EU:C:1969:57; Case 55/87 *Moksel v. BALM*, ECLI:EU:C:1988:377; Case C-89/81 *Hong Kong Trade*, ECLI:EU:C:1982:121; Case C-101/01 *Lindqvist* ECLI:EU:C:2003:596; Case C-409/06 *Winner Wette* ECLI:EU:C:2010:503; Case C-402/07 *Sturgeon and Others*, ECLI:EU:C:2009:716; Case C-439/08 *VEBIC* ECLI:EU:C:2010:739; Case C-41/09 *European Commission and Kingdom of the Netherlands*, ECLI:EU:C:2011:108; Joined Cases C-188/10 and C-189/10 *Melki and Abdeli* ECLI:EU:C:2010:363; Case C-583/11 *P Inuit Tapiriit Kanatami and Others*, ECLI:EU:C:2013:625.

RDCTCS scope to OS (see above, Sub-Plea 1.1.1). Recital (35) ER reinforces the correct interpretation of Article 16(13) ER whereby TSOs causing polluting flows need to bear the costs, as opposed to TSOs hosting polluting flows. It states that TSOs have to be compensated for costs deriving from hosting CB flows on their NEs by the TSOs causing these flows: “*In an open, competitive market, transmission system operators should be compensated for costs incurred as a result of hosting cross-border flows of electricity on their networks by the operators of the transmission systems from which cross-border flows originate and the systems where those flows end.*”.

208. Analysing the provision from a teleological angle⁴⁸, not defining the scope of the RDCTCS correctly as applying to all XNEs would go against the objectives of the CACM and the ER,. These goals are to maximise CZC and ensure OS through the identification of the most effective XRAs. As set out above, the removal of a sub-set of XNEs from the RDCTCS scope would undermine both regional coordination and efficient CM and could threaten OS in Core CCR.
209. Analysing the provision from a historical angle, ACER Recommendation 02/2016 set out principles, including the PPP, as correctly stated by Appellant VI in its appeal. These principles were subsequently included in Point 1.7 of Annex I to the Old ER and have now been developed into a binding set of detailed provisions in Articles 15 and 16 of the ER. The fact that ACER Recommendation 02/2016 complained about the fact that TSOs hosting congestions instead of TSOs causing congestions pay the costs: “*the costs of remedial actions are most often paid by the TSOs facing congestion problems (i.e. requester-pays principle) rather than the ones causing them (i.e. polluter-pays principle)*”⁴⁹ reinforces the correct interpretation of Article 16(13) ER. In this respect, the Board of Appeal dismisses the historical interpretation of Appellant IV’s Reply, based on unpublished working papers reflecting the unilateral interpretation of the German Delegation during the negotiation process in the Council of the draft ER⁵⁰, given that they do not constitute published “*travaux préparatoires*” capable of providing a binding interpretation of the final and agreed intention of the EU legislator, i.e. the Council and the Parliament⁵¹. The unilateral stance of Germany on the adopted provision of Article 16(13) ER does not imply that Council Members shared this stance when adopting the provision, especially regarding a legislative process that included a large number of national stances, triggered extensive debates and resulted in a compromise⁵². The Board of Appeal notes, in particular, that the differences between the text under discussion on 23 November 2018 and the text in Annex 4 of Appellant IV’s Reply dated 28 November 2018 does not reflect the proposal under discussion at that time⁵³.
210. As will be set out in the Fourteenth Consolidated Plea, ACER did not exceed its competence when determining the RDCTCS scope and did not amend the scope of Article 16(13) ER or Article 74 CACM.
211. Finally, some Appellants claim that the RDCTCS scope infringes the PPP articulated in Article 76 SO. However, the PPP articulated in Article 76 SO, depicted above in the graph of Sub-Plea 1.1.6, is in accordance with the general PPP.
212. The PPP of Article 76 SO states: “*1. Costs of non-cross-border relevant congestions shall be borne by the TSO responsible for the given control area and costs of relieving cross-border-relevant congestions shall be covered by TSOs responsible for the control areas in proportion to the aggravating impact of energy exchange*

⁴⁸ Board of Appeal Decisions A-004-2019 paras 106 and 158; A-001-2020, para 112 and A-002-2020, para 112.

⁴⁹ http://www.acer.europa.eu/Official_documents/Acts_of_the_Agency/Recommendations/ACER%20Recommendation%2002-2016.pdf

⁵⁰ Reply of Appellant IV, para 11 and Annexes 3 and 4 to Appellant IV’s Reply.

⁵¹ Cases C-295/95, Jackie Farrell v James Long, EU:C:1997:168, para 24; C-420/07, Apostolides, EU:C:2009:271, para 66; C-375/98, Epsom Europe BV, EU:C:2000:302, para 26; Opinion AG Kokott in C-583/11P, Inuit/Parliament and Council, EU:C:2013:21, para 32; Opinion AG Warner in Case 28/76 Milac, EU:C:1976:144, p. 164; Opinion AG Mayras in Case C-2/74, Reyners, EU:C:1974:68, p. 666.

⁵² Annexes 97 and 98 to the Rejoinder.

⁵³ Moreover, the German delegation’s proposals to include in draft Article 16(13) ER that “*costs for congestion within bidding zones shall be borne by the transmission system operators with the congestion*” was not adopted by the EU legislator.

between given control areas on the congested grid element. 2. In determining whether congestion have cross-border relevance, the TSOs shall take into account the congestion that would appear in the absence of energy exchanges between control areas”.

213. Article 76(1) SO states that costs of non-CB relevant congestions shall be borne by the TSO responsible for the given control area. The Contested Decision’s RDCTCS complies with this: cost sharing under the RDCTCS does not apply to non-XNEs. Article 76(1) SO further states that costs of relieving CB-relevant congestions shall be covered by TSOs responsible for the control areas in proportion to the aggravating impact of energy exchange between given control areas on the congested grid element. In other terms, costs of XRAs shall be covered by responsible TSOs in proportion to their contribution to the congestion on the congested XNE. The provision correctly reflects that, according to the PPP, TSOs contributing to the congestion need to be identified in order to make them contribute to the RA costs on XNEs.
214. Article 76(2) SO requires that, in determining whether congestion has CB relevance, TSOs shall take into account the congestion that would appear in the absence of energy exchanges between control areas.
215. First, as expressly set out in paragraph 133 of ACER Decision 33/2020 (ROSC), the threshold of ≥ 220 kV was set in accordance with the PPP articulated in Article 76 SO and took account of the structural congestion that would appear in the absence of energy exchanges. This threshold implies that, in the absence of energy exchanges, NEs ≥ 220 kV would not be congested and are thus XNEs.
216. Second, Article 76(2) SO refers to the absence of energy exchanges between control areas. This means that there is no explicit prohibition for other congestions to be taken into account. If the congestion that would appear in the absence of energy exchanges between control areas (i.e. between BZs) would be the only factor to distinguish between cross-border congestions and non-cross-border relevant congestions, then the congestion caused by LFs (due to energy exchanges within BZs) would not be considered as cross-border relevant. This would contradict the PPP of Article 16(13) ER.
217. To conclude, the scope of the Contested Decision’s RDCTCS has been set in accordance with the CACM, the ER and the PPP, both as articulated in Article 16(13) ER and in 76 SO. If a sub-set would be removed from the RDCTCS scope, compliance with this applicable regulatory framework could not be ensured.

1.1.8 The blending of the scope of RAs deriving from CROSA was decided upon by ACER Decision 07/2019 and not appealed.

218. Matching the scope of RAs following a CROSA process in RDCT and ROSC, and hence in RDCTCS, derives from ACER Decision 07/2019 on CSAM at EU level. ACER Decision 07/2019 which was addressed to All TSOs, including Core TSOs, has not been appealed, neither by Core TSOs nor by Core NRAs.

1.1.9 The RDCTCS scope is necessary and proportionate to attain the objectives of the CACM and the ER.

219. The EU applicable regulatory framework foresees coordinated methodologies to identify the optimal CM measures, regardless of their cost. A correct scope of the methodologies is therefore key, as it impacts *a priori* the choice of the most optimal CM measure and, hence, the essence of CM.
220. Impeding the inclusion of some NEs in costly RDCT whilst overly extending CC to NEs may affect the optimal CM choice: where CC processes do not prove to be the economically most efficient means to address congestion, TSOs have alternative measures to ensure OS. The Board of Appeal refers, in this regard, to the Eleventh Consolidated Plea on the principle of proportionality in relation to the RDCTCS scope.

1.1.10 The RDCTCS scope allows for exceptions upon common agreement by All Core TSOs.

221. The scope of the RDCTCS, RDCT and ROSC, applying to CNEs and NEs ≥ 220 kV, allows All Core TSOs to unanimously agree to exclude NEs ≥ 220 kV from its scope, as long as they are not CNEs.

1.2 The RDCTCS scope refers to other methodologies.

222. According to the Appellant II, the scope of the RDCTCS should expressly have been foreseen in the wording of the Contested Decision's RDCTCS, which should not refer to other methodologies (*in casu* based on Article 35 CACM and 76 SO) as regards its scope. Appellant II holds that "by reading the methodology, one is unable to unambiguously understand to what perimeter it shall apply" and claims that the RDCTCS "does not even refer to the relevant articles of the RDCT and ROSC decisions it refers to", which "had not been adopted at the time of the contested decision".
223. The Board of Appeal observes that it is not unusual for EU energy regulation to contain cross-references between methodologies. For example, the scope of ACER Decision 01/2020 on the methodology for pricing balancing energy and CZC used for the exchange of balancing energy or operating the imbalance netting process refers in its scope to the activation of balancing energy product bids for frequency restoration process with automatic activation, the frequency restoration process with manual activation and the imbalance netting process. Another example is ACER Decision 10/2020 on System Operation Regions, which refers to the CCRs that have already been defined in other regulatory decisions. This is due to the fact that various methodologies are often developed in parallel. Contrary to what Appellant II alleges, it is a manner to enhance legal certainty about the correct scope of intertwined methodologies.
224. Appellant II claims that, when voting on the RDCTCS of 18 November 2020, the Board of Appeal voted on an incomplete methodology. Appellant II alleges an infringement of the principle of legal certainty.
225. The Board of Appeal refers to Sub-Pleas 1.1.5 and 1.1.6, which evidence that the RDCTCS, ROSC and RDCT are intertwined.
226. The stakeholders during the RDCTCS, ROSC and RDCT decision-making processes, including the BoR approval process, are identical stakeholders. The same Core NRAs involved in the consultations on the RDCTCS were also involved in the consultations on the ROSC and RDCT. The decision-making process of the RDCTCS and the RDCT were carried out simultaneously (Core TSOs failed to meet the same deadline to submit a RDCT and RDCTCS on 17 March 2018 and the European Commission intervened in both proposal design processes; Core TSOs' RDCTCS and RDCT Proposal were both submitted on 22 February 2019; and a single Core NRAs' RDCTCS/RDCT Paper was issued on 27 March 2020). Moreover, at the 95th BoR meeting of 18 November 2020, the attendees were not only provided with the draft RDCTCS decision, but also with the draft ROSC decision and the draft RDCT decision. On 18 November 2020, even though voting was limited to the Contested Decision, Point 4.4. of the Agenda had foreseen discussions on the ROSC and RDCT⁵⁴. Those discussions are evidenced by the Minutes of the 95th BoR meeting: "*The Director presented the state of play relating to the Core and SEE methodologies on ROSC and the Core methodology on coordination of redispatching and countertrading, which aim to ensure coordination of operational security in Core and South-East Europe, and remedial actions in the Core CCR. The AEWG advice broadly endorses the draft decisions, which will be adopted via an electronic procedure to meet the 5 December deadline. The BoR Chair invited members to agree to the use of the electronic procedure, and opened the floor for discussion. The BoR agreed to the use of the electronic procedure.*"⁵⁵ BoR members were aware that the RDCTCS scope would be linked to the ROSC and RDCT since a long time, given that the

⁵⁴ https://acer.europa.eu/Official_documents/BoR/Meeting_Docs/A20-BoR-95-01.pdf

⁵⁵ https://acer.europa.eu/Official_documents/BoR/Meeting_Docs/A20-BoR-95-02.pdf, see also Annex 82 to the Defence

first draft RDCTCS decision that ACER's Director submitted to the BoR in September 2020 contained an identical proposed scope in its Article 1⁵⁶.

227. Appellant III similarly opposes the cross-references between methodologies because the purpose of the RDCT and ROSC are different. It makes a special reference to paragraph (58) of ACER Decision 35/2020: *"The question of cross-border relevance of network elements is addressed in Article 4 of the Proposal. The selection of cross-border relevant network elements ('XNEs') was based on the sensitivity threshold. Such provision is not consistent with the ROSC Methodology which specified that all critical network elements used at the capacity calculation, and all other network elements of 220 kV voltage level and above shall be considered as cross-border relevant, except those network elements which Core TSOs agree to exclude"*.
228. Paragraph 58 of ACER Decision 35/2020 correctly describes the fact that ACER, when carrying out its regulatory supervision of All Core TSOs' RDCT Proposal, assessed that the definition of XNEs had to match the definition of XNEs of All Core TSOs' ROSC Proposal. The Board of Appeal refers to Sub-Plea 1.1 regarding the reasons why the scope of the RDCTCS, RDCT and ROSC need to match.
229. According to Appellant III, the ROSC - a methodology for regional OS coordination, based on Article 76 SO - is meant to merely complement the RDCT and RDCTCS. Article 76 SO stipulates that the ROSC shall *"complement, where necessary, the methodologies developed in accordance with Articles 35 and 74 of Regulation (EU) 2015/1222."* Appellant III approves the inclusion of all internal NEs to ensure security of the network in accordance with Article 76 SO. In its view, the inclusion of internal NEs is justified when ensuring system security across BZs (Article 76 SO) but is not justified when providing a mechanism to execute XRAs that enable TSOs to effectively relieve physical congestion (irrespective of whether the reasons for the physical congestion fall mainly outside their control area), in accordance with Article 35 CACM. Distributing RDCT costs across borders does not, in its view, justify the inclusion of internal NEs.
230. Similarly, Appellant V claims that Article 2(2)(j) of the Contested Decision's RDCTCS erroneously refers to the CSAM and the ROSC. Article 2(2)(j) of the RDCTCS defines a XNE as *"a network element identified as cross-border relevant and on which operational security violations need to be managed in a coordinated way"*. This refers to Article 15(1) of ACER Decision 07/2019 (CSAM) and Article 5(1) of ACER Decision 33/2020 (ROSC). However in Appellant V's view, the scope of the RDCTCS, RDCT and ROSC are different. First, the RDCT and ROSC concern the activation of physical measures, whereas the RDCTCS aims at attributing ensuing costs of physical measures. The RDCT and ROSC are therefore governed by technical principles to decide on the activation of the measures, whereas the RDCTCS is governed by Article 16(13) ER and its PPP. Secondly, the RDCT and ROSC also differ. Appellant V distinguishes between (i) the RDCTCS, which is relevant for CC, covered by CACM and the PPP of Article 16(13) ER, and (ii) other cost sharing methodologies in the context of safeguarding OS, covered by SO, which *"complement"* the RDCTCS (Article 76 SO). The RDCTCS has, consequently, a limited scope, which cannot be identical to the scope of the ROSC.
231. The Board of Appeal refers to Sub-plea 1.1 above, which sets out that (i) the differentiation between material processes to ensure OS, governed by SO, on the one hand, and material processes enabling CB trade, governed by CACM, on the other hand, is incorrect; (ii) the applicable regulatory framework, to be found in the CACM and SO, links all 3 Core methodologies, whilst referring at the same time to the EU CSAM; (iii) at EU level, the CSAM requires an identification of NEs where OS violations need to be managed in a coordinated way and (iv) the Contested Decision complies with the PPP as articulated in Article 16(13) ER and Article 76 SO.

⁵⁶ Annex A.2.2 to Appeal VI.

232. At EU level, the debate as to whether to have two separate processes or one single process has already been held in the bottom-up decision-making process leading up to ACER Decision 07/2019 on the CSAM, when a similar distinction had been tabled by All TSOs to have separate processes for RAs under Article 35 CACM, on the one hand, and for RAs under Article 74 CACM, on the other hand. Paragraphs 65 to 67 of said decision state that ACER did not consider this approach compliant with the SO for 2 main reasons:

“(65) First, the SO Regulation does not allow to separate remedial actions that need to be managed in a coordinated way into two separate categories with different levels of coordination. In particular, Articles 21(1) and 76(1)(b) of the SO Regulation require that all remedial actions that need to be managed in a coordinated way be used to address operational security violations that need to be managed in a coordinated way and that this coordination ensure the identification of the most effective and economically efficient remedial actions. The Proposal would clearly legitimise two separate coordination procedures which would not be able to identify the most effective and economically efficient remedial actions to address operational security violations that need to be managed in a coordinated way.

(66) Second, the Proposal does not clearly specify that the coordination of cross-border impacting remedial actions is performed at regional level and the central coordination role is not given to the RSC as required by Articles 77 and 78 of the SO Regulation.

(67) Therefore, the Agency deems that the concept of cross-border relevant redispatching and countertrading actions and cross-border relevant congestions defined within the methodology referred to in Article 35 of the CACM Regulation cannot be separated from the concept of operational security violations and remedial actions that need to be managed in a coordinated way pursuant to Articles 21 and 76 of the SO Regulation, since all remedial actions that need to be managed in a coordinated way (including redispatching and countertrading) are required to be coordinated in one single coordination and optimisation process and not in two separate and materially different coordination procedures. With this respect, the requirement in Article 76(1) of the SO Regulation that the methodology pursuant to Article 76(1) of the SO Regulation shall ‘complement where necessary the methodologies developed in accordance with Articles 35 and 74 of the CACM Regulation’ can only be consistently implemented if the methodology pursuant to Article 76(1) of the SO Regulation encompasses the full scope of the methodologies pursuant to Articles 35 and 74 of the CACM Regulation and includes additional elements specifically required by the methodology pursuant to Article 76(1) of the SO Regulation. Any other implementation of the reference to ‘complement where necessary’ would not be compliant with Articles 21 and 76 of the SO Regulation.

(68) For the reasons above, the Agency replaced all references to the cross-border impacting remedial actions with the references to cross-border relevant remedial actions in order to ensure full consistency with the methodologies developed in accordance with Articles 35 and 74 of the CACM Regulation.”

233. A similar debate has taken place during the bottom-up decision-making process leading-up to ACER Decision 35/2020 (RDCT). The Explanatory Document to All Core TSOs’ RDCT Proposal of 5 September 2018, published for consultation⁵⁷, distinguished between CB relevance in accordance with Article 35(1) CACM and the broader concept of “CB impact” in accordance with Article 76 SO. However, as set out above, All Core TSOs’ RDCT Proposal was modified in order to amend the RDCT scope to CNEs and NEs ≥ 220 kV.

1.3 The RDCTCS scope should match a “significant impact”-test or the scope of DA and ID Core CCM.

234. According to Appellant II, a correct definition of “CB relevance” should limit the scope of the RDCTCS to a narrower scope in accordance with Article 16(13) ER, i.e. NEs that are significantly impacted by CB exchanges. This is, in Appellant II’s opinion, to avoid that CB exchanges are overly restricted by physical limitations in internal networks. Appellant IV also claims that the RDCTCS has to guarantee firmness of CZC in accordance with the DA Core CCM and ID Core CCM.

235. Appellant II claims that the RDCTCS should not match the scope of the coordinated security analysis (NEs ≥ 220 kV) but should, in accordance with Articles 20 and 21 CACM, be limited to congestions between 2 BZs, i.e. covering CNECs (NEs with a zone-to-zone PTFD $\geq 5\%$). Article 21(1)(b)(ii) CACM requires that rules are defined to avoid undue discrimination between internal and CZ exchanges. That is why critical NEs associated with contingency

⁵⁷ <https://eepublicdownloads.entsoe.eu/clean-documents/Network%20codes%20documents/Implementation/ccr/methodologies/core/cacm-deliverables/coordinated-rd-and-ct-art-35/201902-core-cacm-35-methodology.pdf>.

were defined (“CNECs”). In Appellant II’s view, only the capacity on CNECs can limit the global CZC made available for CZ exchanges. ACER Decision 02/2019 excludes internal NEs with contingency with a maximum zone-to-zone Power Transfer Distribution Factor (“PTDF”) < 5%, calculated as the time-average over the last 12 months, from the definition of CNECs.

236. Appellant V similarly claims that All Core TSOs’ RDCTCS Proposal correctly defined the RDCTCS scope to selected NEs with a PTDF $\geq 5\%$.

237. It is incorrect that Article 16(13) ER lays down a test for the RDCTCS scope in terms of significant impact. Article 16(13) ER relies upon the significant impact test of the definition of structural congestion according to Article 2(4) ER to determine a *de minimis* threshold for polluting flows.

238. The Contested Decision’s RDCTCS scope duly requires TSOs causing polluting flows to contribute to RA costs in accordance with Article 16(13) ER, which requires an identification of the polluter in accordance with the PPP.

239. The Board of Appeal reiterates the scope of the Contested Decision’s RDCTCS, which covers all CNEs of the CCM scope, but is not limited to CNEs:

XNEs =

Includes: • all CNEs (CCM) (according to a yearly list of CNEs):

- all CZ NEs
 - all internal NEs, defined by All Core TSOs, with a BZ-to-BZ PTDF $\geq 5\%$
- other NEs ≥ 220 kV

Excludes: XNEs that are not CNEs, i.e.:

- radial lines, distribution NEs, transformers with secondary voltage <220 kV
- other NEs as commonly agreed upon by All Core TSOs
- XNEs that are part of another CCR CROSA (for TSOs belonging to more than one CCR)

Source: Board of Appeal.

240. The Board of Appeal refers to Sub-plea 1.1, in which it sets out in detail the reasons why the scope of the RDCTCS needs to cover XNEs.

241. CCM and RDCTCS are two different short-term measures under CACM, which explains why they have a different scope.

242. CC processes consider RAs but do not apply RAs and, hence, do not create costs. They are aimed at maximising CB trade, whilst respecting OS and avoiding undue discrimination between internal and CB exchanges. DA and ID Core CCM are tools to maximise CB trade in case of congestion on the grid until enduring mid-term and long-term solutions are reached, whilst respecting OS. They are a short-term “safety net” and involve an efficiency assessment (including a cost assessment) of other short-term, mid-term and long-term solutions, e.g. RDCTs and their costs. As correctly stated by Appellant V in its Reply⁵⁸, RA optimisation and CC are not two separate processes, but clearly interlinked.

243. RDCT coordination processes apply RAs and therefore create costs that need to be shared.

244. As set out above in Sub-plea 1.1.2, impeding the inclusion of some XNEs in costly RAs whilst overly extending CC to XNEs may affect the optimal CM choice (a choice could be made for CC even it would not prove to be the economically most efficient means to address congestion). RAs are CM measures of last resort, close to real time. Hence, a restrictive approach on the XNEs to include in its scope would imply that there would remain no alternative solution to solve congestions on the excluded XNEs, threatening OS. Moreover, the exclusion of XNEs from RAO would not only maintain but even worsen OS issues in relation to these XNEs. Given that these NEs have cross-border relevance, they are impacted by RAs activated to solve violations on included XNEs. Wrongfully excluding such XNEs from the scope would not be able to eliminate their intrinsic cross-border nature. Indeed, cross-border relevance of XNEs involves the mutual interdependency of such XNEs and RAs

⁵⁸ Reply of Appellant V, para 247.

by laws of physics. Such excluded XNEs would, therefore, be impacted by RA activation on included XNEs, with likely negative OS consequences.

245. Under the CROSA process, the optimised and coordinated RDCT actions aim to relieve physical congestion on all XNEs (i.e. CNEs and NEs ≥ 220 kV), irrespective of whether the reasons for the physical congestion fall inside or outside the TSOs' control area.
246. The erroneous exclusion of XNEs from the CROSA scope has as a consequence that physical congestion will not be relieved on the excluded XNE and threatens OS on that XNE. Conversely, the erroneous inclusion of XNEs in the CROSA scope does not threaten OS because cross-border relevance depends on the laws of physics and the interdependency between XNE and RAs, which will simply not occur.
247. In Appellant II's view, the ER makes a clear distinction between congestion between BZs, referred to in Article 16(13) ER, and congestion within BZs, referred to in Article 14(2) ER. It alleges that the scope of congestion occurring between 2 BZs corresponds at least to congestions occurring on tie-lines, i.e. XNEs physically located between 2 BZs, and at most to congestions occurring on XNEs associated with a contingency, i.e. CNECs.
248. The Board of Appeal refers to Sub-plea 1.1.7 above, where it sets out that the RDCTCS scope is not limited to congestions between 2 BZs. Article 16(13) ER sets out that the PPP applies to congestions between 2 BZs but does not restrict the RDCTCS scope, which encompasses XNEs.
249. According to Appellant VI, the RDCTCS scope needs to be aligned with the definition and selection of CNECs in the DA Core CCM and ID Core CCM. This is because, in its view, there is a clear link between the RDCTCS and the CCM, which have a common basis in the CACM, whereas the ROSC is based on the SO and pursues different purposes, namely operational objectives in order to ensure the security of the electrical system. Appellant VI alleges that ACER acknowledges these different purposes. It refers to a presentation by ACER to NRAs and TSOs, which is reproduced⁵⁹:

1. Consistency between SO76 and CACM35

- » Proposals for SO76 and CACM35 are completely different but describe essentially the same process – high risk of inconsistent text or interpretation and consequent delays in implementation
- » Some elements of SO76 are not within CACM35: provision of input data, creation of CGM, operational security analysis, validation of recommended RDCT...
- » Some elements would only remain in SO76 (e.g. RSC governance)
- » Simple referencing is legally not possible: We cannot omit content from CACM35 because it needs to be assessed against CACM requirements
- » **Solution:**
 - » **Delay CACM35 Decision to align with SO76 timeline – both methodologies consulted and adopted together**
 - » **Copy Articles from SO76 into CACM35, where both methodologies describe the same underlying process (keep the scope only to RDCT)**

250. The Board of Appeal refers to Sub-plea 1.1 above, which sets out that (i) the differentiation between material processes to ensure OS, governed by SO, on the one hand, and material processes enabling CB trade, governed by CACM, on the other hand, is incorrect; (ii) the applicable regulatory framework, to be found in the CACM and SO, links all 3 Core methodologies, whilst referring at the same time to the EU CSAM; (iii) at EU level, the CSAM requires an identification of NEs where OS violations need to be managed in a

⁵⁹ Annex A.3.4 to Appeal VI: ACER presentation to NRAs and TSOs of 25 May 2020, slide 5.

coordinated way and (iv) the Contested Decision complies with the PPP as articulated in Article 16(13) ER and Article 76 SO.

251. As to the slide of ACER's presentation of 25 May 2020, the Board of Appeal observes, first, that the presentation has to be situated in the bottom-up, gradual, step-based and multipartite decision-making process leading-up to the Contested Decision. Its relevance is therefore limited to work-in-progress. Second, the slide underlines that both the RDCT and ROSC are based on the same CROSA process, even though they have their differences. The slide suggests using cross-references between the RDCT and the ROSC to the extent that this allows for a due assessment of the RDCT against Article 35 CACM. Third, the solution proposed by ACER in the slide is correct: "*delay*" ACER Decision 35/2020 (RDCT) "*to align with*" ACER Decision 33/2020 (ROSC), "*both methodologies consulted and adopted together*". This is what effectively happened: although the decision-making process for the adoption of ACER Decision 35/2020 (RDCT) had been carried out simultaneously with the decision-making process for the adoption of the Contested Decision, ACER Decision 35/2020 (RDCT) was delayed and not adopted on 30 November 2020 (together with the Contested Decision), but adopted on 4 December 2020, together with ACER Decision 33/2020 (ROSC).
252. Appellant III correctly states that one should distinguish between the CCM and the RDCTCS processes⁶⁰, given that the CCM process does not include the sharing of costs, whereas the RDCTCS amounts to cost sharing. That is precisely why the Contested Decision's RDCTCS scope goes beyond the scope of the CCM.

1.4 The RDCTCS scope infringes Article 74(2) CACM and is inconsistent per se.

253. According to Appellant II, the definition of the RDCTCS is inconsistent in itself, since it pretends that RDCT actions activated for the purpose of CROSA on all NEs ≥ 220 kV "*shall be considered as guaranteeing the firmness of cross-zonal capacities pursuant to the Core capacity calculation methodology*". The scope is therefore inconsistent with Article 74(2) CACM because it is larger than what is provided for in Article 74(4) CACM, i.e. guaranteeing the firmness of CZCs pursuant to the Core CCM.
254. Article 74(2) CACM requires the RDCTCS to "*include cost-sharing solutions for actions of cross-border relevance.*"
255. Article 74(4) CACM states that the RDCTCS shall "*at least: (a) determine which costs incurred from using remedial actions, for which costs have been considered in the capacity calculation and where a common framework on the use of such actions has been established, are eligible for sharing between all the TSOs of a capacity calculation region in accordance with the capacity calculation methodology set out in Articles 20 and 21; (b) define which costs incurred from using redispatching or countertrading to guarantee the firmness of cross-zonal capacity are eligible for sharing between all the TSOs of a capacity calculation region in accordance with the capacity calculation methodology set out in Articles 20 and 21; (c) set rules for region-wide cost sharing as determined in accordance with points (a) and (b)*".
256. Appellant II correctly states that Article 74(4)(b) requires the RDCTCS to, at least, define which costs incurred from using RDCT to guarantee firmness of CZC are eligible for sharing between all TSOs of Core CCR in accordance with the CCM set out in Articles 20 and 21 CACM.
257. This is consistent with the Contested Decision's RDCTCS scope, which includes, at least, CNEs as per CCM (as per Article 74(4)(b) CACM), but also includes NEs ≥ 220 kV in order to guarantee cost sharing solutions for XRAs (as per Article 74(2) CACM). Article 74(4) CACM requires the RDCTCS to provide a cost sharing solution that, at least, covers the costs from using RAs from CCM but Article 74(4) CACM does not limit the RDCTCS scope to the scope of the CCM. As set out above, this is due to the differences between CC processes and RDCT processes. The test of Article 74(2) CACM of "cross border relevance" requires a scope that covers all XRAs, without differentiating whether these RAs relate to internal XNEs or other XNEs. Also, the CROSA process does not differentiate between guaranteeing

⁶⁰ Appeal III, Plea 1, para 117.

firmness of CZC and ensuring OS. As acknowledged by Appellant II, “a remedial action activated to solve an overload on a network element may contribute to both ensuring the firmness of cross-zonal capacity and addressing loop flows originating from other bidding zones”⁶¹.

258. Appellants III and V also claim that the Contested Decision’s RDCTCS scope infringes Article 74(2) CACM, because it only allows for cost sharing on interconnectors or CNEs.
259. In Appellant IV’s view, the RDCTCS illegally defines its scope regardless of the effect of internal NEs on CB trade, because the legal basis only permits cost sharing on NEs significantly impacted by electricity trades between 2 BZs.
260. Appellant VI claims that the RDCTCS scope infringes Article 74(2) CACM because the definition of XNEs for the RDCTCS needs to be aligned with the logic of the definition and selection of CNECs in the Core DA Core CCM and ID Core CCM.
261. As set out in detail above in Sub-plea 1.1., Article 74(2) CACM requires the RDCTCS to include XRAs on XNEs. The test of “CB relevance” does not limit cost sharing to interconnectors, CNEs or congestions between BZs. The Contested Decision’s RDCTCS does not infringe Article 74(2) CACM but correctly complies with Article 74(2) CACM.
262. Similarly, Appellants IV and V claim that the RDCTCS scope infringes Article 74(2) CACM, which only permits cost sharing on NEs significantly impacted by electricity trades between 2 BZs. Appellant IV refers to Article 2(4) ER, which defines congestion as a situation in which all request from market participants to trade between network areas cannot be accommodated because they would significantly affect physical flows on NEs which cannot accommodate those flows.
263. Article 2(4) ER defines congestion as “a situation in which all requests from market participants to trade between network areas cannot be accommodated because they would significantly affect the physical flows on network elements which cannot accommodate those flows”.
264. Article 2(4) ER refers to structural congestion. As set out above, it is incorrect that Article 16(13) ER lays down a test for the RDCTCS scope in terms of significant impact. Article 16(13) ER requires the *de minimis* LF threshold to be determined “below the level that could be expected without structural congestion in a bidding zone”.
265. The test laid down for the RDCTCS scope is CB relevance and not structural congestion. Article 16(13) ER and its reference to a situation without structural congestion to determine a *de minimis* LF threshold is not capable of altering the scope of the RDCTCS, which per definition covers costs resulting from measures to relieve physical congestion (e.g. LFs from other BZs, which are unpredictable). Physical congestion is defined in Article 2(18) CACM as “any network situation where forecasted or realised power flows violate the thermal limits of the elements of the grid and voltage stability or the angle stability limits of the power system”.
266. Appellant II opposes paragraphs 64 to 66 of the Contested Decision, because they imply that all RDCT actions activated pursuant to CROSA will necessarily be XRAs and therefore subject to the RDCTCS.
267. Paragraphs 64 to 66 of the Contested Decision read as follows:
“(64) Articles 9 and 10 of the Proposal provide that the coordination process for the activation of redispatching and countertrading actions of cross-border relevance will activate these actions to solve congestions on two types of network elements, one type would be cross-border relevant and the other type non-cross-border relevant.
(65) However, ACER understands that this assumption is not correct, since the methodology for coordinated security assessment, adopted pursuant to Article 75(1) of the SO Regulation, determines that regional operational security coordination, which is used as the basis for the activation of redispatching and countertrading actions of cross-border relevance, shall solve congestions only on cross-border relevant network elements. The regional operational security coordination process that is set out in the above-mentioned methodology will not aim to resolve congestions on network elements which are not cross-border relevant network elements and therefore no redispatching and countertrading actions of cross-border relevance will be activated for such elements. This understanding is confirmed by Article 8 of the proposal for the Core methodology for regional operational security coordination pursuant to Article 76 of the SO Regulation, which specifies that cross-border relevant network elements are secured network elements and these in turn are the

⁶¹ Appeal II, Plea 7, para 157.

only elements on which the congestions are being resolved by the regional operational security coordination. (66) ACER therefore understands that redispatching and countertrading actions of cross-border relevance can only be used for resolving congestions on cross-border relevant network elements.”

268. The Board of Appeal refers to Sub-plea 1.1 above, which sets out the need for coordination of RAs in Core CCR and the role of OS in the EU electricity regulation. It also sets out how the EU electricity regulation has created a link between the CSAM, ROSC, RDCT and RDCTCS and how these methodologies have duly been linked. Sub-plea 1.1 also sets out how the RDCT and the ROSC refer to the same CROSA process by which RAs are optimised (graphically represented in Sub-plea 1.1.3). The definition of XNEs in CSAM amounts to NEs on which OS violations need to be managed in a co-ordinated way.
269. Appellant V opposes the wording of Recital (7) of the RDCTCS: *“While Article 16(13) of the Electricity Regulation defines a cost sharing solution for congestions between bidding zones, it does not specify the cost sharing solution for congestions that fall outside the scope of congestions between two bidding zones. Namely, Article 74(2) of the CACM Regulation requires the cost sharing methodology to determine cost sharing for all cross-border relevant redispatching and countertrading actions. Since the coordination process and RAO, in accordance with the methodology pursuant to Article 35 of the CACM Regulation and the methodology pursuant to Article 76 of the SO Regulation, apply cross-border relevant redispatching and countertrading actions to solve congestions on all cross-border relevant network elements (regardless of whether they are within the scope of congestion between two bidding zones or not), this cost sharing methodology must provide a cost sharing solution for all cross-border relevant network elements. For consistency, this methodology therefore applies the same polluter-pays principle as defined in Article 16(13) of the Electricity Regulation to all cross-border relevant network elements (regardless of whether they are within the scope of congestion between two bidding zones or not)”*.
270. The Board of Appeal refers to Sub-plea 1.1.7 above, which sets out how Article 16(13)ER does not alter the scope of RDCTCS, encompassing XNEs in accordance with Article 74(2) CACM.
271. Appellant III draws a clear difference between the cost-sharing process prior to mapping and the cost-sharing process after mapping. It alleges that, prior to mapping, the scope of the Contested Decision’s RDCTCS is lawful, but that after mapping, the scope of the Contested Decision’s RDCTCS is unlawful. Appellant III claims that, after mapping, the cost distribution should not include the broad scope of the Contested Decision’s RDCTCS but should be limited to interconnectors. Consequently, cost distribution on the basis of the PPP should only be applied to interconnectors. In Appellant III’s view, this interpretation is confirmed by the definition of relevance (i.e. the degree to which something is related or useful to what is happening or being talked about, as per the Cambridge Dictionary), which implies that the concept of CB relevance is inherently limitative and cannot imply the inclusion of internal NEs after mapping, especially when they are sufficiently included in the course of mapping.
272. The Board of Appeal refers to Sub-Plea 1.1. Article 74(2) CACM requires the RDCTCS to include XRAs on XNEs. The test of CB relevance does not exclude internal NEs, neither during mapping nor during the remaining steps of the RDCTCS pursuant to mapping.
273. The mapping process of the Contested Decision’s RDCTCS assigns the costs and revenues of each identified RA to a XNE that falls within the scope of the RDCTCS, on an hourly basis. Mapping is a first step of Title 3 of the Contested Decision’s RDCTCS. Mapping of XRA costs to XNECs corresponds with Article 5 of the Contested Decision’s RDCTCS. After mapping, Title 3 of the Contested Decision’s RDCTCS contains additional steps, namely flow decomposition on XNECs (Article 6) and distribution of costs on XNECs to TSOs (Article 7).
274. The Board of Appeal finds that, if the scope of the RDCTCS is narrowed down and excludes a sub-set of XNECs from the flow decomposition on XNECs and distribution of costs on XNECs (beyond the exceptions provided by the Contested Decision’s RDCTCS), this removal of a sub-set of XNECs after mapping infringes the CACM and the ER for exactly the same reasons that are provided in this First Consolidated Plea, in particular Sub-Plea 1.1.7. A differentiation between mapping and post-mapping steps within cost sharing does not alter the conclusions as to the lack of compliance with Article 74 CACM (e.g. as regards incorrect

incentives, TSOs' responsibilities and liabilities or the infringement of the principle of non-discrimination) and 16 ER (e.g. as regards the infringement of the principle of non-discrimination and a failure to apply the PPP).

1.5 The RDCTCS scope is not in line with the CSAM.

275. According to Appellant II, ACER Decision 07/2019 containing the CSAM does not distinguish between the coordination and cost sharing scope. In its view, the RDCTCS should also not differentiate between coordinating NEs and cost sharing NEs. Moreover, the CSAM foresees in its Article 15(2) a possibility that not all NEs covered by coordinated security analyses are subject to cost sharing.

276. The Board of Appeal refers to Sub-Plea 1.1, where it sets out that the Contested Decision's RDCTCS is compliant with the CSAM. RDCT and ROSC coordinate the identification of XRAs following the CROSA, whereas the RDCTCS provides a cost sharing solution for XRAs following the CROSA. The Contested Decision's RDCTCS does not differentiate between coordinating and cost sharing.

Article 15(2) CSAM reads as follows: *"The common provisions for regional operational security coordination pursuant to Article 76(1) of the SO Regulation shall define the rules and/or criteria to establish the XNEs for which the costs attributed to them shall be shared among the involved TSOs and the XNEs for which the costs attributed to them Methodology for coordinating operational security analysis 21 shall be covered solely by the XNE connecting TSO(s), taking into account rules for cost sharing in accordance with Article 74 of the CACM Regulation."* Article 15(2) CSAM provides that rules and/or criteria need to be defined to establish the definition XNEs for which the cost of XRAs shall be shared. That is precisely what the Contested Decision's RDCTCS does. Hence, it is consistent with the CSAM.

1.6 The RDCTCS scope wrongly includes internal NEs.

277. Appellant II claims that the RDCTCS scope should not include internal NEs beyond CNECs. According to Appellant IV, RDCTCS triggered by IFs— i.e. physical flows on NEs where source and sink are located in the same BZ – are by their very nature not costs for XRAs but costs for RAs of mere domestic relevance. It claims that they should be excluded from the RDCTCS scope.

278. Appellant II also claims that, given that the very nature of the internal NEs is different from NEs subject to RDCTCS according to Article 74(2) CACM, paragraph 70 of the Contested Decision erroneously states that excluding internal NEs from the RDCTCS scope would be discriminatory in relation to other XNEs potentially impacted by the same polluting flows. In its view, internal NEs are different and different situations should be treated differently.

279. Appellant III differentiates between internal NEs and internal CNECs as per CCM. Appellant III claims that the RDCTCS scope wrongly includes internal NEs that are not CB NEs (interconnectors) after mapping.

280. The Board of Appeal notes, as a preliminary remark, that the present analysis under Sub-Plea 1.6 complements its analysis of the compatibility of the RDCTCS scope principle of non-discrimination in the Twelfth Consolidated Plea.

281. As set out above in Sub-Pleas 1.1 and 1.3, the RDCTCS scope including internal NEs is necessary to ensure compliance with the applicable regulatory framework set by CACM and ER. A removal of internal NEs from the scope would infringe both Article 74(2) of the CACM, which requires the RDCTCS to apply to XNEs, and Articles 16 ER, 74 and 3 CACM, which require the RDCTCS not to discriminate, to apply the PPP to polluting flows after having set a *de minimis* threshold. Article 16(13) ER clearly states that the application of the PPP requires an analysis to what extent flows resulting from transactions internal to BZs contribute to the congestion. Flows resulting from transactions internal to BZs are IFs or LFs and need to be identified in the decomposition of flows on XNECs (Article 6 of the Contested Decision's RDCTCS).

282. The Board of Appeal observes that one should carefully differentiate between the scope, on the one hand, and the distribution of costs, on the other hand.
283. Regarding the scope, all XNEs should be included, also internal XNEs (which host and cause a variety of flows, not only IFs). Appellant II's claim that the scope of the RDCTCS should be narrowed down in order to reduce the penalisation of LFs is contrary to the CACM, which requires a cost sharing solution for XNEs, and the ER, which requires a due application of the PPP when sharing costs among TSOs in relation to burdening LFs. By removing internal XNEs from the scope of the RDCTCS, as suggested by Appellant II, TSOs causing LFs that congest those internal XNEs would not be accountable under the PPP and a situation of free-riding would be created.
284. Regarding the distribution of costs, the RDCTCS (i) sets a *de minimis* threshold for LFs above which they contribute to the costs, whereas it does not set any threshold for IFs; (ii) prioritizes LFs above the threshold, which come first in the flow stack, over IFs, which come second in the flow stack; and (iii) applies the PPP to LFs above the threshold and applies the OPP to IFs. The Board of Appeal notes that, given the fact that IFs are created by the owners of internal NEs, applying the OPP or the PPP to IFs would place the cost burden on the same TSO.
285. The claim that internal NEs are different from other NEs and that, hence, treating them differently would not be discriminatory, is erroneous. Cost sharing derives from RAs to relieve congestion on NEs. RAs to relieve congestion on internal NEs are not different from RAs to relieve congestion on other NEs. Hence, there is no different situation justifying a different treatment under the principle of non-discrimination. Internal NEs may be different in many perspectives from other NEs, but there is no difference when it comes to RAs and hence, introducing a difference when it comes to sharing the costs of RAs would be discriminatory.
286. In its Reply, Appellant II merely states that "*network elements beyond CNECs on which the remedial actions are performed under the coordination process (i.e. network elements with a voltage higher than or equal to 220kV which do not qualify as CNECs in the Core capacity calculation process) are not comparable to CNECs*", but fails to substantiate the difference⁶².
287. Appellant III also claims that, even if the RDCTCS scope were to correctly exclude internal NEs after mapping, the RDCTCS scope wrongly includes internal CNEs that are not CB NEs (interconnectors). According to paragraph 47 of Appellant III's Appeal, including all internal CNEs after mapping (even though all internal NEs were correctly excluded) "*would lead to an even worse situation for the German TSOs and network users*". This, in its opinion, is because (i) the internal CNEs are, by definition, specifically burdened with too many IFs, rendering them "critical" NEs, and (ii) only a few LFs from other BZs could lead to overload situations which need to be resolved by RAs. Appellant III refers to Article 2(69) ER, which defines CNEs as "*network elements either within a bidding zone or between bidding zones taken into account in the capacity calculation process, limiting the amount of power that can be exchanged*". Therefore, CNEs are, in its opinion, limited to NEs limiting CB trade, as used in DA and ID Core CCM. Appellant III claims that the inclusion of internal NEs/CNEs is sufficiently done in the course of mapping to ensure that RAs contributed by internal NEs are not borne by CB NEs. In its view, internal NEs/CNEs should not be done after mapping, i.e. it should not be expanded to flow decomposition and flow stacking
288. The Board of Appeal refers to Sub-plea 1.1 above, which sets out that the exclusion of internal NEs would infringe Article 74 CACM as well as Article 16 ER. This statement is valid in relation to an alleged exclusion of internal NEs or internal CNEs. As set out above, the Board of Appeal observes that the scope of the RDCTCS should be identical during and after mapping.

⁶² Reply of Appellant II, para 16.

289. The Board of Appeal refers to Sub-plea 1.3 above, which sets out that CNEs used in DA and ID Core CCM are part of the RDCTCS scope but that limiting the RDCTCS to CNEs would infringe both Article 74 CACM and 16 ER.

1.7 The RDCTCS scope infringes Article 16(8), 16(4) and 16(13) ER.

290. According to Appellants III and IV, Articles 16(8) and (13) ER are *lex superior (lex generalis)* and *lex posterior* and limit the scope of the RDCTCS to congestions on interconnections between BZs. The RDCTCS taken on the basis of Article 74 CACM needs to comply with said Article 16(8) and (13) ER, as expressly provided for by Article 74(6)(b)(d) and (f) CACM.
291. Appellant IV alleges that Article 16(8) ER refers only to “interconnection capacity” when determining the 70% transmission capacity to be made available to the market for CB trade. The 30% of the interconnection capacity is the legitimate level of LFs until the TSOs determine a legitimate LF threshold per BZB. Appellant III adds that Article 16(8) ER prohibits TSOs from restricting interconnection capacities to relieve internal network congestions in their own BZ and are financially penalised in case of non-compliance (Article 16(12) ER).
292. Appellant V also considers that Article 74(2) CACM cannot go beyond Article 16(13) ER.
293. Intervener I supports Appellant III and alleges that the determination of NEs eligible for cost sharing infringes Article 16(13) ER and Article 74(b) and (c) CACM. Intervener I alleges that the ER is a *lex superior* and *lex posterior* and that Article 16(13) ER refers to “congestion between two bidding zones” and “for each individual BZ”, hence narrowing the scope of the RDCTCS. It adds that the Contested Decision’s RDCTCS is inconsistent with the responsibilities of the TSOs and does not provide a fair distribution of costs.
294. Article 74(6)(b) CACM requires the RDCTCS to “be consistent with the responsibilities and liabilities of the TSOs involved (...)”
295. Article 74(6)(d) CACM requires the RDCTCS to “be consistent with other related mechanisms, including at least: (i) the methodology for sharing congestion income set out in Article 73; (ii) the inter-TSO compensation mechanism, as set out in Article 13 of Regulation (EC) No 714/2009 and Commission Regulation (EU) No 838/2010 (1)”. (emphasis added)
296. Article 74(6)(f) CACM requires the RDCTCS to “facilitate adherence to the general principles of congestion management as set out in Article 16 of Regulation (EC) No 714/2009.”
297. Article 16(8) ER states as follows: “Transmission system operators shall not limit the volume of interconnection capacity to be made available to market participants as a means of solving congestion inside their own bidding zone or as a means of managing flows resulting from transactions internal to bidding zones. Without prejudice to the application of the derogations under paragraphs 3 and 9 of this Article and to the application of Article 15(2), this paragraph shall be considered to be complied with where the following minimum levels of available capacity for cross-zonal trade are reached: (a) for borders using a coordinated net transmission capacity approach, the minimum capacity shall be 70 % of the transmission capacity respecting operational security limits after deduction of contingencies, as determined in accordance with the capacity allocation and congestion management guideline adopted on the basis of Article 18(5) of Regulation (EC) No 714/2009; (b) for borders using a flow-based approach, the minimum capacity shall be a margin set in the capacity calculation process as available for flows induced by cross-zonal exchange. The margin shall be 70 % of the capacity respecting operational security limits of internal and cross-zonal critical network elements, taking into account contingencies, as determined in accordance with the capacity allocation and congestion management guideline adopted on the basis of Article 18(5) of Regulation (EC) No 714/2009. The total amount of 30 % can be used for the reliability margins, loop flows and internal flows on each critical network element.”
298. Article 16(12) ER states: “The financial consequences of a failure to honour obligations associated with the allocation of capacity shall be attributed to the transmission system operators or NEMOs who are responsible for such a failure. Where market participants fail to use the capacity that they have committed to use, or, in the case of explicitly auctioned capacity, fail to trade capacity on a secondary basis or give the capacity back in due time, those market participants shall lose the rights to such capacity and shall pay a cost-reflective charge. Any cost-reflective charges for the failure to use capacity shall be justified and proportionate. If a transmission system operator does not fulfil its obligation of providing firm transmission capacity, it shall be liable to compensate the market participant for the loss of capacity rights. Consequential losses shall not be taken into account for that purpose. The key concepts and methods for the determination of liabilities that accrue upon

failure to honour obligations shall be set out in advance in respect of the financial consequences, and shall be subject to review by the relevant regulatory authority.”

299. First, the creation of the RDCTCS is mandated by Article 74 CACM, which is an implementing act of the ER and expressly sets out in Article 74(6)(f) that it should “*facilitate adherence to the general principles of congestion management as set out in Article 16 of Regulation (EC) No. 714/2009*”(emphasis added). The RDCTCS relates to RDCTs, which are CM measures, whereas Article 16 ER contains the “*general principles of capacity allocation and congestion management*”, i.e. it covers a wider scope of CACM, i.e. CM and CA. Regardless of the fact that the general principles of Article 16 ER have been adopted after the CACM, the Contested Decision’s RDCTCS needs to comply with the ER to the extent that they are CM principles, because RDCT are CM measures and not CA measures. Yet the general principles of Article 16 ER contain both CA and CM measures.
300. Second, the Board of Appeal refers to Sub-plea 1.1 above, which sets out that the Contested Decision’s RDCTCS complies with the general principles of CM contained in Article 16 ER, especially Articles 16(1) and (13)ER. In other terms, the Contested Decision complies with both the CACM and the higher-ranking ER.
301. Third, even though Article 16(8) and (12) ER contain general principles of CA (maximising interconnection capacity or CZC up to 70% and penalties in case of non-compliance), the correct definition of XNEs in the Contested Decision’s RDCTCS does not impede reaching the expected level of 70% of CZC on a NE without structural congestion. The fact that interconnection capacity or CZC should be maximised to 70% does not imply that the scope of the RDCTCS should be limited to interconnectors.
302. Appellants III, IV and V claim that Article 16(13) ER contains a cost sharing solution for congestion between 2 BZs and not for congestion within a BZ (that is why the acceptable LF threshold needs to be set for each individual BZB). In their view, internal NEs cannot be considered as NEs between 2 BZs. Appellant V alleges that the PPP⁶³ only applies to the allocation of costs of RAs required as a result of “*congestions between 2 bidding zones observed*”.
303. As set out above in Sub-Plea 1.1.7, the Contested Decision’s RDCTCS is in line with Article 16(13) ER.
304. Appellant V holds that the RDCTCS is linked to the capacities available for CZ trade and to Article 16(4) ER, which provides that RAs need to maximise available capacities of interconnectors and the NEs affected by CB capacity. In its view, given that maximisation of existing capacities presupposes a correct CC, only the CNEs of the DA Core CCM and ID Core CCM (ACER Decision 02/2019) can be included in the RDCTCS, i.e. (i) CZ NEs and (ii) NEs with a PTDF $\geq 5\%$ which TSOs have selected and included in a specific list. Hence, NEs with a PTDF $< 5\%$ cannot be included in the RDCTCS scope.
305. Article 16(4) ER states: “*The maximum level of capacity of the interconnections and the transmission networks affected by cross-border capacity shall be made available to market participants complying with the safety standards of secure network operation. Counter-trading and redispatch, including cross-border redispatch, shall be used to maximise available capacities to reach the minimum capacity provided for in paragraph 8. A coordinated and non-discriminatory process for cross-border remedial actions shall be applied to enable such maximisation, following the implementation of a redispatching and counter-trading cost-sharing methodology.*”
306. The Board of Appeal refers to Sub-plea 1.3 above, which sets out that CNEs used in DA and ID Core CCM are part of the RDCTCS scope but that limiting the RDCTCS to CNEs would infringe both Article 74 CACM and 16 ER.
307. Article 16(4) ER contains the general principle of CACM according to which (i) RDCTs shall be used to maximise capacity as provided by Article 16(8) ER (minimum 70% of CZ trade), following a CROSA and (ii) the RDCTCS will apply to such RDCTs. Again, Article 16(4) ER does not restrict the RDCTCS scope to RDCTs used to maximise capacity but indicates

⁶³ Appellant V calls it the “causer’s principle”, which is identical to the PPP.

that such RDCTs will be subject to the RDCTCS. This is in line with the Contested Decision's RDCTCS, which includes CNEs (as per CCM) but is not limited to CNEs and also covers NEs ≥ 220 kV.

308. In Appellant IV's view, ACER's justification of the RDCTCS scope is based on a circular reasoning: ACER states that XNEs must be taken into account and then defines almost all NEs as being XNEs on the basis of Article 74(2) CACM and the PPP of Article 74(6)(i) and 3(e) CACM. At the Oral Hearing, Appellant IV held that there would be nothing left beyond the boundless scope and added that this scope is not necessary for cost sharing but for operational security.
309. As set out above in Sub-plea 1.1, the reasoning behind the decision as to the scope of the RDCTCS is not circular. To achieve the objectives of CACM and the ER, it is necessary for the scope of RDCTCS to be wider than interconnectors, CNEs, CZ NEs or significantly impacted NEs. A narrower scope would not achieve the objectives of the applicable regulatory framework.
310. In Appellant III's view, the Contested Decision does not correctly apply the PPP but effectively creates a system of free-riding cross-subsidization. In its view, costs on internal NEs/CNEs should be borne by the TSOs operating the congested internal NEs/CNEs. Instead, the RDCTCS puts the cost burden deriving from internal NEs on TSOs from whose network LFs originate, who are obliged to pay for internal congestions in networks operated by other TSOs. Appellant III adds that a LF's direction may be influenced by the constitution and load situation in a specific network system in another BZ, but that the flows are not caused by TSOs but by the trading activities within a BZ. That reinforces, in its opinion, the fact that TSOs operating the congested NEs have to pay for the needed RAs. In its Reply, Appellant III alleges that the concept of cross-border relevance does not mean being significantly affected by LFs⁶⁴.
311. The Board of Appeal refers to Sub-pleas 1.1.7 and 1.6, which set out that the Contested Decision's RDCTCS correctly applies the PPP with respect to internal NEs.
312. The costs to be shared under the RDCTCS are costs that stem from RAs to relieve congestion on NEs. Therefore, when sharing costs in accordance with the PPP, the burdening factor is the contribution to the congestion through electricity flows. This is expressly set out by Article 16(13) ER, which requires that the physical flows resulting from electricity exchanges or transactions internal to BZs - i.e. IFs and LFs - should be identified as contributors to the congestion. It further requires that, when allocating costs, the ensuing cost sharing methodology allocates them to TSOs of the BZs causing such flow, based on the contribution to the congestion to TSOs of BZs.
313. In case of CZ NEs, these flows are LFs, whereas in case of internal NEs, these flows are IFs and LFs (IFs caused by electricity exchanges within the BZ where the NE is located and LFs caused by electricity exchanges within other BZs). Since TSOs causing IFs are financing the investment and maintenance of such internal NEs via network fees or tariffs, whereas TSOs causing LFs are not, the LFs beyond a legitimate level (i.e. the level that could be expected without structural congestion in a BZ) should be identified as the primary contributor to the congestion on internal NEs, whereas IFs should be penalised only for the remaining volume of congestion.
314. Appellant III erroneously reverses the PPP and applies it to the polluting flow hosting TSOs, which Article 16(13) ER does not identify as polluters that should contribute to the RDCTCS. In the absence of IFs or LFs from polluting flow causing TSOs, the internal NEs of the polluting flow hosting TSOs would not be congested. Article 16(13) ER does not define pollution as a lack of maintenance or investment. Pollution is clearly defined as the contribution to the congestion through electricity flows.

⁶⁴ Reply of Appellant III, para 28.

315. Appellant VI adds that it follows from the wording of Article 16(13) ER that XNEs eligible for RDCTCS can be either tie-lines between 2 BZs or those NEs whose flow is sensitive to CB flows – on the basis of the definition of CNEs and CNECs incorporated into the Core DA and ID Core CCM. Appellant VI refers to Article 2(69) ER, which states that XNE means “a network element either within a bidding zone or between bidding zones taken into account in the capacity calculation process, limiting the amount of power that can be exchanged”. In Appellant VI’s view, ACER cannot depart from this established definition and that ACER used it in its Recommendations 02/2016 and 01/2019.
316. The Board of Appeal refers to Sub-Plea 1.1.7 above, which sets out that the RDCTCS scope is not limited to congestions between 2 BZs. Article 16(13) ER sets out that the PPP applies to congestions between 2 BZs but does not restrict the RDCTCS scope, which applies to XNEs. As set out in Sub-plea 1.1.7, the RDCTCS scope is fully in line with ACER’s Recommendation 02/2016.
317. The Board of Appeal refers to Sub-Plea 1.3 above, which sets out that CNEs used in DA and ID Core CCM are part of the RDCTCS scope but that limiting the RDCTCS to CNEs would infringe both Article 74 CACM and 16 ER. The RDCTCS scope is fully in line with ACER’s Recommendation 1/2019 on the implementation of the minimum margin available for CZ trade pursuant to Article 16(8) ER⁶⁵.
318. Appellant VI alleges that, contrary to the ROSC – which is based on Article 76 SO and does not have to be interpreted in the light of Article 16(ER) - the RDCTCS is based on Article 74 CACM, and therefore needs to be applied and interpreted in the light of Article 16(13) ER.
319. The Board of Appeal refers to Sub-plea 1.1 above, which sets out the need for coordination of RAs in Core CCR and the role of OS in the EU electricity regulation. It also sets out how the EU electricity regulation has created a link between the CSAM, ROSC, RDCT and RDCTCS and how these methodologies have duly been linked. Sub-plea 1.1 also sets out how the RDCT and the ROSC refer to the same CROSA process by which RAs are optimised (graphically represented in Sub-plea 1.1.3). The definition of XNEs in CSAM amounts to NEs on which OS violations need to be managed in a co-ordinated way
320. Appellant VI alleges, in that respect, that Article 16(13) ER, which is directly applicable, provides legal certainty, whereas ACER does not offer objective criteria to determine what it considers to be CB relevant and what would not.
321. The Board of Appeal refers to Sub-plea 1.1.7, which sets out that the Contested Decision’s RDCTCS duly complies with Article 16(13) ER. As to an alleged infringement of the principle of legal certainty, Article 3(3) of the Contested Decision’s RDCTCS clearly and unequivocally refers to Article 5(1) of the RDCT and Article 5(1) of the ROSC, which have an identical scope, that is clear and unequivocal:

XNEs =

Includes: • **all CNEs (CCM)** (according to a yearly list of CNEs):

- all CZ NEs
- all internal NEs, defined by All Core TSOs, with a BZ to BZ PTDF $\geq 5\%$
- **other NEs ≥ 220 kV**

Excludes: XNEs that are not CNEs, i.e.:

- radial lines, distribution NEs, transformers with secondary voltage <220 kV
- other NEs as commonly agreed upon by All Core TSOs
- XNEs that are part of another CCR CROSA (for TSOs belonging to more than one CCR)

Source: Board of Appeal.

1.8 The RDCTCS scope infringes Article 74(6)(a) CACM.

322. Article 74(6)(a) CACM states that the RDCTCS shall provide incentives to invest effectively.

⁶⁵ https://www.acer.europa.eu/Official_documents/Acts_of_the_Agency/Recommendations/ACER%20Recommendation%2001-2019.pdf

323. Appellants III and V claim that the allocation of costs to other BZs does not incentivize TSOs of the congested NE to invest into the required network expansion. In its view, charging German network users to pay for resolving internal congestions within non-German networks does not incentivise non-German TSOs to resolve their internal congestions at the expense of its own network users. This is unreasonable because German TSOs and network users have no tools to remedy non-German internal congestions. Appellant V adds that this forces TSOs from other BZs to pay for such lack of investments and the ensuing lack of network upgrades.
324. Appellant IV claims that the RDCTCS scope attributes costs for IFs which have been caused due to insufficient investment and maintenance of the respective congested internal NEs, which therefore are not sufficiently dimensioned to accommodate internal trading within a BZ, to TSOs who are neither responsible for those IFs nor for the lack of investment in the respective NEs those IFs congest. In its opinion, the RDCTCS consequently fails to provide incentives to TSOs to invest effectively in their respective NEs or in their internal grid expansion, since they can rely on the costs being shared with other TSOs through the RDCTCS. Appellant IV claims that the RDCTCS provides the wrong incentive to avoid and delay investments. Moreover, other TSOs (i) are not competent to invest in the network infrastructure of the TSOs whose NEs are congested due to IFs; and (ii) even though they could invest in their own network infrastructure, this would not alleviate internal congestions of the TSOs whose NEs are congested by IFs.
325. Appellant IV also disagrees with the Contested Decision's statement at paragraph 71 that there are other means for other TSOs to alleviate congestions on internal NEs caused by IFs, e.g. CC, RAs or reconfiguration of their own BZs. Appellant IV claims that paragraph 71 of the Contested Decision is incoherent when referring to Article 16(1) ER and to Article 5 of the DA Core CCM and ID Core CCM. This is because the DA Core CCM and ID Core CCM set out a mechanism compelling TSOs to take account of even less critical CNECs, putting the PTFD threshold higher and excluding more NEs outside of the CCM scope (Article 5(8)(b) of the DA Core CCM and ID Core CCM)
326. Appellant V claims that the RDCTCS scope will make TSOs pay from BZs that created the LFs. It adds that, even RD costs relating to small tie-lines located in remote areas - which do not constitute CNEs – could be passed on to TSOs in other BZs but that such RD measures do not lead to increasing CZC and hence do not support CZ trade. In its view, overcoming congestions is the sole obligation of the TSOs whose network is congested.
327. Appellant III differentiates between internal NEs and internal CNEs but alleges that the inclusion of both creates wrong incentives for investments. As regards internal CNEs, Appellant III alleges that their inclusion enhances the share of the costs to be borne by TSOs in whose BZ more LFs are created.
328. Intervener I supports Appellant III and alleges that the determination of NEs eligible for cost sharing infringes Article 74(6)(a) CACM because the incentive for effective grid investments would only be distributed in a fair manner between TSOs by consideration of CB lines only, as it would still follow the PPP without creating any negative incentives to prevent from grid investments where they are actually required.
329. Article 74(6)(a) CACM, which requires the RDCTCS to *“provide incentives to manage congestion, including remedial actions and incentives to invest effectively”*.
330. As set out above, a distinction needs to be made between the scope of the RDCTCS and the cost distribution of the RDCTCS.
331. As set out above, internal XNEs need to be included in the scope of the RDCTCS. Removing internal XNEs from the scope of the RDCTCS would imply that, on the one hand, LF-causing TSOs would not have to pay the costs although they did not sufficiently invest in their electricity network or did not change their BZ configuration in order to reduce LFs that pollute internal XNEs owned by LF-hosting TSOs whereas, on the other hand, LF-hosting TSOs would have to bear these costs. Moreover, if the RDCTCS were not to apply to internal XNEs, this would lead to the unfair situation that TSOs facing congestion on a BZB due to

LFs would be entitled to cost sharing whereas TSOs facing congestion on other XNEs (not on a BZB) would not be entitled to cost sharing. Not applying the RDCTCS to internal XNEs would not provide the correct incentives to LF-causing TSOs to take the necessary measure to reduce their LFs below the legitimate LF threshold, e.g. through investments in network upgrades. Furthermore, as set out by ACER in its Defence, solving LFs on LF-causing XNEs is a prerequisite for LF-causing TSOs in order to solve problems of IFs causing internal congestion.

- 332.Regarding cost attribution of IFs, the Contested Decision's RDCTCS applies the OPP when attributing costs of IFs on a XNEC to TSOs. IFs are borne by the XNE connecting TSOs.
- 333.Claiming that the requirement that the polluting flow hosting TSOs should contribute to the costs amounts to a reversal of the PPP. Article 16(13) ER does not identify polluting flow hosting TSOs as polluters that should contribute to the RDCTCS. Article 16(13) ER does not define pollution as a lack of maintenance or investment. Pollution is clearly defined as the contribution to the congestion through electricity flows.
- 334.With respect to paragraph 71 of the Contested Decision, it reads as follows: *“Excluding some cross-border relevant network elements from cost sharing would also contradict the general principles of congestion management in accordance with Article 16(1) of the Electricity Regulation by which network congestion problems should be addressed with non-discriminatory market-based solutions which give efficient economic signals to the market participants and transmission system operators involved. This general principle was applied in ACER Decision 02/2019 of 21 February 2019 on the Core CCR TSOs' proposals for the regional design of the day-ahead and intraday common capacity calculation methodologies. Articles 5 of Annexes I and II of this Decision set out the requirements for Core TSOs to continuously monitor and identify the most efficient congestion management method for congestions on internal network elements, among which are capacity calculation, remedial actions, reconfiguration of bidding zones and network investments. The solution by which congestion problems can be addressed with remedial actions crucially depends on the coordination of remedial actions and related cost-sharing. Thus, in the absence of cost-sharing for specific congested network elements, remedial actions could no longer be considered as an alternative congestion management method for these elements. As a consequence, this would prevent efficient congestion management as required by Article 16(1) of the Electricity Regulation.”*
- 335.Regarding the statement in paragraph 71 that there are alternative means for other TSOs to alleviate congestions on internal XNEs caused by IFs, e.g. CC, RAs or reconfiguration of their own BZs and that the Contested Decision's RDCTCS is inconsistent with the CCM, the Board of Appeal refers to Sub-Pleas 1.1.2, describing RAs in a zonal market model, and 1.1.7, which sets out that the exclusion of internal XNEs from the scope of the RDCTCS would not only undermine cost sharing under the RDCTCS, but also undermine a correct functioning of the ROSC and RDCT and even negatively affect efficient overall CACM in the Core CCR. This is because, according to the CCM (ACER Decision 02/2019), Core TSOs are under an obligation to continuously monitor and identify the most efficient CM method for congestions on internal NEs, e.g. CC, RAs, BZ reconfiguration or network investments and their decision to address congestions with RAs depends on the coordination of RAs and related cost-sharing. In the absence of cost sharing for specific congested NEs, RAs could no longer be considered as an alternative CM method for those NEs. This would automatically prevent efficient CM as required by Article 16(1) ER. CCM and CROSA need to be fully integrated as both are measure foreseen by CACM. Through the identification of the most effective CM measures, CACM aims at maximising CZC and ensuring OS.
- 336.Appellant III adds that, apart from the wrong incentives to TSOs, the RDCTCS sets incentives that contradict the European goal of completing the internal electricity market by fostering CB trade and market integration of renewable energies, in particular the climate neutrality goal for 2050. TSOs of BZs with more renewable energy, and their consumers, need to contribute to resolve internal congestions on networks of TSOs that do not use renewable energy.
- 337.The objective of the RDCTCS is not to penalise TSOs from BZs with renewable energy.
- 338.First, climate change measures require investments that can only adequately be carried out in a Core region that is coordinated in terms of RAs. An adequate level of coordination in terms of RDCTs and OS can only be achieved through a corollary cost sharing system, as provided

for in the RDCTCS. As set out above, the RDCTCS plays a role in the identification of the most effective CM measures under CACM aims to maximise CZC and ensure OS. In so doing, the Contested Decision's RDCTCS has been designed in way that ensures an adequate level of investments in the long term and provides correct economic signals in accordance with 74 CACM and 16 ER, whilst fostering integration of Core CCR in terms of congestions. This adequate level of investments will foster, in the long term, correct investment initiatives by All Core TSOs and a smooth transition of the entire Core CCR towards decarbonisation.

339. Second, as more renewable energy is connected, OS challenges will increase across the EU. RES are prone to causing LFs. Given the time lags associated with new transmission investment and BZ reconfiguration, short periods of high RDCT costs are possible. This means that it is particularly important to ensure co-ordination in the execution of RAs in order that overall costs to network users in the EU are minimised.
340. In this regard, the Board of Appeal refers to Recital 23 ER, which states: *While decarbonisation of the electricity sector, with energy from renewable sources becoming a major part of the market, is one of the goals of the Energy Union, it is crucial that the market removes existing barriers to cross-border trade and encourages investments into supporting infrastructure, for example, more flexible generation, interconnection, demand response and energy storage. To support this shift to variable and distributed generation, and to ensure that energy market principles are the basis for the Union's electricity markets of the future, a renewed focus on short-term markets and scarcity pricing is essential.*"

1.9 The RDCTCS scope infringes Article 74(6)(b) CACM.

341. In Appellant II's opinion, given that TSOs are responsible for the adequate operation of and investments in their networks, other TSOs must not be made liable of the costs resulting from these network operation and investment decisions. Appellant II evidences this by providing a figure of total RDCT volumes in Core and non-Core BZs in GWh in 2015, 2017 and 2019, based on ACER Market Monitoring Reports and stresses that there is a variety of policies and RAs to address congestion.
342. Appellant III stresses that the inclusion of costs for RAs on all internal NEs after mapping and allocation of costs to other BZs disregards the internal responsibility of the TSO of the congested NE.
343. Article 74(6)(b) CACM states that the RDCTCS shall be consistent with the responsibilities and liabilities of the TSOs involved.
344. Costs on XNEs are duly attributed to All Core TSOs in accordance with the PPP as regards LFs above the threshold and in accordance with the OPP as regards IFs (taking account of the fact that applying the OPP or the PPP to IFs will be similar in terms of cost attribution given the nature of IFs) and other flows.
345. The scope of the Contested Decision's RDCTCS does not impede Core TSOs to bear their responsibilities and liabilities. As set out above in Sub-plea 1.1.7, the removal of a subset of XNEs from the scope of the RDCTCS would be contrary to Article 74(6)(b) CACM because All Core TSOs would be infringing their obligations under Article 74 CACM and 16 ER when failing to apply a cost sharing solution to all XNEs. Not sharing costs under the RDCTCS would leave all costs with the TSOs that own congested XNEs.

1.10 The RDCTCS scope infringes Recital (12) CACM and 16(4) ER.

346. Appellant III alleges that the CACM and ER differentiate between XRAs and other RAs, e.g. internal RAs or other non-XRAs. In its opinion, Recital (12) CACM and Article 16(4) ER expressly make this differentiation. It claims that Article 16(4) ER differentiates between, on the one hand, "counter-trading and redispatch", and, on the other hand, "CB redispatch".
347. Recital (12) CACM states: *"TSOs should implement coordinated redispatching of cross-border relevance or countertrading at regional level or above regional level. Redispatching of cross-border relevance or countertrading should be coordinated with redispatching or countertrading internal to the control area."*
348. Article 16(4) ER states: *"The maximum level of capacity of the interconnections and the transmission networks affected by cross-border capacity shall be made available to market participants complying with the*

safety standards of secure network operation. Counter-trading and redispatch, including cross-border redispatch, shall be used to maximise available capacities to reach the minimum capacity provided for in paragraph 8. A coordinated and non-discriminatory process for cross-border remedial actions shall be applied to enable such maximisation, following the implementation of a redispatching and counter-trading cost-sharing methodology.”

349. The Board of Appeal refers to Sub-plea 1.7, which sets out that Article 16(4) ER does not restrict the RDCTCS scope to RDCTs used to maximise capacity but indicates that such RDCTs will be subject to the RDCTCS.
350. Furthermore, the text of Article 16(4) ER merely states that RDCTs shall be used to maximise capacity following a CROSA and that these RDCTs shall include CB RDs. It does not by any means imply any exclusion of internal RAs from XRAs.
351. Recital (12) CACM does not imply any exclusion of internal RAs from the RDCTCS scope. It refers to the fact that the introduction of regional coordination of RAs should take account of on-going national coordination of RAs.
352. Appellant VI holds that, in the absence of a definition of “CB relevance” in Recital (12) CACM, reference needs to be made to the ER. Yet Articles 2(4) and 16(13) ER do not use the term “CB relevance” but refer to the congestion between 2 BZs and trade between network areas. Therefore, the RDCTCS scope needs to be aligned with the definition and selection of CNECs in the DA Core CCM and ID Core CCM.
353. The Board of Appeal refers to Sub-plea 1.3 above, which sets out that CNEs used in DA and ID Core CCM are part of the RDCTCS scope but that limiting the RDCTCS to CNEs would infringe both Article 74 CACM and 16 ER.

1.11 The RDCTCS scope infringes Article 35 CACM and 2(4) ER.

354. Appellant III alleges that Article 35(2) CACM states that XRAs shall only be established in order to resolve CB relevant congestions. Appellant III also refers to Article 2(4) ER and Recital (64) of ACER Decision 35/2020 (RDCT). Hence, in Appellant III’s opinion, only RAs exercised to relieve capacity problems between BZs, i.e. interconnectors, should be included in the RDCTCS scope.
355. Article 35(2) CACM states: *“The methodology for coordinated redispatching and countertrading shall include actions of cross-border relevance and shall enable all TSOs in each capacity calculation region to effectively relieve physical congestion irrespective of whether the reasons for the physical congestion fall mainly outside their control area or not. The methodology for coordinated redispatching and countertrading shall address the fact that its application may significantly influence flows outside the TSO’s control area.”*
356. Article 2(4) ER defines congestion as *“a situation in which all requests from market participants to trade **between network areas** cannot be accommodated because they would significantly affect the physical flows on network elements which cannot accommodate those flows”* (emphasis by Appellant III).
357. Recital (64) RDCT reads as follows: *“The coordination requirements of Article 35 of the CACM Regulation can be summarised into the requirement for coordination of redispatching and countertrading actions of cross-border relevance **in order to address physical congestions which are also cross-border relevant**. In doing so, TSOs should ensure economic efficiency and effectiveness of these actions.”* (emphasis by Appellant III).
358. As set out above in Sub-plea 1.1.7, a limitation of the scope of the RDCTCS to interconnectors would not only infringe Article 74(2) CACM, but also undermine cost sharing under the RDCTCS, undermine a correct functioning of the ROSC and RDCT and even negatively affect efficient overall CACM in the Core CCR.
359. The Board of Appeal refers to Sub-plea 1.1 for the correct definition of CB relevance, which corresponds with CB relevance referred to in Recital (64) and Article 35(2) RDCT. The test laid down for the RDCTCS scope is CB relevance and not congestion.

1.12 The RDCTCS contradicts the creation of the internal energy market.

360. Appellant III claims that the RDCTCS scope contradicts the objective of the CACM and ER to create the internal energy market, which is essentially done through fostering CB trade. Hence, the crucial role of making available CB capacities, also by using RAs. In its view,

including RA costs exercised on all internal NEs after mapping leads to an excessive cost sharing of RAs without the necessary CB relevance, whereas the objective of an internal electricity market implies that TSOs pay for congestions on their own NEs no matter where the flow contributing to the congestion stems from. In its opinion, the only acceptable exception is the congestion of interconnectors because as long as BZ limits exist, interconnectors need to be treated differently.

361. Appellant III quotes Recitals (20) and (21) ER:

“(20) When regional coordination centres carry out a capacity calculation, they should maximise capacity considering non-costly remedial actions and respecting the operational security limits of transmission system operators in the Capacity Calculation Region. Where the calculation does not result in capacity equal to or above the minimum capacities set out in this Regulation, regional coordination centres should consider all available costly remedial actions to further increase capacity up to the minimum capacities, including redispatching potential within and between the capacity calculation regions, while respecting the operational security limits of transmission system operators of the Capacity Calculation Regions. Transmission system operators should report accurately and transparently on all aspects of capacity calculation in accordance with this Regulation and should ensure that all information sent to regional coordination centres is accurate and fit for purpose.”

(21) When performing capacity calculation, regional coordination centres should calculate cross-zonal capacities using data from transmission system operators which respects the operational security limits of the transmission system operators' respective control areas. Transmission system operators should be able to deviate from coordinated capacity calculation where its implementation would result in a violation of the operational security limits of network elements in their control area. Those deviations should be carefully monitored and transparently reported to prevent abuse and ensure that the volume of interconnection capacity to be made available to market participants is not limited in order to solve congestion inside a bidding zone. Where an action plan is in place, the action plan should take account of deviations and address their cause.”

362. As set out above in Sub-plea 1.1.7, a limitation of the scope of the RDCTCS to interconnectors would not only infringe Article 74(2) CACM, but also undermine cost sharing under the RDCTCS, undermine a correct functioning of the ROSC and RDCT and even negatively affect efficient overall CACM in the Core CCR.

363. The Board of Appeal refers to Sub-pleas 1.3 and 1.7 in relation to the difference between the scope of the CC processes, which is included in the RDCTCS scope, on the one hand, and the scope of the RDCTCS, which is broader and encompasses XNEs, on the other hand.

364. Appellant III's claim that the requirement that the polluting flow hosting TSOs should contribute to the costs amounts to a reversal of the PPP. Article 16(13) ER does not identify polluting flow hosting TSOs as polluters that should contribute to the RDCTCS. Article 16(13) ER does not define pollution as a lack of maintenance or investment. Pollution is clearly defined as the contribution to the congestion through electricity flows.

365. The Board of Appeal finds that the scope of the Contested Decision's RDCTCS does not go counter the EU internal electricity market, but that narrowing the RDCTCS scope to interconnectors would infringe Article 74(6)(e) CACM, which requires the RDCTCS to *“(e) facilitate the efficient long-term development and operation of the pan-European interconnected system and the efficient operation of the pan-European electricity market”*. As set out above, it would not only obliterate cost sharing under the RDCTCS, but also undermine a correct functioning of the ROSC and RDCT and negatively affect efficient overall CACM in the Core CCR.

1.13 The RDCTCS scope infringes the principle of subsidiarity.

366. Appellant II⁶⁶ claims that the RDCTCS scope infringes the principle of subsidiarity.

367. Article 5(3) TEU reads as follows: *“Under the principle of subsidiarity, in areas which do not fall within its exclusive competence, the Union shall act only if and in so far as the objectives of the proposed action cannot be sufficiently achieved by the Member States, either at central level or at regional and local level, but can rather, by reason of the scale or effects of the proposed action, be better achieved at Union level. The institutions of the Union shall apply the principle of subsidiarity as laid down in the Protocol on the application of the principles of subsidiarity and proportionality. National Parliaments ensure compliance with the principle of subsidiarity in accordance with the procedure set out in that Protocol.”*

⁶⁶ Appeal II, Plea 6, para 148.

368. Recital (45) ACER Regulation confirms that the objective of the Regulation is to grant competences to the Agency precisely because cooperation of NRAs at EU level and their participation in the exercise of EU-related functions cannot be sufficiently achieved by the Member States acting by themselves and confirms that, in so doing, the Regulation respects the principle of subsidiarity and proportionality.
369. In line with its earlier decision-making practice⁶⁷, the Board of Appeal holds that the principle of subsidiarity does not come into play in the present plea. As is clearly set out in Article 5(3) TEU, the principle of subsidiarity governs the attribution of competence to the EU or to the Member States in areas of shared competence. ACER took the Contested Decision on the basis of its exclusive competence set out in Article 6(10)(a) of the ACER Regulation. Appellant II confirms in its Appeal that ACER's competence is based on Article 6(10) of the ACER Regulation. Given that it did not challenge the validity of Article 6(10) of the ACER Regulation on the basis of which the Contested Decision was taken, its arguments on the principle of subsidiarity are immaterial.
370. In addition, even if Appellant II would have challenged the validity of Article 6(10) of the ACER Regulation, *quod non*, it must be reminded that ACER was jointly requested by the NRAs, pursuant to Article 9(11) CACM, to issue the Contested Decision by virtue of Article 6(10) of ACER Regulation.
371. Appellant II refers in its Reply⁶⁸ to Recital (29) ACER Regulation to sustain its claim.
372. Recital (29) ACER Regulation reads as follows: "*In accordance with the principle of subsidiarity, ACER should adopt individual decisions only in clearly defined circumstances, on issues that are strictly related to the purposes for which ACER was established.*"
373. Recital (29) expresses that the competences, attributed to ACER by the ACER Regulation to adopt individual decision in clearly defined circumstances on issues that are strictly related to the purposes for which ACER was established, are in accordance with the principle of subsidiarity.
374. **It follows that the First Consolidated Plea must be dismissed as unfounded.**
375. Appellants' claims on an infringement of the PPP are dealt with separately in the Eighth Consolidated Plea.
376. Appellants' claims on an infringement of the principle of proportionality are dealt with separately in the Eleventh Consolidated Plea.
377. Appellants' claims on an infringement of the principle of no discrimination are dealt with separately in the Twelfth Consolidated Plea.
378. Appellants' claims on ACER's competence are dealt with separately in the Fourteenth and Fifteenth Consolidated Pleas.
379. Appellants' claims on an infringement of duty to reason are dealt with separately in the Seventeenth Consolidated Plea.

Second Consolidated Plea – Unlawful inclusion of NEs covered by Action Plans in the RDCTCS scope.

380. Appellant II⁶⁹ claims that the Contested Decision's RDCTCS infringes Article 15(3) ER and Article 74(6) CACM because it should have excluded all CNECs covered by APs. Even though Appellant II acknowledges that Article 15(13) ER only provides for the exclusion of RA costs to achieve linear trajectory or make CZC available at BZBs or CNEs concerned by an Action Plan ("AP"), it claims that all CNEs covered by an AP should be excluded from the scope of RDCTCS given the impossibility to trace the exact purpose of RA costs. It adds that

⁶⁷ Board of Appeal Decisions A-001-2019, para 51; A-001-2020, paras 129-131; A-002-2020, paras 130-132; and A-003-2020, paras 211-213.

⁶⁸ Reply of Appellant II, para 21.

⁶⁹ Appeal II, Plea 7, paras 151-161.

an insufficient exclusion of RA costs due to APs does not provide incentives to TSOs to adopt measures to address structural congestion.

381. Appellant VI⁷⁰ claims that the inclusion of all RDCT costs to meet APs infringes the PPP unless the eligible costs for RDCTCS are further delineated to ensure that only the costs of resolving congestion caused by LFs and IFs are shared and that the necessary incentives remain in place for a Member State to resolve the structural congestion on its own network and as required by its AP.
382. ACER's Defence⁷¹ rejects the plea arguing that the RDCTCS complies with the exact wording foreseen by Article 15(3) ER and that there is a difference in scope between APs, aimed at addressing structural congestions, and the RDCTCS, aimed at addressing physical congestions, namely LFs from other BZs (over a certain threshold).

2.1 The decision-making process leading-up to the Contested Decision.

383. As will be set out below in the Fourteenth Consolidated Plea, ACER adopted the Contested Decision on the basis of Article 6(10)(a) ACER Regulation and, to this end, it carried out the regulatory supervision of All Core TSOs' RDCTCS Proposal under Article 74 CACM, which stipulates in Article 74(6)(f) that the RDCTCS needs to facilitate adherence to the general principles of CM as set out in Article 16 ER.
384. All Core TSOs' RDCTCS Proposal does not contain specific rules regarding NEs concerned by APs. The All Core TSOs' RDCTCS Explanatory Document⁷² does not make any reference to APs.
385. All Core NRAs' Non'-Paper⁷³ evidences divergent positions as to whether NEs concerned by APs should be included in the RDCTCS scope or not.
386. All Core TSOs' Non-Paper⁷⁴ contains comments by Appellant I on the interaction of the RDCTCS with APs. However, it does not contain any statement by Appellant VI on the interaction of the RDCTCS with APs.
387. The Board of Appeal concludes that, in carrying out its functions of regulatory supervision, ACER had to take account of the fact that All Core TSOs' RDCTCS Proposal did not contain specific rules regarding NEs concerned by APs, whilst taking due account of the views of All Core NRAs. ACER had to ensure that All Core TSOs' RDCTCS Proposal complied with the applicable regulatory framework.
388. The Contested Decision's RDCTCS does not contain specific rules regarding NEs concerned by APs.

⁷⁰ Appeal VI, Plea 5, paras 226-241.

⁷¹ Defence, Plea 1, paras 299-311.

⁷² Annex 13 to the Defence.

⁷³ Annex A.3.2 to Appeal VI.

⁷⁴ Annex 79 to the Defence.

2.2 The unlawful inclusion of NEs covered by Action Plans in the Contested Decision.

389. Article 15 ER allows Member States facing identified structural congestions to develop an AP in cooperation with their NRA to reduce these congestions. This allows them to derogate from the minimum capacity level of 70% that has to be offered for CZC on each BZB or CNE in accordance with Article 16(8) ER and allows them to annually increase CZC levels by means of a linear trajectory until they reach the level of 70% by 31 December 2025.
390. Article 15(2) ER requires these Member States to ensure that, during the implementation of their AP, they make CZC available that is at least equal to the values of the linear trajectory, including by the use of RAs, in their CCR.
391. Article 15(3) ER provides for an exception to the PPP, whereby Member States implementing APs bear certain RA costs, *inter alia*, costs to make CZC available until the capacity reaches the expected level of 70% on a NE without structural congestion. Article 15(3) ER reads as follows: “3. The cost of the remedial actions necessary to achieve the linear trajectory referred to in paragraph 2 or make available cross-zonal capacity at the borders or on critical network elements concerned by the action plan shall be borne by the Member State or Member States implementing the action plan.” The OPP applies in those cases.
392. The Board of Appeal refers to the First Consolidated Plea, Sub-Pleas 1.1.3, 1.6 and 1.8. regarding (i) the difference in scope between the CC process and the CROSA process and (ii) the lawful inclusion of internal NEs in the RDCTCS scope. The determination of RAs under the CROSA process is sequential to the CC process and this determination of RAs is a CM measure of last resort. Therefore, the inclusion of NEs in the RDCTCS scope ensures that all costs of the RAs that are necessary to achieve the linear trajectory or to make available CZC are supported by the MS owning the XNEC.
393. Both Article 15 ER and Article 16(8) ER are aimed at ensuring that, even in the event of an AP due to identified structural congestions, a minimum capacity is guaranteed for CZ trade in a BZ or BZs of a Member State by 31 December 2025. Given that the objective of ensuring a minimum level of capacity for CZ trade underpins both provisions, the exemption of Article 15(3) ER should be strictly limited to situations where it is necessary to achieve the linear trajectory or to make CZC available, as correctly set out in paragraph 78 of the Contested Decision: “ACER considers that the costs of remedial actions which are not stemming from making available the required level of cross-zonal capacities should still be subject to cost sharing in accordance with the cost sharing methodology. With this regard ACER notes that the adopted cost sharing methodology by default allocates all the costs attributed to a specific network element to the TSO which owns such network element (i.e. the TSO in whose control area such network element is connected or located), except for the costs which are caused by congestions created by loop flows originating from other bidding zones. These costs are then borne by the TSOs of these other bidding zones that create such loop flows.”
394. The exemption from the PPP needs to be understood in relation to the objective to guarantee minimum capacity levels by 2025: the OPP is temporary allowed because APs gradually increase CZC. The exemption provides incentives to Member States to gradually increase CZC through APs and allow for the application of the PPP once the AP has addressed the congestion and CZC levels have been increased. This is in line with Recital (27) ER: “[...] Clear minimum levels of available capacity for cross-zonal trade need to be put in place in order to reduce the effects of loop flows and internal congestions on cross-zonal trade and to give a predictable capacity value for market participants”.
395. APs and their related linear trajectory are designed to address structural congestion in a BZ (or BZs) of a Member State, as defined by Article 2(4) ER, i.e. a situation in which all requests from market participants to trade between network areas cannot be accommodated because they would significantly affect the physical flows on network elements which cannot accommodate those flows. Articles 2(19) of the CACM and 2(6) ER define structural congestion as “congestion in the transmission system that can be unambiguously defined, is predictable, is geographically stable over time and is frequently reoccurring under normal power system conditions”. APs reflect identified, unambiguously defined and predictable

congestion in the BZ(s) of a Member State. They are not related to physical congestion caused by LFs from other BZs, which are unpredictable.

396. APs are aimed at gradually reducing the predictable congestion resulting from the BZ(s) of a Member State and, as such, allowing for a gradual increase of CZC in that Member State. An increase of unpredictable LFs from other BZs would hinder this process. Excluding those LFs from cost sharing under the RDCTCS would not only hinder the effectiveness of APs in a Member State (not being able to increase CZC despite APs and, hence, not complying with Article 15(2) ER) but also provide wrong incentives to neighbouring Member States. Indeed, the latter would not receive adequate incentives to take the necessary measures to avoid LFs.
397. Appellant II alleges that the Contested Decision infringes Article 74(6)(a) CACM, which requires the RDCTCS to “provide incentives to manage congestion, including remedial actions and incentives to invest effectively”. It claims that, in the absence of a full exclusion of all NEs covered by APs from the RDCTCS, “the incentives for the TSOs concerned by action plans to actually develop measures to address structural congestions and reach the 70% required by Article 16(8) of the Electricity Regulation would be weakened. TSOs would not face the full costs of remedial actions on these network elements while they benefit from an exemption to provide only a limited capacity to cross-zonal exchanges. Yet one of the main objectives of the RDCT cost sharing methodology is, according to Article 74(6)(a) of the CACM Regulation, precisely to provide incentives to manage congestion. Contrary to this objective, sharing costs on those lines would encourage Member States to implement action plans understood as an exemption to the 70% and to delay the implementation of Article 16(8) of the Electricity Regulation since RDCT costs on those CNECs would anyway be shared between TSOs.”⁷⁵
398. The starting point of this reasoning is that APs are considered a negative from a CZC perspective and should not be encouraged. APs are, however, a temporary exception to provide only limited CZC in the short term and allow Member States to reach minimum CZC levels in the longer run. APs have to be encouraged as they foster the attainment of minimum CZC capacity in 2025. If LFs from other BZ hamper APs, they should be discouraged in order to allow APs to attain their long term objective to increase CZC in a Member State. LFs from other BZ are discouraged by having their costs shared and included in the RDCTCS. It is erroneous to hold that the inclusion of LFs from other BZs in cost sharing will discourage TSOs from Member States with APs - relying on their exception - not to develop measures to address congestions in order to increase CZC.
399. That is precisely what APs are designed for: the development of short term measures to address structural congestion in a Member State and to allow this Member State to gradually increase CZC and attain the 70%-threshold in the long term. Excluding LFs from other BZs from cost sharing under the RDCTCS would not provide the necessary incentives to neighbouring Member States to take measures to reduce polluting LFs.
400. The Board of Appeal finds that there is no reason justifying the application of the OPP in situations not covered by the express wording of Article 15(3) ER. Yet there are reasons to apply the PPP to these situations: physical congestions caused by LFs from other BZs (over a certain threshold) hinder APs. As set out by ACER in its Defence, “the action plan relates to the actions of a Member State by which it is able to comply with the 70% target (e.g., network investments), but if the network of such Member State is continuously polluted by loop flows from other bidding zones, there is no action that a Member State can do to achieve the 70% target”⁷⁶. In this respect, Article 15(3) ER does not aim at contradicting the PPP in case of APs, but rather at safeguarding and reinforcing it.
401. This is correctly set out in 79 of the Contested Decision: “The action plan should gradually reduce the level of loop flows and internal flow resulting from the bidding zone of a Member State applying the action plan, which should allow for a gradual increase of cross-zonal capacities. However, this may not be possible if during this period the loop flows from other bidding zones would increase and no cost sharing with polluter-pays principle would be applied for these loop flows. Excluding all network elements concerned by the action plan from the cost sharing would not allow the Member State applying the action plan to increase cross-zonal capacities, because there would be no cost sharing for congestions caused by loop flows originating from

⁷⁵ Appeal II, Plea 7, para 160.

⁷⁶ Defence, Plea 1, para 305.

neighbouring bidding zones. Such a solution would, on the other hand, provide perverse incentives to neighbouring Member States. With this respect, Article 15(3) of the Electricity Regulation does not aim at contradicting the polluter-pays principle in case of action plans, but rather to safeguard and reinforce it.”

402. Pursuant to Art. 15(3) ER, the fact that a XNEC is concerned by an AP does not imply that every (costly) RA, which would relieve physical congestion on this XNEC, is necessary (i) to achieve the linear trajectory - i.e. to make available less than 70% of CZC - or (ii) to make available 70% of CZC of this XNEC. As set out by ACER in its Rejoinder⁷⁷: on the one hand, if a coordinated XRA only tackling the congestion related to LFs is sufficient to reach the above objectives (i) or (ii), a Member State does not need to incur in any cost for RAs to reach these objectives; on the other hand, if such a coordinated XRA is not sufficient to reach objectives (i) or (ii), a Member State needs to incur in costs for RAs necessary to reach these objectives. Reasoning otherwise would lead to an incorrect interpretation of Art. 15(3) ER as it would be irreconcilable with the context and the objectives of the EU energy framework. If the costs of RAs applied to solve congestions resulting from LFs above the legitimate threshold are not shared based on the PPP, Member States owning the XNEC may not be able to increase CZC (despite the requirement under Art. 15(2) ER) because APs are unable to reduce LFs from neighbouring BZs, and Member States from which LFs originated would not be incentivised to invest or change their BZ configuration in order to avoid such LFs, in violation of Art. 74(6)(b) CACM Regulation.
403. The importance of the correct incentives is correctly underlined by Appellant II in its Reply: *“Furthermore, several Member States have had recourse to further regulatory instruments to precisely address the issue of loop flows in complement of the issue of structural congestion addressed by their action plan.”*⁷⁸
404. Consequently, the Contested Decision’s RDCTCS is also in line with Article 74(6)(b) CACM, which requires the RDCTCS to *“be consistent with the responsibilities and liabilities of the TSOs involved (...)”*, because it includes LFs from other BZs above the threshold in cost sharing and applies the PPP to these situations. This is in line with the responsibility and liability of TSOs for physical congestions caused by LFs. Doing otherwise would unlawfully place an additional burden on Member States implementing APs, that would be unrelated to APs and, moreover, would hinder those APs to produce the desired effects.
405. **It follows that the Second Consolidated Plea must be dismissed as unfounded.**
406. Appellants’ claims on an infringement of the PPP are dealt with separately in the Eighth Consolidated Plea.

Third Consolidated Plea – Decomposition of flows.

407. Appellant V⁷⁹ claims that Article 6 of the Contested Decision’s RDCTCS, and in particular the PFC method and the assumptions to HVDC NEs, infringe the ER, CACM and ACER Regulation. Appellant V provides a description of the FLD method, which it developed, and provides technical details on the FLD method in the annexes to its Appeal⁸⁰. Appellant V sets out the methodological differences between the FLD method and the PFC method. It claims that the FLD method is a preferable method and it was not formally rejected on the basis of any justified technical or legal grounds.
408. First, Appellant V alleges that the PFC method ignores electrical distance, creates fictional flows and thereby obstructs any reasonable cost attribution, infringing Articles 2(3) and (52), 16(13) and 49(1),(2) and (5) ER, 74(5) and (6) CACM and 76(1)(b)(v) SO. It adds that the Contested Decision’s inconsistency with the zonal market model or with the CC process infringes Articles 3 and 74 CACM and Recital (14) ER.

⁷⁷ Rejoinder, para 10.

⁷⁸ Reply of Appellant II, para 26.

⁷⁹ Appeal V, Plea 2, paras 46-178.

⁸⁰ Confidential version of Annex 9 to Appeal V and Annexes 10, 11 and 12 to Appeal V. A non-confidential version of Annex 9 to Appeal V has been provided by Appellant V and shared among parties.

409. Second, Appellant V claims that the PFC approach uses a Generation Shift Key (“GSK”) for flow decomposition, which infringes Recitals 67 and 68, Articles 16(4) and (13) and 43 ER, and Articles 3 and 74(3) and (6) CACM.
410. Third, Appellant V raises procedural concerns regarding ACER’s explanation of its choice for the PFC approach and use of GSKs, infringing Articles 14(7) ACER Regulation and 296 TFEU and the general principles of EU Law including Article 41(2)(c) of the Charter.
411. Fourth, Appellant V claims that restrictions made within a cost sharing methodology regarding the power flow via HVDC elements violate (i) the PPP of Articles 16(13) ER and 74(6)(c) CACM; (ii) Articles 16(1) ER, 3 and 74(6) CACM and 4(c)(i) of Regulation (EU) 347/2013 on guidelines for trans-European energy infrastructure by setting wrong incentives, not reflecting the efficient long-term development and operation of the pan-European interconnected system and electricity market and being discriminatory and (iii) Articles 2(3) and 3(h) ER by contradicting the definition and requirements of CB flow.
412. In its Defence⁸¹, ACER sets out the differences between the PFC and FLD method. It highlights 2 disqualifying features of the FLD method that infringe Article 16(13) ER, namely (i) the calculation of a considerable amount of AFs even in situations where there are no CZ exchanges between BZs and no AFs should exist and (ii) the underestimation of the level of LFs because it assumes that generation nodes in North Germany never supply load nodes in South Germany (whereas LFs caused by a BZ are impacted by that BZ’s internal trade). On the PFC method, the Defence furthermore sets out that the Contested Decision’s RDCTCS does not violate the PPP of Article 16(13) ER due to technically unjustified cost burdening. It stresses that the Contested Decision’s RDCTCS is consistent with (i) the cost sharing mechanism for costs resulting from multilateral RAs (Article 76(1)(b)(v)SO); and (ii) the inter-TSO compensation mechanism (“ITC”) (Article 49 ER and Regulation (EU) 838/2010). It adds that the Contested Decision’s RDCTCS does not violate further statutory requirements. It sets out that consistency with the zonal market model and CC process is a legitimate reason for choosing the PFC method. Furthermore, the Defence argues that the use of GSK in the Contested Decision’s RDCTCS is appropriate and sets out that the restrictions on HVDC NEs do not infringe the PPP, do not set wrong incentives for CM, correctly reflect the efficient long-term development and operation of the EU interconnected system and electricity market, are not discriminatory and do not contradict the definition and requirements of CB flows. Finally, the Defence alleges that all procedural obligations were respected when choosing the flow decomposition method.
413. Article 6 of the Contested Decision’s RDCTCS, entitled “*Flow decomposition on XNECs*” reads as follows:
- “1. All Core TSOs shall calculate at least for each XNEC with attributed costs pursuant to Article 5(5) and for each hour the following components of flows, which shall be used for cost sharing:
- (a) PST flow, representing the component of physical flow resulting from the effect of using all PSTs located within and outside the Core CCR as determined within the CGM;
 - (b) Allocated flow, representing the component of physical flow resulting from all cross-zonal exchanges within and outside the Core CCR;
 - (c) Loop flow from outside the Core CCR, representing the component of physical flow resulting from internal exchanges within all bidding zones outside Core CCR;
 - (d) Loop flow for each bidding zone in the Core CCR, representing the component of physical flow resulting from internal exchanges within each bidding zone within the Core CCR; and
 - (e) Internal flow, in case the eligible XNEC is an internal network element, representing the component of physical flow resulting from internal exchanges within the bidding zone where an XNE is located.
2. For the purpose of transparency and auditability, Core TSOs may calculate different subcomponents of the flow components pursuant to paragraph 1.
3. The first step of the flow decomposition shall be to perform the Alternating Current (AC) load flow calculation on a CGM, for the topology without any contingency (base case) and then separately for each contingency. The active power network losses shall be recorded per each network element (for base case and for each contingency) in the CGM. These losses shall be assigned to the sending end of each branch (omitting the virtual

⁸¹ Defence, paras 332-376 and 389-415.

nodes representing the boundary points, in which case the losses shall be appointed to the real node at the receiving end), thus preparing the injections for further power flow decomposition, which is linearised from this point onwards.

4. The power flow decomposition is performed by calculating the:

- a) node-to-hub PTDF matrix, which is calculated with linearised approach, providing information of the sensitivity of active power flow over an XNEC, to the power exchange between each node containing nodal injections and arbitrarily selected hub node;
- b) nodal injections for allocated flows as defined in paragraph 6; and
- c) nodal injections for loop flows and internal flows as defined in paragraph 7 The PST flows are the flows that the PST is generating at the actual tap position at the two connection points of each PST.

5. The PST flow pursuant to paragraph 1(a) on a single XNEC is calculated by summing up the contributions of individual PSTs on that same XNEC. The PST flow by a single PST is determined via phase shifter distribution factors (PSDF). The PSDF expresses the change of MW flow on a network element for the change of one tap of that PST. PSDF is calculated as the difference in physical flow on an XNEC, when changing the tap of this PST from currently applied tap to the next tap. Then the PST flow is calculated by multiplying all PSDF with the differences between the tap positions of phase shifting transformers contained in the CGM and their neutral tap position.

6. The nodal injections for allocated flows are calculated by multiplying the net positions contained within the CGM, with the factors contained within the GSK that is used in the application of day-ahead capacity calculation methodology and/or intraday capacity calculation methodology by the concerned Core and non-Core bidding zones. In the absence of such GSK for a certain bidding zone, the default GSK shall be used for such zone, where the factors are determined in proportion to generation in the generation nodes of that bidding zone. The allocated flow pursuant to paragraph 1(b) is then calculated by multiplying all the nodal injections for allocated flow from each bidding zone with node-to-hub PTDF factors and summarising the contributions from all such nodal injections for each XNEC.

7. The nodal injections used for the calculation of loop flows and internal flows are the nodal injections calculated pursuant to paragraph 3 reduced by nodal injections for allocated flows pursuant to paragraph 6. The loop flows and internal flows are then calculated by multiplying all the nodal injections for loop flows and internal flows with node-to-hub PTDF factors and summarising the contributions from all such nodal injections as follows:

- (a) for loop flows outside the Core CCR, all contributions from non-Core bidding zones are summarised for each XNEC;
- (b) for loop flows from each bidding zone in the Core CCR, all contributions from a particular Core bidding zone are summarised for each XNEC; and Page 14 of 19
- (c) for internal flow, which is calculated only when the concerned XNE is an internal network element, all contributions from a Core bidding zone where the concerned XNE is located, are summarised for such XNEC.

8. The treatment of HVDC lines in flow decomposition shall follow the following principles:

- a) Modelling of HVDC network elements in flow decomposition shall be compatible with the virtual hub approach defined within the Core day-ahead and intraday capacity calculation methodologies.
- b) Exchanges over HVDC network element located on the bidding zone borders may be decomposed only into allocated flows on such element and other network elements impacted by it. The flow decomposition shall identify the positive injections feeding into the sending node of each such HVDC network element and negative injections supplied by the receiving node of each such HVDC network element and then model and treat such injections as other nodal injections for allocated flows in accordance with the principles described in paragraph 6 above.
- c) Exchanges over HVDC network element located within a bidding zone may be decomposed only into internal flow on such network element as well as internal and loop flows on network elements impacted by it. The flow decomposition shall identify the positive injections feeding into the sending node of each such HVDC network element and negative injections supplied by the receiving node of each such HVDC network element and then model and treat these injections as other nodal injections for loop flows and internal flows in accordance with the principles described in paragraph 7 above.

9. The calculation of flow components shall be transparent and reproducible.

10. In case the flow obtained as the sum of all flow components is not equal to the flow on an XNEC obtained with the original AC load flow, all components shall be scaled proportionally such that the sum of all components become equal to the flow on the XNEC obtained with the original AC load flow.

11. Flow decomposition shall be performed on each eligible XNEC and for each hour separately.

12. To identify the different flow components contributing to the congestions (or relieving them) and their bidding zone of origin, the flow decomposition calculation shall consider the bidding zone configuration as defined pursuant to the CACM Regulation.”

3.1 The PFC method raises procedural concerns.

414. Appellant V claims that the Contested Decision's choice for the PFC method was motivated by time pressure rather than due analysis.
415. It is factually correct that All Core TSOs were unable to submit a proposal by the date that was required by Article 74 CACM, i.e. by 17 May 2018. All Core TSOs duly informed All Core NRAs and ACER of this inability in accordance with Article 9(4) CACM and ACER duly informed the European Commission as per Article 9(4) CACM⁸². This is also set out by All Core NRAs in their Non-Paper⁸³.
416. Article 9(4) CACM reads as follows: *"If TSOs or NEMOs fail to submit a proposal for terms and conditions or methodologies to the national regulatory authorities within the deadlines defined in this Regulation, they shall provide the competent regulatory authorities and the Agency with the relevant drafts of the terms and conditions or methodologies, and explain what has prevented an agreement. The Agency shall inform the Commission and shall, in cooperation with the competent regulatory authorities, at the Commission's request, investigate the reasons for the failure and inform the Commission thereof. The Commission shall take the appropriate steps to make possible the adoption of the required terms and conditions or methodologies within four months from the receipt of the Agency's information."*
417. In accordance with Article 9(4) CACM, the European Commission took the appropriate steps to enable All Core TSOs to adopt the proposal by duly consulting with All Core TSOs, Core NRAs and ACER, and by providing its guidance to All Core TSOs⁸⁴. It is incorrect to allege that All Core TSOs' Proposal was adopted under an unreasonable time pressure. Even though, according to Article 9(4) CACM, the intervention of the European Commission should have enabled Core TSOs to adopt the proposal within 4 months from the Commission's receipt of ACER's information, it was only on 27 March 2019 that All Core TSOs submitted their RDCTCS Proposal to All Core NRAs, i.e. almost a year later than the regulatory required date⁸⁵.
418. The Board of Appeal observes that the proceedings leading-up to the Contested Decision following All Core TSOs' late submission of 27 March 2019 do not evidence a lack of due analysis or hasty analysis as regards flow decomposition. All Core TSOs' RDCTCS Proposal was accompanied by an Explanatory Document of 22 February 2019, which analysed 3 possible flow decomposition methods, namely the PFC method, the FLD method and the Multi-stage Full Line Decomposition Method ("**MFLD**")⁸⁶. All Core NRAs were given a supplementary period of 6 months to reach an agreement on All Core TSOs' RDCTCS Proposal⁸⁷. During All Core NRAs' regulatory approval proceedings, All Core TSOs were able to perform further testing and development of the RDCTCS and published an Experimentation Report on 13 March 2020 with the results of their experimentations⁸⁸. The PFC method was used in All Core TSOs' Experimentation Report⁸⁹. On 13 March 2020, Appellant V sent a letter to All Core NRAs and ACER, including a report comparing the PFC and the FLD methods⁹⁰. Following All Core NRAs' inability to agree by the extended deadline of 27 March 2020, ACER closely cooperated with All Core NRAs and TSOs and extensively consulted through teleconferences, meetings and exchanges of amendments⁹¹. During this period, discussions were held within the AEWG. During these consultations, ACER clarified the details of the applied flow decomposition methodology, including the

⁸² Contested Decision, para 5.

⁸³ Annex A.3.2 to Appeal VI.

⁸⁴ Contested Decision, para 5.

⁸⁵ Contested Decision, para 6.

⁸⁶ Contested Decision, para 6. Annex 13 to the Defence.

⁸⁷ Contested Decision, para 7.

⁸⁸ Contested Decision, para 8.

⁸⁹ All Core TSOs' Experimentation Report, Annex 23 to the Defence, p. 15.

⁹⁰ Annex 11 to Appeal V.

⁹¹ Contested Decision, paras 9-11.

definition of flow components⁹². On 30 April 2020, All Core TSOs published a Non-Paper, in which they expressed their individual positions. On flow decomposition, the majority of Core TSOs supported the use of the PFC method, whereas Appellant V, Appellant III and Intervener I supported the use of the FLD method⁹³. On 24 July 2020, ACER held a teleconference with All Core TSOs on flow decomposition⁹⁴. From 31 July 2020 until 20 August 2020, ACER held a hearing phase in which it provided All Core TSOs and NRAs with the draft amendments to All Core TSOs' RDCTCS Proposal⁹⁵. During the hearing, All Core TSOs and NRAs provided their individual comments and concerns. On flow decomposition, some TSOs and NRAs disagreed with the selection of the PFC method and the related principles, such as the treatment of HVDC flows⁹⁶. Appellant V explained its concerns in detail in its correspondence of 14 August 2020 to ACER⁹⁷. At the end of the proceedings leading-up to the Contested Decision, ACER expressly reiterated the reasons as to why it favoured the PFC method in an email of 27 October 2020 to Appellant V⁹⁸:

"You have presented these concerns to us several times and we have evaluated them thoroughly. Our opinion is that your proposed method for flow decomposition is not suitable for cost sharing methodology because it is not consistent with the zonal market model. This is most evident from the fact that it produces non-zero allocated/market flows even in the absence of any cross-zonal trade and capacity allocation. This is in our view a sufficient disqualifying reason for application of such method. While the treatment of HVDC lines is a bit more flexible, we conclude that it would be unfair for internal HVDC lines to also cause market flows and for cross-border HVDC line to also cause internal and loop flows, as these lines have been built and used purposely to facilitate internal/cross-zonal trade."

419. The Board of Appeal notes that it is not competent to rule in relation to Appellant V's argument that the European Commission exceeded its powers under Article 9(4) CACM.

420. Appellant V also argues that the Contested Decision does not duly reason the use of the PFC method. This Sub-Plea is dealt with in the Seventeenth Consolidated Plea below.

3.2 Flow decomposition in the Contested Decisions' RDCTCS.

421. Both Appellant V and ACER agree that the applicable regulatory framework requires flow decomposition. Indeed, Article 16(13) ER requires an identification of the extent to which flows resulting from transactions internal to BZs contribute to congestion. In other terms, it requires that LFs and IFs be identified.

422. Flow decomposition identifies, for each XNEC and for each hour, the different types of flows that caused the congestion for which a RA was activated.

423. The decomposed flows are AFs (market flows, i.e. import/export flows and transit flows), LFs, IFs or PST flows.

424. As has been set out in Sub-Plea 3.1 above, various flow decomposition methods exist.

425. All Core TSOs' RDCTCS Proposal was accompanied by an analysis of 3 flow decomposition methods in its Explanatory Document: the PFC method, the FLD method and the MFLD method. All Core TSOs used the PFC method in their Experimentation Report⁹⁹. All Core NRAs' Non-Paper did not address flow decomposition. All Core TSOs' Non-Paper reflected a divergence of views: the majority of Core TSOs supported the use of the PFC method, whereas Appellant V, Appellant III and Intervener I supported the use of the FLD method¹⁰⁰.

426. As set out in Sub-Plea 3.1 above and is set out in paragraph 101 of the Contested Decision, ACER consulted with All Core NRAs and TSOs and carefully analysed the PFC method and

⁹² Contested Decision, para 24(b).

⁹³ All Core TSOs' Non Paper, Annex 79 to the Defence, p.41-46.

⁹⁴ Contested Decision, para 11.

⁹⁵ Contested Decision, paras 26-29.

⁹⁶ Contested Decision, para 28(c).

⁹⁷ Annex 26 to Appeal V.

⁹⁸ Annex 63 to the Defence.

⁹⁹ All Core TSOs' Experimentation Report, Annex 23 to the Defence, p. 15.

¹⁰⁰ All Core TSOs' Non Paper, Annex 79 to the Defence, p.41-46.

FLD method. ACER concluded that the PFC method was more suitable to decompose flows in a zonal market model and is consistent with the CC process as regards the calculation of AFs.

427. ACER consequently decided to use the PFC method to decompose flows in the Contested Decision' RDCTCS.
428. The PFC method identifies, for each node in the CGM, the components causing flows in positive and negative nodal injections (sources and sinks) and converts them into different types of flows (AFs, LFs, IFs) on the basis of nodal Power Transfer Distribution Factors ("PTDFs").
429. Summarising the PFC method in a simplified manner, it uses a Generation and Load Shift Key ("GLSK") to determine nodal injections corresponding with exports/imports and nodal injections corresponding with exchanges within a BZ. Deducing the volume of injections reflecting internal exchanges ("**internal injections**") from the total volume of all nodal injections results in injections reflecting CZC exchanges ("**CZC injections**"). On the basis of PTDFs, CZC injections are converted into AFs and internal injections are converted into IFs and LFs. The method's decomposition is done per BZ in order to match the zonal market model.
430. AFs are not further decomposed because costs from AFs are distributed according to the OPP.
431. IFs and LFs are decomposed: IFs are identified when the NE in the PTDF-matrix is located in the same BZ, whereas LFs are identified when the NE in the PTDF-matrix is located on the BZB or within another BZ.
432. LFs originating outside Core CCR are not further decomposed because costs from LFs originating outside Core CCR are distributed according to the OPP. LFs originating in Core CCR are further decomposed per individual BZ because costs from LFs originating in Core CCR are distributed according to the PPP. Hence, their cause needs to be identified.

3.3 The PFC method ignores electrical distance, creates fictional flows and thereby obstructs any reasonable cost-attribution.

433. Appellant V claims that the PFC method contains systemic errors in its design and therefore falsely decomposes actually inexistent LFs and transit flows and, consequently, import/export flows and IFs. This is, in its view, especially serious because flow decomposition is at the core of the RDCTCS: it is the nexus on which the ability to attribute costs based on a flow-based PPP depends.
434. Appellant V alleges that the FLD method has to be preferred over the PFC method. It describes the FLD method as follows:

"Methodologically, the FLD approach rests on two general principles. First, its basic approach is that the decomposition of physical flows must take place on a physical level, and, in particular, be independent of the market design. This is because the market design is essentially a virtual overlay which is limited by the physical network topology. Further, only physical flows cause congestions. Consequently, the FLD operates network information as the relevant data input source which compromises topology, branch impedances, nodal injections and PST tap settings. The FLD does not rely on approximate parameters used to calculate available capacity with safety margins. In particular, there is no need to operate GSKs. In addition, for means of decomposing flows, no zonal aggregation applies. Notably, this is in line with the fact that regulation neither stops electricity flows at the respective border of a bidding-zone, nor influences the physical determination of the nodal exchanges. Thus, TenneT objects the misleading statement that "both methods" would in "general follow a two-step approach" (Decision, para. 96). Technically, only the PFC method needs to operate two models (see above). Within the FLD method, a zonal aggregation of nodal exchanges only takes place, because the TSOs agreed to share costs on a bidding-zone level, which Article 7(8) of Annex I to the Decision reflects.

Secondly, by utilizing flow-tracing, the FLD method properly considers electrical distance. The physical rationale, that is applied for flow-tracing is Bialek's Proportional Sharing Principle (PSP). According to PSP, the mutual proportion of in-flows is reflected by the components of out-flows, which essentially means that each node of the system works as a "perfect mixer". This principle is generally accepted and, based on the network topology and information on the generation and load, capable of generating accurate and reliable flow

decomposition results. Thereby, the calculations "robust and fast" and, even according to the Core TSOs' statement of 2019, provides numerous further advantages."

435. Appellant V summarizes the methodological differences between the PFC method and the FLD method as follows:

Table 1: Methodological approaches for flow decomposition		
	PFC method	FLD method
General approach	Zonal configuration	Network characteristics
Underlying physics	Superposition Principle	Flow-tracing (Proportional Sharing Principle)
Zero-balance-Approach	Yes	No
External parameters	Capacity calculation (GSK)	None
Practically proven	No	Yes (STD, TSCNET)

Source: Appeal of Appellant V, paragraph 82.

436. The Board of Appeal acknowledges that flow decomposition per XNEC is a necessary step to allow for an attribution of these XNEC-related costs to All Core TSOs, especially when cost attribution is performed on the basis of the PPP.

437. As a preliminary observation, Sub-Pleas 3.1 and 3.2 show that, from a technical point of view, there is not one uniquely valid flow decomposition method, but that various valid flow decomposition methods co-exist.

438. Appellant V's claim that the PFC method allegedly decomposes fictitious flows, as compared to the FLD method, is linked to the fact that the PFC method is based on an upfront identification of internal injections and CZC injections, which are respectively converted into IFs/LFs and AFs. The FLD method does not contain a similar upfront split between internal injections and CZC injections.

439. The Board of Appeal finds that the use of a GSK/GSLK to split internal and CZC injections and deduct AFs does not render the method, or any part of it, fictitious. The use of a GSK is a standard feature of other CACM methods in the EU, both in Core CCR and other CCRs. In effect, Article 2(12) CACM defines a GSK as a "method of translating net position change of a given bidding zone into estimated specific injection increases or decreases in the common grid model".

440. Article 21(1)(a)(iii) CACM requires the DA Core CCM and ID Core CCM to include a methodology for determining the GSK in accordance with Article 24 CACM. Article 24 CACM, entitled "Generation Shift Keys Methodology", in turn, requires the CCM to include a proposal for a methodology to determine a common GSK for each BZ and scenario, which represents the best forecast of the relation of a change in the net position of a BZ to a specific change of generation or load in the CGM. Article 9 of the DA Core CCM and Article 9 of the ID Core CCM duly contain a GSK methodology. Furthermore, in the regional calculation of CZC as per Article 29 CACM, TSOs provide the coordinated capacity calculator ("CCC") *inter alia* with GSKs, which the CCC uses to calculate the impact of changes in BZ net positions and flows on direct current lines. As set out by ACER's Defence¹⁰¹: when one BZ exports and the other BZ imports, the GSK determines for each generation node in the exporting BZ how much it exports and for each load node in the importing BZ how much it imports.

441. As set out in Sub-Pleas 1.1.2 and 1.1.3 of the First Consolidated Plea, the RDCTCS is crucial for RA coordination which interacts with CC processes in the EU zonal market model.

442. The fact that the RDCTCS operates in a zonal market model renders a correct decomposition of AFs crucial to ensure the attainment of the regulatory objectives of RA coordination and alternative CACM measures. An incorrect decomposition of AFs in the RDCTCS – which

¹⁰¹ Defence, para 346.

would either overestimate or underestimate AFs – would impede a correct interaction of the RDCTCS with alternative CACM processes.

443. As set out in Sub-Plea 1.1.7 of the First Consolidated Plea, Core TSOs are under an obligation to continuously monitor and identify the most efficient CM method for congestions on internal NEs, e.g. CC, RAs, BZ reconfiguration or network investments. An erroneous decomposition of AFs in the RDCTCS, which, as Appellant I recognises, is key for a correct cost attribution to TSOs, could distort incentives to Core TSOs and, hence, jeopardise a correct functioning of the CACM all in all in Core. This would impede an efficient CM as required by Article 16(1) ER.
444. As set out in Sub-Plea 1.1.7 of the First Consolidated Plea, CCM and CROSA need to be fully integrated as both are measures foreseen by CACM.
445. Appellant V acknowledges the consistency of the PFC method with the zonal configuration of the EU electricity market in the above-mentioned table setting out the methodological differences between the PFC method and the FLD method.
446. Contrary to Appellant V's claim, the features indicated in the said table - namely the use of a GSK, the use of the superposition principle and the zero-balance approach - are common features of similar calculation methods. The superposition principle decomposes nodal injections for AFs, based on a net position in a BZ, and nodal injections for IFs and LFs (based on a position of a BZ without commercial CB exchanges, i.e. shifting the net position of the BZ to zero)¹⁰². As Appellant V recognises, the superposition principle implies that for all linear systems the net response caused by two or more stimuli is the sum of the responses that would have been caused by each stimulus individually¹⁰³.
447. Consequently, the Board of Appeal does not find that the PFC method is based on fictitious flows and finds that the PFC method ensures consistency of RA coordination with other CACM measures within the EU zonal market design.
448. Furthermore, as evidenced by ACER's Defence, in certain circumstances, the FLD method overestimates AFs and underestimates LFs. The Defence¹⁰⁴ illustrates this with a situation whereby all BZs have no CZ trade (no imports/exports), i.e. a situation whereby no CZC has been allocated or zero AFs exist. In the absence of CZC exchange to or from other BZs, all generation nodes in each BZ only supply generation nodes in the same BZ. As a result, all BZs generate only IFs and LFs. A cost sharing method applying the FLD method would not reach the conclusion that all BZs generate only IFs and LFs. This is because the FLD method assumes that load nodes are supplied by the closest generation nodes and does not exclude the exchange of pairs between close generation and load nodes in different BZs, even when there is no CZ trade. On the basis of the assumptions of the FLD method, volumes of AFs are calculated even in the absence of CZ trade: AFs are identified even if no CZC has been allocated, which contradicts the very concept of AFs. Also, the assumption that load nodes are supplied by the closest generation nodes underestimates LFs, because their origin is not necessarily close.
449. Appellant V alleges in its Reply¹⁰⁵ that the FLD method is consistent with the zonal market model but does not demonstrate that the FLD method does not significantly underestimate LFs. ACER's Rejoinder¹⁰⁶ demonstrates that Annex 10 to Appellant V's Appeal evidences that the FLD method significantly underestimates LFs, in particular when considering the fact that the X-axis of the chart is longer by approximately 25% compared with the Y-axis. The FLD method is essentially based on electrical distance, which can only be fully applied in a

¹⁰² Defence, para 346.

¹⁰³ Appeal V, Plea 2, para 73.

¹⁰⁴ Defence, paras 339-340.

¹⁰⁵ Appellant V's Reply, paras 234-239.

¹⁰⁶ Annex 101 to ACER's Rejoinder.

nodal market model. However, if the nodal market model were to be the applicable model, there would be no LF at all, nor the need for flow composition.

450. As set out above, a correct decomposition of AFs is crucial in a zonal market model. Furthermore, a correct decomposition of LFs is also crucial in a zonal market model. As set out in the First, Sixth and Seventh Consolidated Pleas, LFs are polluting flows that are identified as the primary contributors to the congestion above a *de minimis* threshold (because LFs are unavoidable in a zonal market model).

451. The Board of Appeal consequently finds that ACER correctly assessed that the FLD method was not an appropriate flow decomposition method when adopting the Contested Decision.

3.4 The PFC method infringes Article 16(13) ER and the PPP.

452. Appellant V claims that the PFC method infringes Article 16(13) ER and the PPP because it ignores electrical distance and applies zonal aggregation in its flow decomposition, which causes fictional flows. This has the adverse effect that the entire cost attribution of Article 7 of the Contested Decision's RDCTCS is based on fictional flows.

453. In its view, the PFC method infringes Article 16(13) ER and the PPP because the PPP is based on real, physical flows and not on fictional flows. Article 16(13) ER is based on a physical flows approach contrary to a market approach based on electricity sales: fictional flows cannot cause congestions in the meaning of Article 16(13) ER. Appellant V refers to Article 2(3) and (52) ER and Article 2(12) and (34) of Directive (EU) 2019/944 ("**Electricity Directive**").

454. Article 16(13) ER reads as follows: "*When allocating costs of remedial actions between transmission system operators, regulatory authorities shall analyse to what extent flows resulting from transactions internal to bidding zones contribute to the congestion between two bidding zones observed, and allocate the costs based on the contribution to the congestion to the transmission system operators of the bidding zones creating such flows except for costs induced by flows resulting from transactions internal to bidding zones that are below the level that could be expected without structural congestion in a bidding zone. That level shall be jointly analysed and defined by all transmission system operators in a capacity calculation region for each individual bidding zone border, and shall be subject to the approval of all regulatory authorities in the capacity calculation region.*"

455. Article 2(3) of the ER defines CB flow as "*a physical flow of electricity on a transmission network of a Member States that results from the impact of the activity of producers, customers, or both, outside that Member State on its transmission network*". Article 2(52) ER refers to Article 2(34) Electricity Directive for the definition of transmission as "*transport of electricity on the extra high-voltage and high-voltage interconnected system with a view to its delivery to final customers or to distributors, but does not include supply*". Article 2(12) Electricity Directive defines "supply" as "*sale, including the resale, of electricity to customers*".

456. As set out above in Sub-Plea 3.3, the PFC method correctly identifies the physical flow components in order to allow for due cost distribution to TSOs. It is not based on fictitious flows and ensures consistency of RA coordination with other CACM measures within the EU zonal market design. Article 16(13) ER requires to identify to what extent "*flows resulting from transactions internal to bidding zones*" cause congestion, i.e. to identify internal flows (IFs and LFs) in a BZ. The PFC method correctly identifies AFs, IFs and LFs. The PFC method also correctly identifies PST flows, which are calculated with the use of phase shifter distribution factors ("**PSDFs**"). PSDFs express the impact of a change of one tap of a PST on a flow on a NE. The PST flow is determined by multiplying for each PST its tap position with the corresponding PSDF and then sum all contributions from all PSTs into a single PST flow¹⁰⁷.

457. Therefore, the PFC method contains a flow decomposition method that allows for an attribution of costs to TSOs on the basis of the PPP, where the latter principle applies, namely for LFs above the threshold. Accordingly, the PFC method ensures compliance with Article

¹⁰⁷ Contested Decision, para 100.

16(13) ER. It allows for a correct identification of the polluting flows, namely IFs and LFs. It also allows for a correct decomposition of IFs and LFs, which is a preliminary step to allow for a determination of a *de minimis* LF threshold.

458. By contrast, a decomposition of flows by means of the FLD method would not be in accordance with the PPP and not ensure compliance with Article 16(13) ER. Its overestimation of AFs has the corollary effect of reducing polluting flows (IFs and LFs), which goes counter the requirement of Article 16(13) ER to identify the causers of the congestion. Furthermore, its underestimation of LFs would not only infringe the requirement of Article 16(13) ER to identify the causers of the congestion, but would also distort the outcome of the determination of the *de minimis* LF threshold whilst also distorting a correct cost attribution of LFs to TSOs on the basis of the PPP. The incompatibility of the FLD method with the zonal market model would render it difficult to identify to what extent “flows resulting from transactions internal to bidding zones” cause congestion given that the definition of internal transactions in Article 16(13) ER depends on the concept of BZs (“internal” meaning “within the BZ”).
459. Appellant V claims that the PFC method infringes the PPP because TSOs creating inexistent, fictional LFs bear the burden of costs for RDCTs. This is, in its view, because the PFC method’s two-step superposition approach produces arbitrary results: it ignores the electrical distance between load and generators and overestimates transit flows and LFs. In a first step the amount of natural flows is determined (IFs and LFs) and in a second step the amount of AFs (import/export flow and transit flow) is determined. Appellant V claims that the PFC method implies that transit flows and LFs are decomposed even though only direct exchanges between generation and load take place (i.e. IFs and import/export flows) due to electrical distance. By ignoring the physical reality of electricity, the PFC method is, in its view, based on incorrect assumptions. Appellant V also claims that the PFC method infringes Article 16(13) ER because it is structurally incapable, due to its design, to comply with Article 16(13) ER: its design excludes physically relevant generation-to-load exchanges, which artificially increases transit flows. This contradicts the ultimate goal to determine the causation of the congestion. Appellant V illustrates this with practical examples¹⁰⁸ and All Core TSOs’ Experimentation Report¹⁰⁹.
460. As set out above, the PFC method, based on a two-step approach, is neither arbitrary nor based on incorrect assumptions. It correctly decomposes physical flows in order to allow the cost sharing solution to attribute costs to TSOs using a methodology that creates reliable results in a zonal market design.
461. On the alleged decomposition of artificially increased transit flows, such decomposition does not occur in the PFC method because it does not further decompose AFs, given that costs from AFs are distributed according to the OPP (see Sub-Plea 3.2 above).
462. Appellant V’s insistence on the fact that the FLD method is closer to physical reality does not take due account of the fact that any flow decomposition method for the RDCTCS will *per se* apply in a zonal market configuration. Assuming, *ad arguendum*, that the FLD method would be an optimal method to decompose flows in the abstract, it would still not be appropriate if, when applied to the concrete circumstances of an unavoidable zonal market configuration, its outcome proves not to be optimal.

3.5 The PFC method infringes Article 74(6)(c) CACM.

463. Article 74(6)(c) CACM requires the RDCTCS to “(c) ensure a fair distribution of costs and benefits between the TSOs involved”.

¹⁰⁸ Confidential Annex 9 and Annexes 20 and 21 to Appeal V. A non-confidential version of Annex 9 to Appeal V has been provided by Appellant V and shared among parties.

¹⁰⁹ Annex 12 to Appeal V, see also Annex 23 to the Defence.

464. According to Appellant V the PFC method ignores the physical reality of electricity and creates arbitrary outcomes, resulting in an unfair distribution of costs.
465. The Board of Appeal refers to Sub-Pleas 3.3 and 3.4, which set out that the PFC method does not create arbitrary outcomes, resulting in an unfair distribution of costs. The PFC method correctly identifies IFs and LFs, which allows for a fair distribution of costs among TSOs. The FLD method, by contrast, overestimates AFs and underestimates LFs, which, as set out above in Sub-pleas 3.3 and 3.4, distorts cost distribution among TSOs and renders such distribution unfair.

3.6 The PFC method infringes Article 74(6)(i) CACM, the principles of transparency and non-discrimination and Article 3(e) CACM.

466. Article 74(6)(i) CACM requires the RDCTCS to “(i) comply with the principles of transparency and non-discrimination.”
467. Article 3(e) CACM contains the CACM objective of “ensuring fair and non-discriminatory treatment of TSOs, NEMOs, the Agency, regulatory authorities and market participants”.
468. Appellant V claims that, due to the zonal approach, the PFC method treats physically identical situations differently, depending on the zonal configuration, which results in a discrimination between TSOs.
469. The identification of “flows resulting from transactions internal to bidding zones” that cause congestion, required by Article 16(13) ER, depends on the concept of BZ (“internal” meaning “within the BZ”). The identification of flows components per BZ, performed by the PFC method, is therefore necessary to ensure compliance with Article 16(13) ER. Also, consistency with the zonal model ensures that costs are distributed in a fair and non-discriminatory manner among Core TSOs.
470. By contrast, the distortions created by the FLD method as regards cost distribution, due to its incompatibility with the zonal market model, would discriminate between Core TSOs.

3.7 The PFC method infringes Article 74(6)(a) CACM.

471. Article 74(6)(a) CACM requires the RDCTCS to “(a) provide incentives to manage congestion, including remedial actions and incentives to invest effectively”.
472. Appellant V claims that the PFC method does not provide TSOs with incentives to invest or optimise their network because (i) it generates arbitrary results, which are structurally incapable of providing any incentive and (ii) it structurally ignores the network configuration and relevant generation-to-load exchanges.
473. As set above in Sub-Pleas 3.3 to 3.6, the PFC method does not create arbitrary results but correctly decomposes flows in accordance with Article 16(13) ER. It accordingly enables cost distribution down the line to comply with the cost sharing principles of the RDCTCS. By enabling a correct identification of LFs, the PFC method allows for a penalisation of primary contributors to the congestion, i.e. LFs above the threshold, in accordance with the PPP. A correct application of the PPP, in turn, provides the correct incentives to the LF causing TSOs so that they take the necessary measures to reduce LFs below the threshold.
474. By contrast, the overestimation of AFs and underestimation of LFs that the FLD method triggers in a zonal market model distorts the cost distribution outcome and, consequently, fails to provide the correct incentives to Core TSOs.

3.8 The PFC method infringes Article 74(5)(d) CACM.

475. Article 74(5)(d) CACM requires the RDCTCS to include “(d) a process allowing improvement of the remedial actions”.
476. Appellant V claims that the PFC method does not allow for the improvement of RAs.
477. As set out in Sub-Plea 1.1.3 of the First Consolidated Plea, a coordinated cost sharing solution is key to regional XRA coordination. The chosen flow decomposition method does not, however, impede the RDCTCS to include a process allowing improvement of RAs. Article

74(5)(d) CACM is therefore not relevant to the choice of the decomposition method. Furthermore, the Contested Decision's RDCTCS contains a review clause in Article 12, which provides that Core TSOs shall perform an annual review of the cost sharing methodology to identify possible improvements of the cost sharing methodology in terms of meeting its objective and purposes, effectiveness, efficiency and quality of cost estimations.

3.9 The PFC method infringes Article 74(6)(e) CACM.

478. Article 74(6)(e) CACM requires the RDCTCS to “(e) facilitate the efficient long-term development and operation of the pan-European interconnected system and the efficient operation of the pan-European electricity market”.
479. Appellant V claims that the decision does not facilitate efficient long-term development and operation of the pan-European interconnected system.
480. As set out above in Sub-Pleas 3.3 to 3.8, flow decomposition according to the PFC method provides a reliable outcome in a zonal market configuration, whereas flow decomposition according to the FLD method does not provide a reliable outcome but a distorted outcome in a zonal market model.
481. In the absence of distortions, the PFC method ensures, contrary to the FLD method, a fair and non-discriminatory XRA cost sharing solution that provides the correct incentives and economic signals to Core TSOs. This will ensure an efficient long-term development and operation of the pan-European interconnected system and efficient operation of the pan-European electricity market, given that the EU market is based on a zonal model design. As set out above in Sub-Plea 3.3, a correct decomposition of AFs and LFs is crucial in a zonal market model. A RDCTCS that provides a reliable outcome in a zonal model is, in turn, key to ensure the attainment of the regulatory objectives of RA coordination and alternative CACM measures.

3.10 The PFC method infringes Article 74(6)(g) CACM.

482. Article 74(6)(g) CACM requires the RDCTCS to “(g) allow reasonable financial planning”.
483. Appellant V claims that the PFC method does not enable TSOs to conduct a reasonable financial planning.
484. As set out above in Sub-Pleas 3.3 to 3.8, flow decomposition according to the PFC method provides a reliable outcome in a zonal market configuration, whereas flow decomposition according to the FLD method does not provide a reliable outcome but a distorted outcome in a zonal market model. The absence of distortions allows for a reasonable financial planning.

3.11 The PFC method infringes the objectives of the ER, the Electricity Directive and the objectives of Recitals (1) and (3) and Articles 3 and 74 CACM.

485. Appellant V claims that ACER erroneously justifies the PFC method on the basis of consistency with the zonal market model and capacity calculation, which does not justify false flow results. Appellant V opposes ACER's reasoning in paragraph 101 of the Contested Decision.
486. Paragraph 101 of the Contested Decision states: “*In the Experimentation report, Core TSOs were using the power flow colouring (PFC) method as the basis for the flow decomposition, since its representation of flow components is better reflecting the nature of the zonal European market model and provides more intuitive results. Thus, the majority of Core TSOs and regulatory authorities proposed to use this method for power flow decomposition. ACER carefully analysed both methods and consulted also with TSOs and regulatory authorities, which supported the full line decomposition method. Nevertheless, based on all the information gathered, ACER concluded that power flow colouring is more suitable for the zonal market model and is consistent with the capacity calculation when calculating allocated flows, which is not the case for the full line decomposition method. For this reason ACER included in the cost sharing methodology the flow decomposition based on power flow colouring.*”

487. Appellant V claims that it is incorrect that the PFC method “*better reflects the nature*” of the market model or provides more intuitive results. This does not appear in All Core TSOs’ Experimentation Report.
488. As set out above in Sub-Plea 3.1, the PFC method was used in All Core TSOs’ Experimentation Report. The Experimentation Report stated that the PFC method “*considers geographical proximity on the zonal level in order to determine market flows (exports/imports and transits)*”¹¹⁰. The Experimentation Report referred to the Explanatory Document accompanying All Core TSOs’ RDCTCS Proposal for a better understanding of the PFC method. This Explanatory Document stated that “*The Power Flow Colouring (PFC) method for the decomposition of flows has been developed with the main goal to stay consistent with the European zonal market model and, at the same time, to allow for a complete partitioning of the power flow for each network element of the power system*” and “*PFC – main characteristics The main features of methodology include:*
4. *Usage of the physical reality (network model);*
 5. *Consideration of European zonal market model and linkage with the market coupling and capacity calculation;*
 6. *Consideration of the proportional and/or perfect-mixer sharing principle for exchange model as it is in general not possible to uniquely allocate origin of the source/sink exchanges to the particular nodes (proportional share split 50/50 between export and import zones);*
 7. *Calculation is independent of slack bus location;*
 8. *Both partial flows identified, relieving and burdening ones;*
 9. *Consideration of losses by using AC load flow approximation method;*
 10. *Automatic determination of a partial flows over any network element:*
 11. *In the base case without any outage*
 12. *In the contingency case with an outage*
 13. *Determination of PST influence on the total flow.*
- By the application of the PFC decomposition method, it is ensured that: 1. Total flow over an element is a sum of all partial flows, both relieving and burdening ones; 2. Total flow is decomposed into internal flow, loop flow, export/import flow and transit flows (according to ENTSO-E definition)”*¹¹¹. (emphasis added)
489. Subsequently, All Core TSOs published a Non-Paper, in which the majority of Core TSOs supported the use of the PFC method, whereas Appellant V, Appellant III and Intervener I supported the use of the FLD method¹¹².
490. Appellant V claims that consistency with the zonal market model and CCM does not justify physically unrealistic results and is not required by Article 74 CACM. Article 74(6)(h) CACM only requires “*compatibility across the DA and ID market timeframes*”. Article 74(4)(a) and (b) CACM only require, in its view, a determination of which costs are taken into account in accordance with the CCM.
491. The Board of Appeal refers to Sub-Pleas 3.2 and 3.3 above, as well as 3.12 below, which set out that the PFC method ensures a reliable outcome in the zonal market model and that the compatibility with the zonal market model is necessary to avoid distortions when applying the PPP in the ensuing cost distribution process.
492. Appellant V adds that the PFC method undermines the EU internal energy market associated with the zonal market model. This is because, in its view, the PFC method artificially forces flows to take place only between net importing and net exporting zones, which does not allow electricity to flow freely across the EU. The restriction of HVDC lines only to a certain type of flows also hinders the achievement of an EU internal energy market. This infringes, in its opinion, the objectives of the ER, the Electricity Directive and the objectives of Recitals (1) and (3) and Articles 3 and 74(4) CACM, aimed at promoting further integration of the EU internal energy market.
493. Appellant V is correct in stating that electricity should flow freely across the EU. However, electricity flows across the EU are conditioned by the zonal market design. Article 16(13) ER requires cost sharing solutions in regional XRA coordination to be compatible with the zonal

¹¹⁰ Annex 23 to the Defence, p. 15.

¹¹¹ Annex 13 to the Defence, p. 7-10.

¹¹² All Core TSOs’ Non Paper, Annex 79 to the Defence, p.41-46.

market design, as set out above in Sub-Pleas 3.3 and 3.4. The PFC method clearly ensures compliance with the objectives of Article 3 CACM and Recitals (1) and (3) CACM.

494. Article 74(4) CACM states that the RDCTCS shall “at least: (a) determine which costs incurred from using remedial actions, for which costs have been considered in the capacity calculation and where a common framework on the use of such actions has been established, are eligible for sharing between all the TSOs of a capacity calculation region in accordance with the capacity calculation methodology set out in Articles 20 and 21; (b) define which costs incurred from using redispatching or countertrading to guarantee the firmness of cross-zonal capacity are eligible for sharing between all the TSOs of a capacity calculation region in accordance with the capacity calculation methodology set out in Articles 20 and 21; (c) set rules for region-wide cost sharing as determined in accordance with points (a) and (b)”.
495. As set out in Sub-Plea 1.7 of the First Consolidated Plea, as well as Sub-Plea 3.3 above and 3.12 below, the CCM and the RDCTCS interact and a lack of compatibility between these methodologies would distort CACM all in all in Core CCR.

3.12 The PFC method infringes Article 74(6)(d) CACM.

496. Article 74(6)(d) CACM requires the RDCTCS to “be consistent with other related mechanisms, including at least: (i) the methodology for sharing congestion income set out in Article 73; (ii) the inter-TSO compensation mechanism, as set out in Article 13 of Regulation (EC) No 714/2009 and Commission Regulation (EU) No 838/2010 (1)”.
497. Appellant V claims that Article 74(6)(d) CACM’s wording “at least” implies that consistency is needed with other methodologies, especially since Article 76(1)(b)(v) SO states that it “complements” the RDCTCS. In its view, the PFC method is not consistent with the cost sharing mechanism for costs resulting from multilateral RAs in accordance with Article 76(1)(b)(v) SO. Appellant V claims that the FLD’s predecessor, the Simple Tie-Line Decomposition method (“STD”) was developed on the basis of Article 76(1)(b)(v) SO. Appellant V also claims that the multilateral RA cannot switch to the PFC method because this would infringe Article 74(5)(a) and (c) CACM. Appellant V claims that, because of the fact that the PFC method ignores electrical distance in physical generation-to-load exchanges, which are highly relevant to safeguarding OS, the PFC method does not comply with these requirements.
498. Multilateral RAs, developed on a voluntary basis, fall foul of the SO. Appellant V refers to the voluntary Multilateral Remedial Action Agreement (“MRA Agreement”)¹¹³, aimed at ensuring network security between 14 (Core and non-Core) TSOs under the umbrella of Regional Security Coordinator (“RSC”) TSCNET GmbH¹¹⁴ following regulatory approval. The MRA Agreement has not been adopted by All Core TSOs. It is neither covered by Article 76(1)(b)(v) SO nor by Core ROSC. Even if, *ad arguendum*, the STD method were to be a flow decomposition method – which both the Defendant and Appellant I challenge¹¹⁵ - the CACM does not require the RDCTCS to ensure consistency with the STD method, used by the MRA Agreement.
499. Article 74(5)(a) CACM requires the RDCTCS to include “a mechanism to verify the actual need for RDCT between the TSOs involved”.
500. Article 74(5)(c) CACM requires the RDCTCS to include “a mechanism to assess the impact of the remedial actions, based on operational security and economic criteria”.
501. The requirements of Article 74(5)(a) and (c) CACM relate to the effectiveness of RAs. The choice of the flow decomposition method (PFC method or FLD method) does not have an impact on whether the coordinated RAs were sufficiently effective to relieve physical

¹¹³ See MRA FAQ, Annex 77 to the Defence.

¹¹⁴ <https://www.tscnet.eu/>.

¹¹⁵ In its Reply to the Board of Appeal’s Second Request for Information, the Defendant viewed that the STD method relates to tie-lines only, does not decompose physical flows, does not identify IFs or LFs and does not use any load flow of CGM. Appellant I informed that the STD method is aimed at penalising unscheduled flows resulting mainly from uncoordinated NTC-based capacity allocation and is a zonal model (as opposed to a nodal model like the FLD method).

congestions. Flow decomposition methods relate to the costs generated by the chosen RAs but not to the effectiveness of the chosen RAs.

502. The Board of Appeal finds, moreover, as set out above in Sub-Pleas 3.3 and 3.4, that the PFC method ensures a correct decomposition of flows in a zonal market configuration and is consistent with the EU zonal market design, whereas the FLD method fails to do so. In accordance with Article 74(6)(d) CACM, the PFC method therefore ensures consistency with the methodologies that require an identification of AFs with the use of a GSK, namely the DA Core CCM and ID Core CCM (Article 20 CACM) and the CIDM (Article 73 CACM).
503. The FLC method is not consistent with these methodologies.
504. The Board of Appeal notes that the PFC method is also consistent with the requirements of Article 16(8) ER regarding the minimum margin available (minRAM) for CZ trade. According to the CC process, Core TSOs calculate the minRAM and the 30% margin for LFs, IFs and a reliability margin on the basis of a GSK. Compatibility with this requirement would be problematic if TSOs were to use a flow decomposition method that does not use a GSK to decompose LFs, IFs and AFs in the RDCTCS.
505. The FLC method is not consistent with the requirement of Article 16(8) ER.
506. Appellant V claims that Article 74(6)(d) CACM expressly refers to consistency with the ITC and that the PFC method is not consistent with the ITC set out in Article 49 ER and Commission Regulation (EU) 838/2010. In its view, the PFC method seeks consistency with electricity sales, whereas the ITC compensates for the physical utilization of foreign networks (requiring maintenance investments), unaffected by electricity sales.
507. Article 49(1) and (2) ER state:
- “1. Transmission system operators shall receive compensation for costs incurred as a result of hosting cross-border flows of electricity on their networks.*
- 2. The compensation referred to in paragraph 1 shall be paid by the operators of national transmission systems from which cross-border flows originate and the systems where those flows end.”*
508. Appellant V refers to Article 49(5) ER: *“The magnitude of cross-border flows hosted and the magnitude of cross-border flows designated as originating or ending in national transmission systems shall be determined on the basis of the **physical flows** of electricity actually measured during a given period.”* (emphasis added)
509. First, as has been set out above in Sub-Pleas 3.3 to 3.12, the PFC method ensures compliance with Articles 74 CACM and 16 ER.
510. Second, the ER contains an explicit description of ITC’s compensation mechanism, as per Article 49(5) ER, whereas neither the CACM nor the ER expressly describes the flow decomposition method.
511. Third, the requirement of consistency of the RDCTCS with the ITC does not imply that the RDCTCS should follow all methodological steps of the ITC, because both procedures pursue different goals and have a different legal basis. The ITC is not a regional cost sharing methodology following a bottom-up, multipartite decision-making process but an EU-wide mechanism to compensate costs incurred by TSOs as a result of hosting CB flows of electricity on their networks based on Article 49 ER of Chapter V *“Transmission System Operation”* of the ER. The Contested Decision’s RDCTCS is a methodology to share costs of XRAs following a regionally coordinated identification of costly XRAs to solve physical congestion at Core level, based on Article 74 of Chapter II *“Redispatching and countertrading cost sharing methodology for single day-ahead and intraday coupling”* of the CACM, adopted following a bottom-up, multipartite decision-making process.
512. All TSOs in the EU need to compensate each other when they use each other’s network on the basis of periodical measurements of physical flows of electricity according to the ITC. The RDCTCS is not a compensation mechanism but a regional cost sharing methodology following a coordination of costly XRAs to solve physical congestion. There is a conceptual difference between a compensation mechanism and a regional cost sharing methodology, as both pursue different goals. On the one hand, the ITC compensates for the fact that a TSO was unable to fully use its network when hosting CB flows originating from another TSO,

regardless of congestions. On the other hand, the RDCTCS is a cost sharing solution for costly XRAs pursuant to congestions: it aims at providing correct incentives to manage congestion, being consistent with the responsibilities and liabilities of the TSOs involved in the region, ensuring a fair distribution of costs and benefits between the TSOs of the region, facilitating efficient long-term development and operation of the EU interconnected system and the efficient operation of the EU electricity market, facilitating adherence to the general principles of CM of Article 16 ER (*inter alia* taking account of the effect of the RDCTCS on neighbouring control areas and coordinating such measures with other TSOs and complying with the PPP), allowing reasonable financial planning, being compatible across DA and ID market-timeframes and complying with the principles of transparency and non-discrimination.

3.13 The use of a CC GSK differs from the use of GSK for flow decomposition.

513. Appellant V opposes the use of the GSK - used to define how a change in net position is reflected in the output of every generating unit inside the same BZ - as defined in Article 2(12) CACM: “a method of translating a net position change of a given bidding zone into estimated specific injection increases or decreases in the common grid model”.
514. Appellant V claims that the GSK is a parameter from CCM (ACER Decision 02/2019) and cannot be used for flow decomposition. Appellant V refers to paragraph 102 of the Contested Decision:
“Some Core TSOs and NRAs expressed concerns that the generation shift key used in capacity calculation is not appropriate for the flow decomposition for importing bidding zones (i.e. bidding zones that import electricity in a specific hour). This is because the generation shift key used in capacity calculation models the import of electricity as reduction of generation in such zone, whereas in flow decomposition the import of electricity is proposed to be modelled as increase of consumption in such bidding zone. Therefore, flow decomposition with the generation shift key from capacity calculation would artificially increase the internal exchanges in such bidding zones (which are calculated in the absence of electricity imports) and thereby increase loop flows and internal flows. ACER agrees with these concerns and suggested that the concerned TSOs try to harmonise generation shift key methodology between capacity calculation and flow decomposition such that the same assumptions about imports of electricity are made in both areas. This is needed to ensure that the flow components calculated during capacity calculation are aligned as much as possible with the flow components calculated during cost sharing. With this regard, the generation shift key method defined in capacity calculation methodologies should be flexible enough to accommodate this consistent approach.”
515. In Appellant V’s view, the GSK of CCM is not appropriate for flow decomposition because it is not necessary and does not provide accurate results after market coupling. First, Appellant V claims that the GSK is not compatible with the purpose of flow decomposition because it is based on the two-days-ahead (“D2CF”) network model. It is a multidimensional model, in which all possible flows over all critical branches are taken into account, while simultaneously simulating all possible net configurations, by contrast to the flow decomposition process, which assesses a specific operational point (either based on the DACF or on the IDCF). In Appellant V’s view, it is not correct to assume that a generator contributes either to the (commercial) net import or net export position. In its opinion, the net position is the sum of all commercial exchanges per BZB, which can physically be exporting for one BZB and importing for another BZB.
516. The Board of Appeal refers to Sub-Pleas 3.3 and 3.4 above, which evidence that consistency of the RDCTCS and the CCM processes is key to an efficient CACM within the EU’s zonal market configuration.
517. Article 4(1)(f) of the Contested Decision’s RDCTCS foresees that the GSK used in the application of the Core DA and ID Core CCM is an input to the RDCTCS.
518. Article 6 of the Contested Decision’s RDCTCS on flow decomposition reads as follows: “The nodal injections for allocated flows are calculated by multiplying the net positions contained within the CGM, with the factors contained within the GSK that is used in the application of dayahead capacity calculation methodology and/or intraday capacity calculation methodology by the concerned Core and non-Core bidding zones. In the absence of such GSK for a certain bidding zone, the default GSK shall be used for such zone, where the factors are determined in proportion to generation in the generation nodes of that bidding zone. The allocated flow pursuant to paragraph 1(b) is then calculated by multiplying all the nodal injections for allocated

flow from each bidding zone with node-to-hub PTDF factors and summarising the contributions from all such nodal injections for each XNEC.”

519. Neither the Contested Decision nor the DA Core CCM/ID Core CCM contains requirements on the use by Core TSOs of the GSK. The only requirement is that the GSK that is used for flow decomposition under the RDCTCS is consistent with the GSK that is used for CCM, in accordance with Article 74(6)(d) and (h) CACM. This is set out in paragraph 102 of the Contested Decision: “*ACER agrees with these concerns and suggested that the concerned TSOs try to **harmonise generation shift key methodology** between capacity calculation and flow decomposition such that the same assumptions about imports of electricity are made in both areas. This is needed to ensure that the flow components calculated during capacity calculation are **aligned as much as possible** with the flow components calculated during cost sharing. With this regard, the generation shift key method defined in capacity calculation methodologies should be **flexible enough to accommodate this consistent approach.**” (emphasis added)*
520. The CCM GSK is compatible with the aim of flow decomposition. In both the CCM and the RDCTCS, the GSK is used to calculate the effects of CA on physical flows, namely to calculate how the net positions of the BZs reflect on the physical flows.
521. The consistency between the CCM GSK and the RDCTCS GSK is not only appropriate, but indispensable to ensure consistency between the CCM and the RDCTCS, which is, in turn, indispensable to the overall functioning of the CACM in the EU market. The GSK allows the PFC method to carry out an upfront split between CZC injections and internal injections, which prevents divergences in AFs between the RDCTCS and the CCM.

3.14 The use of a GSK violates Article 16(13) ER.

522. Appellant V holds that the use of GSK creates a deviation from the physical reality, which infringes Article 16(13) ER. Appellant V claims that the use of the GSK will therefore result in physically inexistent flows, which impedes the determination of the cause of the congestion based on physical flows in accordance with Article 16(13) ER. In its view, paragraph 102 of the Contested Decision confirms this.
523. The use of the GSK is compliant with Article 16(13) ER. Similarly to the PFC method as a whole, the use of the GSK within the PFC method allows for an attribution of costs to TSOs on the basis of the PPP (see Sub-Plea 3.3). It allows for an upfront split between internal injections and CZC injections, that are subsequently converted into respectively IFs/LFs and AFs. By enabling this split, the GSK allows the PFC method to identify the polluting flows, namely IFs and LFs. The GSK ensures the identification to what extent “*flows resulting from transactions internal to bidding zones*” cause congestion, i.e. to identify internal flows (IFs and LFs) in a BZ, in accordance with Article 16(13) ER.
524. By contrast, the FLD method does not ensure compliance with Article 16(13) ER and allow for a correct application of the PPP as it overestimates AFs and reduces IFs and LFs, which goes counter the requirement of Article 16(13) ER to identify the causers of the congestion. It also underestimates LFs. This hampers the identification of the causers of the congestion. It also distorts the outcome of the determination of the *de minimis* LF threshold. It furthermore distorts a correct cost attribution of LFs to TSOs on the basis of the PPP. The incompatibility of the FLD method with the zonal market model would render it difficult to identify to what extent “*flows resulting from transactions internal to bidding zones*” cause congestion given that the definition of internal transactions in Article 16(13) ER depends on the concept of BZs (“internal” meaning “within the BZ”).
525. Both the PFC method with a GSK and the FLC method without a GSK ensure that the sum of all flows (i.e. the total flow or physical flow) corresponds with the physical reality. As set out above in Sub-plea 3.4, Appellant V’s insistence on the fact that the use of a GSK does not match the physical reality does not take due account of the fact that any flow decomposition method for the RDCTCS will *per se* apply in a zonal market configuration. Assuming, *ad arguendum*, that the FLD method would be an optimal method to decompose flows in the

abstract, it would still not be appropriate if, when applied to the concrete circumstances of an unavoidable zonal market configuration, its outcome proves not to be optimal.

526. In addition, the Core CCR uses a flow-based approach in CCM, whereby energy exchanges between BZs are limited by PTDFs and available margins on CNECs (Article 2(9) CACM). In a flow-based approach, the net positions are the direct result of the capacity allocation process, not of bilateral exchanges on BZBs. The upfront calculation of AFs through a GSK in the PFC method consequently ensures consistency with the EU's zonal market model and the Core CCR's flow-based approach in the CCM.

3.15 ACER erroneously requests TSOs to adjust the CC GSK in order to mitigate its effects in the flow decomposition process.

527. Appellant V refers to paragraph 102 of the Contested Decision.

528. Appellant V opposes the fact that TSOs request to adjust the GSK in the CCM – where a network model is used, for which it was originally designed for – in order to mitigate effects in the flow decomposition process – where a network model is used, for which it was not designed to be applied - . In its view, TSOs may only seek to optimise GSKs to maximise the available capacity, in order not to infringe Article 16(4) ER.

529. Article 16(4) ER reads as follows: “4. *The maximum level of capacity of the interconnections and the transmission networks affected by cross-border capacity shall be made available to market participants complying with the safety standards of secure network operation. Counter-trading and redispatch, including cross-border redispatch, shall be used to maximise available capacities to reach the minimum capacity provided for in paragraph 8. A coordinated and non-discriminatory process for cross-border remedial actions shall be applied to enable such maximisation, following the implementation of a redispatching and counter-trading cost-sharing methodology.*

530. Appellant V's statement that “TSOs may only seek to optimise GSKs to maximise the available capacity” is erroneous. For obvious reasons of OS, TSOs may not optimise GSKs to maximise CZC, as this could create artificial flows in order to attain higher CZC and endanger OS. TSOs need to determine the GSK in a way that maximises the correct determination of flows resulting from CA whilst ensuring that these flows meet OS standards. Both the CCM and the RDCTCS contain mechanisms to avoid this conduct and secure OS.

531. In the DA Core CCM (Annex I to ACER Decision 02/2019), Article 9 states:

“1. *Each Core TSO shall define for its bidding zone and for each DA CC MTU a **GSK, which translates a change in a bidding zone net position into a specific change of injection or withdrawal in the CGM.** A GSK shall have **fixed values**, which means that the relative contribution of generation of load to the change in the biddings zone net position shall remain the same, regardless of the volume of the change.*

2. ***For a given DA CC MTU**, the GSK shall only include actual generation and/or load present in the CGM for that DA CC MTU. The Core TSOs shall take into account the available information on generation or load available in the CGM in order to select the nodes that will contribute to the GSK.*

3. *The GSKs shall **describe the expected response of generation and /or load units to changes in the net positions.** This expectation shall be based on the **observed historical response** of generation and/or load units to changes in net positions, **clearing prices** and **other fundamental factors**, thereby contributing to minimising the FRM.*

4. *The **GSKs shall be updated and reviewed on a daily basis or whenever the expectations referred to in paragraph 3 change.** The Core TSOs shall review and update the application of the generation shift key methodology in accordance with Article 24.” (emphasis added)*

532. In the ID Core CCM (Annex II to ACER Decision 02/2019), Article 9 states:

“1. *Each Core TSO shall define for its bidding zone and for each ID CC MTU a **GSK, which translates a change in a bidding zone net position into a specific change of injection or withdrawal in the CGM.** A GSK shall have **fixed values**, which means that the relative contribution of generation of load to the change in the biddings zone net position shall remain the same, regardless of the volume of the change.*

2. ***For a given ID CC MTU**, the GSK shall only include actual generation and/or load present in the CGM for that ID CC MTU. The Core TSOs shall take into account the available information on generation or load available in the CGM in order to select the nodes that will contribute to the GSK.*

3. *The GSKs shall **describe the expected response of generation and /or load units to changes in the net positions.** This expectation shall be based on the **observed historical response** of generation and/or load units to changes in net positions, **clearing prices** and **other fundamental factors**, thereby contributing to minimising the FRM.*

4. The GSKs shall be updated and reviewed on a daily basis or whenever the expectations referred to in paragraph 3 change. The Core TSOs shall review and update the application of the generation shift key methodology in accordance with Article 22.” (emphasis added)

533. Article 10(2) of the Contested Decision’s RDCTCS states: “All Core TSOs shall monitor the forecasting accuracy of network topology, generation and load in the individual grid models that are used for cost sharing and in particular the settings of PST tap positions. In case one or more Core TSOs identify or suspect abusive behaviour (such as systematic forecast errors) or other negative impact of such forecasting, all Core TSOs shall further investigate whether the concerned TSO has gained any financial advantage from such behaviour.” (emphasis added)
534. Paragraph 102 of the Contested Decision sets out that Core TSOs are allowed to tailor the GSK of the Contested Decision’s RDCTCS to their needs, in order to avoid *ex ante* any possible negative impact, as long as it is consistent with the GSK that is used in the CCM and does not negatively impact the accuracy of the CC process. For example, Core TSOs that expect that a BZ will import may use a GSK that only includes load nodes. In so doing, Core TSOs of importing zones could ensure that only the load nodes are considered when calculating the AFs. However, optimising the GSK to maximise the available CZC would infringe the OS requirements of the applicable regulatory framework. Adequate processes have been put in place to avoid that TSOs adopt such behaviour.

3.16 The use of a GSK violates Article 74(3) CACM and Article 74(6)(c) and (i) CACM.

535. Appellant V furthermore claims that GSKs are not harmonised and different GSKs lead to different flow decomposition results, but GSK-optimisation for flow decomposition would be contrary to GSK in the CCM. Appellant V adds that the fact that GSKs are not harmonised between TSOs but under on-going scientific discussion with regard to maximisation of capacity implies that (i) the costs are not determined in a transparent and auditable manner; (ii) there is no fair distribution of costs and (iii) the use of GSKs does not comply with the principles of transparency and non-discrimination. Appellant V refers to its presentation, not or represented of the BoR granted a favourable opinion to the new draft RDCTCS Decision Annex 24 to its Appeal.
536. Article 74(3) CACM requires the RDCT costs eligible for RDCTCS “between relevant TSOs shall be determined in a transparent and auditable manner.”
537. Article 74(6)(c) CACM requires the RDCTCS “(c) ensure a fair distribution of costs and benefits between the TSOs involved”.
538. Article 74(6)(i) CACM requires the RDCTCS to “(i) comply with the principles of transparency and non-discrimination.”
539. First, as set out in Sub-Plea 3.13 above, the consistency between the CCM GSK and the RDCTCS GSK is not only appropriate, but indispensable to ensure consistency between the CCM and the RDCTCS, which is, in turn, indispensable to the overall functioning of the CACM in the EU market. The GSK allows the PFC method to carry out an upfront split between CZC injections and internal injections, which prevents divergences in AFs between the RDCTCS and the CCM.
540. Second, the CC GSK is determined in a transparent and auditable manner and complies with the principles of transparency and non-discrimination. In accordance with Article 24 CACM, Article 9 of the DA Core CCM and Article 9 of the ID Core CCM contain a transparent and non-discriminatory methodology to determine a common GSK for each BZ and scenario, duly reflecting a change in the net position of a BZ to a specific change of generation or load in the CGM. As set out above in Sub-plea 3.15, the CC GSK is audited. Article 9(4) of the DA Core CCM and Article 9(4) of the ID Core CCM foresee that the CC GSK is updated and reviewed on a daily basis or whenever there is a change in the expected response of generation and/or load units to changes in the net positions. Article 9(6) of the DA Core CCM and Article 9(6) of the ID Core CCM require All Core TSOs to further harmonise the GSK methodology when they amend the DA/ID Core CCM. It requires that the harmonised GSK methodology includes “(a) the criteria and metrics for defining the efficiency and performance of GSKs and allowing for

quantitative comparison of different GSKs; and (b) a harmonised generation shift key methodology combined with, where necessary, rules and criteria for TSOs to deviate from the harmonised generation shift key methodology.”

541. Third, regarding Appellant V’s power point presentation of 1 August 2021, attached as Annex 23 to its appeal, the Board of Appeal agrees with the correct statements that (i) a different GSK will lead to a different flow decomposition; and (ii) TSOs can develop strategies for optimising their GSK (the Board of Appeal adds that this should be done in accordance with the regulatory applicable framework, as set out above in Sub-plea 3.15). Regarding Appellant V’s extract of the Future Flow Report of private consultancy Electricity Coordinating Centre EKC of 23 December 2016, joined as Annex 24 to its appeal, stating “*Depending on GSK method chosen (proportionally to generation, proportionally to load, proportionally to reserve, proportionally to predefined coefficients or merit order list) different loop flow and therefore exchange flow results can be expected.*”, the Board of Appeal observes that the report reiterates the correct statement that a different GSK leads to a different flow decomposition.
542. Fourth, as part of the PFC method, the RDCTCS GSK is determined in a transparent and auditable manner and complies with the principles of transparency and non-discrimination. As set out above in Sub-Pleas 3.3 to 3.8, flow decomposition according to the PFC method provides a reliable outcome in a zonal market configuration, whereas flow decomposition according to the FLD method does not provide a reliable outcome but a distorted outcome in a zonal market model. The use of the GSK in the PFC method correctly identifies IFs and LFs, which (i) ensures a fair and non-discriminatory XRA cost sharing solution that provides the correct incentives and economic signals to Core TSOs, (ii) allows for a fair distribution of costs among TSOs. The FLD method, by contrast, overestimates AFs and underestimates LFs, which, as set out above in Sub-pleas 3.3 and 3.4, distorts cost distribution among TSOs and renders such distribution unfair and discriminatory in a zonal market model. Finally, the use of the GSK is determined in an auditable and transparent manner. Article 10 of the Contested Decision’s RDCTCS contains a monitoring mechanism. Article 11 of the Contested Decision’s RDCTCS requires All Core TSOs to duly report to Core NRAs and ACER. Article 12 of the Contested Decision’s RDCTCS contains an annual review mechanism to identify possible improvements.
543. Finally, paragraph 102 of the Contested Decision sets out that Core TSOs are allowed to tailor the GSK of the Contested Decision’s RDCTCS to their needs, in order to avoid *ex ante* any possible negative impact, as long as it is consistent with the GSK that is used in the CCM and does not negatively impact the accuracy of the CC process. For example, Core TSOs that expect that a BZ will import may use a GSK that only includes load nodes. In so doing, Core TSOs of importing zones could ensure that only the load nodes are considered when calculating the AFs. However, as noted by ACER’s Defence, TSOs do not have an infinite margin of discretion when defining the GSK, as an inadequate GSK will penalise TSOs with unexpected physical flows in reality which will lead to unexpected OS violations¹¹⁶. “*The more accurate GSK is “rewarded” by observing physical flows that are very close to those calculated by the capacity calculation*”¹¹⁷. These consequences minimise *per se* potential abusive behaviour in relation to the GSK. Moreover, as set out above in Sub-Plea 3.15, optimising the GSK to maximise the available CZC would infringe the OS requirements of the applicable regulatory framework. Adequate processes have been put in place to avoid that TSOs adopt such behaviour.

3.17 The use of GSK violates Article 43 et ss Electricity Directive on ownership unbundling.

544. Appellant V claims that the use of GSK establishes a direct tie between generation, electricity sales (net positions) and the (assumed) use of transmission networks. Appellant V alleges that, by contrast, according to Article 67 of the Electricity Directive, “*an effective separation of*

¹¹⁶ Defence, para 375.

¹¹⁷ Defence, para 375.

networks from activities of generation and supply” (effective unbundling) shall be applied to address inherent risks of discrimination and to allow for the promotion of efficient and non-discriminatory investments by TSOs.

545. Appellant V also refers to Recitals (67) and (68) of the Electricity Directive:

“(67) Without the effective separation of networks from activities of generation and supply (effective unbundling), there is an inherent risk of discrimination not only in the operation of the network but also in the incentives for vertically integrated undertakings to invest adequately in their networks.

(68) Only the removal of the incentive for vertically integrated undertakings to discriminate against competitors as regards network access and investment can ensure effective unbundling. Ownership unbundling, which implies the appointment of the network owner as the system operator and its independence from any supply and production interests, is clearly an effective and stable way to solve the inherent conflict of interests and to ensure security of supply. For that reason, the European Parliament, in its resolution of 10 July 2007 on prospects for the internal gas and electricity market, referred to ownership unbundling at transmission level as the most effective tool for promoting investments in infrastructure in a non-discriminatory way, fair access to the network for new entrants and transparency in the market. Under ownership unbundling, Member States should therefore be required to ensure that the same person or persons are not entitled to exercise control over a producer or supplier and, at the same time, exercise control or any right over a transmission system operator or transmission system. Conversely, control over a transmission system operator or transmission system should preclude the possibility of exercising control or any right over a producer or supplier. Within those limits, a producer or supplier should be able to have a minority shareholding in a transmission system operator or transmission system.”

546. In Appellant V’s view, the violation of ownership unbundling also infringes Article 3(b) (the CACM objective of “ensuring optimal use of the transmission infrastructure”) and Article 74(6)(a) CACM, requiring the RDCTCS to “(a) provide incentives to manage congestion, including remedial actions and incentives to invest effectively” because it does not ensure an optimal use of the transmission infrastructure.

547. In Appellant V’s view, the violation of ownership unbundling also infringes Article 3(e) (the CACM objective of “ensuring fair and non-discriminatory treatment of TSOs, NEMOs, the Agency, regulatory authorities and market participants” and Article 74(6)(i) CACM, requiring the RDCTCS to “(i) comply with the principles of transparency and non-discrimination.” because it does not ensure a fair and non-discriminatory treatment between market participants.

548. In its view, the violation of ownership unbundling also infringes Article 3(g) (the CACM objective of “contributing to the efficient long-term operation and development of the electricity transmission system and electricity sector in the Union”) and Article 74(6)(e) CACM, requiring the RDCTCS to “(e) facilitate the efficient long-term development and operation of the pan-European interconnected system and the efficient operation of the pan-European electricity market” because it does not ensure an efficient long-term operation and development of the electricity transmission system.

549. Ownership unbundling aims at prohibiting TSOs to favour vertically integrated companies of their economic group, e.g. through discriminatory terms of access to their network infrastructure or through investments tailored to favour those companies.

550. The use of a GSK to translate a net position change of a given BZ into estimated specific injection increases or decreases in the CGM, in a flow decomposition method for RA cost sharing, is unrelated to ownership unbundling. Furthermore, if it were to be a threat to ownership unbundling, *quod certissime non*, the GSK would not be used in the CCM.

551. Consequently, the use of a GSK in the PFC method of the Contested Decision’s RDCTCS neither violates Articles 3(b) and 74(6)(a) CACM, nor Articles 3(e) and 74(6)(i) CACM, nor Articles 3(g) and 74(6)(e) CACM. As set out above in Sub-Pleas 3.13 to 3.16, the use of a GSK ensures a flow decomposition that allows for a fair and non-discriminatory cost attribution, on the basis of the PPP in case of LFs above the threshold. This, in turn, ensures that Core TSOs are given the correct incentives to relieve congestions. Finally, both the GSK and the PFC method ensure consistency between the RDCTCS and the CCM, which is key to an effective CACM in the EU’s zonal market configuration.

3.18 Restrictions on HVDC elements infringe the PPP.

552. Appellant V claims that the PFC method allows decomposing the flows of (i) internal HVDC NEs (HVDC NEs within a BZ) only in IFs and LFs on NEs impacted by them and (ii) CZ HVDC NEs only in AFs on NEs impacted by them, whereas the FLD method allows decomposing the flows of both internal and CZ HVDC NEs into any type of flows (internal and external exchanges) in NEs impacted by them. It refers to paragraphs 93 and 98 of the Contested Decision:

“(93) First, ACER merged all the market flows, i.e. import/export flows and transit flows from all bidding zones into one single flow component defined as allocated flow. This allocated flow represents the cumulative flow resulting from all cross-zonal exchanges (PUBLIC Decision No 30/2020 Page 24 of 41) within and outside the Core CCR and it is therefore the result of cross-zonal capacity allocation. While Core TSOs may further split this component into different import/export flows and transit flows, for the purpose of cost sharing such splitting is not necessary, because all TSOs have agreed that in case the allocated flow is identified as contributing to the congestion, the owner of the congested cross-border relevant network element shall pay for the corresponding costs. For this reason, the cost sharing methodology does not need to identify the specific origins of allocated flow.

(98) The full line decomposition (FLD) method performs the pairing of source and sink injections based on electrical distance, without prior decomposing each source and sink injections that would be predefined to cause internal and cross-zonal component of flows. This method calculates the flow types per network element by multiplying the corresponding nodal injections with nodal PTDFs. The flow types for individual network elements are calculated by filtering and summing the flow contributions according to the flow type definitions for the loop flows, internal flows and allocated flows.”

553. Appellant V stresses that HVDC NEs are developed to contribute to efficient long-term operation and development of the EU electricity transmission system and sector. Its expansion supports the goals of the EU Green Deal in supplying clean, affordable and secure energy. It alleges that the internal German HVDC are defined and recognised as Project of Common Interest (“PCI”) according to Regulation (EU) 347/2013, contributing to the implementation of the strategic energy infrastructure priority corridors and areas in the EU and are essential to achieve the 2030 European interconnection targets by future increasing the market exchanges in the EU.

554. Appellant V alleges that the restrictions to HVDC NEs infringe the PPP, provided by Article 16(13) ER and specified in Article 74(6)(c) CACM. In its view, the PPP excludes flows which do not result from structural congestion from the RDCTCS. The PPP should, in its view, also apply to internal HVDC NEs, which should not be assumed to change IFs and LFS in surrounding Aternate Current (“AC”) networks. Appellant V refers to paragraph 99 of the Contested Decision. Appellant V claims that there is a double burden on the TSOs. Firstly, initial investment into internal HVDC NEs recognised as PCIs and secondly, additional expenses in the RDCTCS.

555. Article 6(8) of Contested Decision’s RDCTCS reads as follows:

“8. The treatment of HVDC lines in flow decomposition shall follow the following principles:

a) Modelling of HVDC network elements in flow decomposition shall be compatible with the virtual hub approach defined within the Core day-ahead and intraday capacity calculation methodologies.

b) Exchanges over HVDC network element located on the bidding zone borders may be decomposed only into allocated flows on such element and other network elements impacted by it. The flow decomposition shall identify the positive injections feeding into the sending node of each such HVDC network element and negative injections supplied by the receiving node of each such HVDC network element and then model and treat such injections as other nodal injections for allocated flows in accordance with the principles described in paragraph 6 above.

c) Exchanges over HVDC network element located within a bidding zone may be decomposed only into internal flow on such network element as well as internal and loop flows on network elements impacted by it. The flow decomposition shall identify the positive injections feeding into the sending node of each such HVDC network element and negative injections supplied by the receiving node of each such HVDC network element and then model and treat these injections as other nodal injections for loop flows and internal flows in accordance with the principles described in paragraph 7 above.”

556. Per definition, there is no allocation (CA) within a BZ. Therefore, internal HVDC NEs do not operate on the basis of CA and their use is *per se* restricted to minimising internal

congestions. Consequently, flows on internal HVDC NEs are unrelated to CA. In other terms, flows on internal HVDC NEs are not allocated by CA, i.e. they are not AFs. The Contested Decision's RDCTCS does not introduce a restriction on the flow decomposition of internal HVDC NEs. Flow decomposition in relation to internal HVDC NEs is *per se* conditioned by their nature. The Contested Decision's RDCTCS correctly states that exchanges over internal HVDC NEs may be decomposed only into IFs on such NE as well as IFs and LFs on NEs impacted by them.

557. This also explains why the Contested Decision's RDCTCS decomposes the flows of CZ HVDC NEs only in AFs on such NE and on NEs impacted by them.

558. CZ HVDC NEs operate on the basis CA. CZ HVDC NEs can only carry exchanges between 2 BZs. Their use is *per se* restricted to AFs. CZ HVDC NEs do not carry IFs because IFs are per definition flows within a BZ, where no allocation takes place. CZ HVDC NEs do not carry LFs because LFs are caused by internal transactions, i.e. exchanges within a BZ, where no allocation takes place. The flow transmitted by CZ HVDC lines on a NE correspond with the volume of allocated CZC on such lines.

559. This is correctly reflected in paragraph 99 of the Contested Decision: *"In power flow colouring method the cross-zonal HVDC network element is assumed to transport only cross-zonal exchanges and thereby change allocated flows in surrounding alternating current ('AC') networks. On the other hand, the internal HVDC network element is assumed to transport only internal exchanges and thereby change internal and loop flows in surrounding AC networks."*

560. Consequently, Appellant V's appeal erroneously claims that the flow decomposition method of the Contested Decision imposes restrictions on HVDC NEs. Any restriction relating to the decomposition of flows on HVDC NEs stems from their intrinsic nature. Any flow decomposition method that does not respect the intrinsic different nature of CZ HVDC NEs and internal HVDC NEs cannot be in compliance with Article 74 CACM as upfront flaws would be created in flow decomposition, which would distort the ensuing cost distribution.

561. Regarding the PPP, Article 16(13) ER requires to identify to what extent *"flows resulting from transactions internal to bidding zones"* cause congestion, i.e. to identify internal flows (IFs and LFs) in a BZ. The treatment of HVDC NEs in the Contested Decision's RDCTCS correctly decomposes AFs in relation to CZC HVDC NEs and IFs/LFs in relation to internal HVDC NEs.

562. Appellant V's claim that the treatment of HVDC lines under the PFC method infringes the PPP because it excludes flows which do not result from structural congestion is incorrect.

563. First, as set out above in the First Consolidated Plea, Sub-Pleas 1.1.3 and 1.1.4, Article 16(13) ER relies upon the significant impact test of the definition of structural congestion according to Article 2(4) ER to determine a *de minimis* threshold. The Contested Decision's RDCTCS scope duly requires that the physical flows resulting from electricity exchanges or transactions internal to BZs - i.e. IFs and LFs - should be identified as contributors to the congestion. It further requires that, when allocating costs, the ensuing cost sharing methodology allocates them by TSOs of the BZs causing such flow, based on the contribution to the congestion to TSOs of BZs. In case of CZ NEs, these flows are LFs, whereas in case of internal NEs, these flows are IFs and LFs (IFs caused by electricity exchanges within the BZ where the NE is located and LFs caused by electricity exchanges within other BZs). The Board of Appeal refers to the Sixth Consolidated Plea, which sets out why LFs above the threshold are the primary contributors to the congestion.

564. Second, by contrast to Appellant V's claim, flow decomposition on the internal HVDC NEs does not impede a correct application of the PPP. The fact that internal HVDC NEs are assumed to change IFs and LFs in surrounding AC networks stems from the intrinsic nature of internal HVDC NEs, which do not operate on the basis of CA and whose use is *per se* restricted to minimising internal congestions. Consequently, flows on internal HVDC NEs are unrelated to CA and exchanges over internal HVDC NEs may be decomposed only into IFs on such NE as well as IFs and LFs on NEs impacted by them.

565. Consequently, both the PFC method and the HVDC NE treatment within the PFC method enable a correct application of the PPP in the attribution of costs to TSOs. Accordingly, the PFC method ensures compliance with Article 16(13) ER. It allows for a correct identification of the polluting flows, namely IFs and LFs. It also allows for a correct decomposition of IFs and LFs, which is a preliminary step to allow for a determination of a *de minimis* LF threshold.
566. Finally, the fact that HVDC NEs require initial investments and are recognised as PCIs is not capable of altering the fact they should be subject to correct flow decomposition under the Contested Decision's RDCTCS in order to ensure compliance with the applicable regulatory framework.
567. Regarding Article 74(6)(c) CACM, which requires the RDCTCS to “(c) ensure a fair distribution of costs and benefits between the TSOs involved”, the Board of Appeal refers to Sub-Pleas 3.3 and 3.4, which set out that the PFC method does not create arbitrary outcomes, resulting in an unfair distribution of costs. Similarly, the treatment of HVDC NEs in the PFC method correctly identifies IFs and LFs, which allows for a fair distribution of costs among TSOs. The FLD method, by contrast, overestimates AFs and underestimates LFs, which, as set out above in Sub-pleas 3.3 and 3.4, distorts cost distribution among TSOs and renders such distribution unfair. Similarly, the possibility to decompose AFs in relation to internal HVDC NEs or IFs/LFs in relation to CZC HVDC NEs under the FLD method, distorts the outcome of the flow decomposition method, which, in turn, has a distortive impact on the ensuing RA cost distribution. The Board of Appeal has analysed all evidence brought by the Appellant and ACER in the Appeal of Appellant V¹¹⁸ and ACER's Defence¹¹⁹, as well as Appellant V's Reply¹²⁰ and ACER's Rejoinder¹²¹. The Board of Appeal assesses, upon careful analysis, that

¹¹⁸ In its Appeal, Appellant V provides a 1st illustration that under the PFC method, (i) a systematic error would occur that the internal HVDC would be both the source and the sink of a LF and (ii) no LF would be triggered if the internal HVDC were to be replaced by a conventional AC line. Appellant V also holds that such systematic error does not occur under the FLD method. Appellant V also provides a 2nd illustration that, under the PFC method, CZ HVDCs trigger artificial cyclic AFs through various BZs, which would not occur under the FLD method.

¹¹⁹ In its Defence, ACER provides two illustrations representing the shape of physical flows on a classic AC interconnector on a BZB and on a CZ HVDC NE on a BZB (the “*Aachen Liège Electricity Grid Overlay*” or ALEGrO over Germany and Belgium) in order to demonstrate that the flow on the HVDC line is fully controlled whereas the AC interconnector has an uncontrollable flow, consisting of AFs, LFs and PSTFs, as well as carrying the effects of load-frequency control and intermittent changes in generation and load. Furthermore, ACER provides a correction to Appellant V's 1st illustration, which (i) erroneously interprets the Contested Decision and leads to an underestimation of IFs transported by the internal HVDC and (ii) omits to explain that LFs on internal HVDC lines are only induced/caused intentionally through the setting of the NE. Given that an optimal setting of internal HVDC NEs avoids LFs, the systematic error alleged by Appellant V is immaterial. ACER furthermore explains that the 2nd illustration of CZ HVDC line exporting from a BZ that does not have energy surplus to a BZ that has energy surplus is completely unrealistic (it could only happen as a result of a RA, which would not affect flow decomposition) and merely reverses the AF by reversing the normal flow as a result of an incorrect setting of the CZ HVDC NE. ACER alleges that Appellant V's claim that the FLD method would create correct flows is false because it would create significant AFs even if all BZs would be balanced and without import or export.

¹²⁰ In its Reply, Appellant V responds (i) with respect to the 1st illustration, that cyclic LFs occur in other situations than situations of suboptimal setting and (ii) with respect to the 2nd illustration, that there is no constraint that electricity flows from a BZ with a surplus to a BZ without a surplus. To this end, it provides a 3rd illustration (Annex 32 to the Reply) namely scatterplot of the DA exchanges on the CZ HVDC NE between the Netherlands and Denmark and the net position of the Dutch BZ. It also provides the CWE Report of February 2020 comparing flow-based plain method and flow-based intuitive method (Annex 33 to the Reply) to demonstrate that the flow-based plain method acknowledges counter-intuitive flows to occur to a significant extent.

¹²¹ In its Rejoinder, ACER argues that (i) the Reply confirms the counter-intuitive nature of this simple example of the 1st illustration, (3 zones, 1 to 3 generation nodes and 3 load nodes) (ii) Annex 33 to the Reply proves the possibility of counter-intuitive complex settings in the meshed European network, (iii) the only way to provide some apparently favourable claims about the FLD method is to provide the counter-intuitive setting, even for the smallest example possible, and (iv) the 3rd illustration (Annex 32) is insufficient because the net positions of other BZs (like the Belgian, German and Swedish BZs) could also explain the counter-intuitive results, and cannot replicate the simple example with 3 zones, 3 generation nodes and 3 load nodes given the complexity of the meshed European network.

the alleged outcome of the evidence provided by Appellant V can either be explained by a suboptimal setting of the HVDC NEs or by the counter-intuitive situations in which they occur and is, consequently, not capable of altering the above conclusions on the alleged infringement of the PPP and Article 74(6)(c) CACM.

3.19 Restrictions on HVDC elements infringe Article 74(6)(a) CACM.

568. Article 74(6)(a) CACM requires the RDCTCS to “(a) provide incentives to manage congestion, including remedial actions and incentives to invest effectively”.
569. Appellant V claims that the RDCTCS is based on assumptions instead of physical reality and this (i) affects RAs and investments of TSOs who implement HVDC technology and (ii) sets wrong incentives to manage congestion. This is because TSOs implementing internal HVDC technology have to account for additional costs for artificial LFs, even though they are considered PCIs and contribute largely to the EU energy market and interconnection targets and comply with positive CBAs according to Article 11 of Regulation (EU) 347/2013. In addition, Appellant V alleges that the RDCTCS provides the wrong incentives to TSOs (i) to implement less efficient technology, like AC technology instead of HV technology, or (ii) not to invest in the capacity of CB lines despite the likely occurrence of congestions.
570. As set out above in Sub-Plea 3.18, the treatment of HVDC NEs under the PFC method correctly identifies the physical flow components in order to allow for due cost distribution to Core TSOs. It is not based on fictitious flows and ensures consistency of RA coordination with other CACM measures within the EU zonal market design. Appellant V erroneously states that the treatment of HVDC NEs under the Contested Decision’s RDCTCS causes “artificial” LFs. As demonstrated by ACER in its Defence¹²², the PFC method correctly identifies more LFs than the FLD method with respect to AC NEs and identifies less LFs than the FLD method with respect to HVDC NEs.
571. Flows relating to HVDC NEs are correctly decomposed in accordance with Article 16(13) ER. This enables cost distribution down the line to comply with the cost sharing principles of the RDCTCS. By enabling a correct identification of LFs, the treatment of HVDC NEs in the PFC method allows for a penalisation of primary contributors to the congestion, i.e. LFs above the threshold, in accordance with the PPP. A correct application of the PPP, in turn, provides the correct incentives to the LF causing TSOs so that they take the necessary measures to reduce LFs below the threshold. Core TSOs are provided with correct incentives in relation to the use of AC technology and investments in HV technology.
572. By contrast, a distorted decomposition of LFs in relation to HVDC NEs under the FLD method distorts the cost distribution outcome and consequently fails to provide the correct incentives to Core TSOs.
573. Again, the fact that HVDC NEs require initial investments and are recognised as PCIs is not capable of altering the fact they should be subject to a correct flow decomposition under the Contested Decision’s RDCTCS in order to ensure compliance with the applicable regulatory framework.
574. Appellant V also claims that the treatment of HVDC NEs under the PFC method infringes Article 3(b) CACM (the CACM objective of “ensuring optimal use of the transmission infrastructure”), Article 3(c) CACM (the CACM objective of “ensuring operational security”, Article 3(g) CACM (the CACM objective of “contributing to the efficient long-term operation and development of the electricity transmission system and electricity sector in the Union”), Article 74(6)(g) CACM, requiring the RDCTCS to “(g) allow reasonable financial planning” and Article 16(1) ER, which states “Network congestion problems shall be addressed with non-discriminatory market-based solutions which give efficient economic signals to the market participants and transmission system operators involved. Network congestion problems shall be solved by means of non-transaction-based methods, namely methods that do not involve a selection between the contracts of individual market participants. When taking

¹²² Defence, paras 399-401.

operational measures to ensure that its transmission system remains in the normal state, the transmission system operator shall take into account the effect of those measures on neighbouring control areas and coordinate such measures with other affected transmission system operators as provided for in Regulation (EU) 2015/1222.”

575. As set out above, the PFC method correctly captures the characteristics of HVDC technology in the flow decomposition, correctly identifies LFs in relation to such NEs and accordingly allows for a correct penalisation of LFs above the threshold in the ensuing cost distribution to Core TSOs. The treatment of HVDC NEs in the PFC method therefore (i) provides correct incentives to Core TSOs with respect to the choice of CM measures, including investments in adequate technology, (ii) gives efficient economic signals to TSOs and market participants and (iii) allows for a reasonable financial planning. Moreover, Article 6(2) of the Contested Decision’s RDCTCS allows Core TSOs to calculate different sub-components of the flow components for the purpose of transparency and auditability. The correct level of investments and economic signals, in turn, ensure an optimal use of transmission infrastructure whilst guaranteeing OS and contribute, in the long run, to an efficient long-term operation and development of the electricity transmission system and electricity sector in the EU.

3.20 Restrictions on HVDC elements infringe Article 74(6)(e) and 3(b) and (g) CACM.

576. Article 74(6)(e) CACM requires the RDCTCS to “(e) facilitate the efficient long-term development and operation of the pan-European interconnected system and the efficient operation of the pan-European electricity market”.

577. Appellant V claims that the restrictions to HVDC NEs do not reflect the efficient long-term development and operation of the pan-European interconnected system and electricity market. This is because, in its view, the Contested Decision’s RDCTCS does take into account that internal HVDC NEs (i) are important contributors to increasing network capacity and to integrating electricity through renewable energy sources (“RES”) into the network and (ii) has a positive impact on market integration in at least two EU countries, as provided by Article 4(c)(i) of Regulation (EU) 347/2013. It therefore views that these lines should not be disadvantaged over other lines, which contribute less to the EU electricity system.

578. It also infringes, in its view, Article 3(b) CACM (the CACM objective of “ensuring optimal use of the transmission infrastructure”) and Article 3(g) CACM (the CACM objective of “contributing to the efficient long-term operation and development of the electricity transmission system and electricity sector in the Union”).

579. The PFC method correctly captures the characteristics of HVDC technology when decomposing flows. As set out above in Sub-Plea 3.19, the treatment of HVDC NEs under the PFC method provides a correct level of investments and economic signals and ensures an optimal use of transmission infrastructure whilst guaranteeing OS, which, in the long run, contributes to an efficient long-term operation and development of the electricity transmission system and the zonal electricity market in the EU. As will be set out below in Sub-Plea 3.21, HVDC technology is not unjustifiably disadvantaged in comparison with other technology in relation to flow decomposition.

3.21 Restrictions on HVDC elements infringe Articles 2(3) and 3(h) ER.

580. Appellant V refers to the definitions of CB flow in Articles 2(3) and 3(h) ER. Article 2(3) ER defines CB flow as a “physical flow of electricity on a transmission network of a Member State that results from the impact of the activity of producers, customers, or both, outside that Member State on its transmission network”. Article 3(h) ER contains, as a principle for the operation of electricity markets, that “barriers to cross-border electricity flows between bidding zones or Member States and cross-border transactions on electricity markets and related services markets shall be progressively removed”.

581. Appellant V claims that the ER does not contain limitations in its definitions, whereas the Contested Decision’s RDCTCS introduces limitations: the restrictive assumptions regarding HVDC lines do not comply with the ER’s definitions because they predefine certain types of flows and are not based on the actual physical flows.

582. As set out above in Sub-Pleas 3.18 to 3.20, the treatment of HVDC NEs under the PFC method (i) does not contain any restrictions that are not tied to their intrinsic different nature, (ii) correctly identifies the physical flow components in order to allow for due cost distribution to Core TSOs, and (iii) is not based on fictitious flows but ensures consistency of RA coordination with other CACM measures within the EU zonal market design.
583. Article 2(3) ER defines CB flows as flows with an impact outside a BZ: it encompasses, therefore, both AFs and LFs. However, the principle for the operation of electricity markets of Article 3(h) ER uses the term CB flow in a narrower way because it only refers to CB flows in relation to CB transactions and, therefore, only refers to AFs because LFs are a result of internal transactions.
584. Appellant V's plea is moot because Article 6(8) of the Contested Decision's RDCTCS does not use the term CB flow. It correctly states that (i) exchanges over internal HVDC NEs may only be decomposed into IFs on such NE as well as IFs and LFs on NEs impacted by them and (ii) exchanges over CZ HVDC NEs may be decomposed only in AFs on such NE and on NEs impacted by them.
585. **It follows that the Third Consolidated Plea must be dismissed as unfounded.**
586. Appellants' claims on an infringement of the principle of discrimination are dealt with separately in the Twelfth Consolidated Plea.
587. Appellants' claims on an infringement of duty to reason are dealt with separately in the Seventeenth Consolidated Plea.

Fourth Consolidated Plea – Overestimation of loop flows and internal flows from importing zones.

588. Appellant I¹²³ claims that Article 6(6) and (7) of the Contested Decision's RDCTCS overestimates LFs and IFs for importing zones because imports are incorrectly classified as internal transactions of importing BZs. This leads to an incorrect cost allocation for these importing zones, forced to contribute to the costs of LFs that they did not create, in violation of Articles 74(6)(c) and (i) CACM and 16(13) ER. It creates the paradox that, even if a BZ imports 100% of its electricity demand, it also produces IFs and LFs in spite of its internal generation being 0 MW. Appellant I adduces that the overestimation of LFs and IFs for importing zones is acknowledged by ACER in paragraph 102 of the Contested Decision, where ACER proposes a solution based on a GSK harmonisation between CC and flow decomposition. Appellant I considers this solution to be insufficient and incorrect because (i) the Contested Decision's RDCTCS does not contain a provision indicating precise changes to be made to the CC methodologies, (ii) the issue is not only related to a modification of the shift key but primarily to a modification of the direction of the shift (a shift in load instead of a shift in generation) and (iii) amendments to the CC methodologies alone are not sufficient to solve the issue, since they need to be accompanied by adequate changes of at least Article 6(6) and (7) of the Contested Decision's RDCTCS.
589. ACER's Defence¹²⁴ holds that the simulation of Appellant I rests on the assumption of a single scenario in the absence of import or export whereas in reality there is a multitude of possible scenarios due to the fact that the GLSK is a combination of load and generation nodes and this combination will adjust generation and load in exporting and importing zones. To illustrate this, the Defence sets out 4 possible scenarios and argues that the scenario put forward by Appellant I is the least expected real-time scenario due to load inelasticity: in the absence of imports, it is very likely for generation nodes to generate more supply to the load nodes, without the latter reducing consumption/withdrawal. ACER adds that, according to the Contested Decision's RDCTCS, TSOs remain free to define the GLSK and to modify the GLSK if it overestimates LFs and IFs (as long as they do not negatively impact the accuracy

¹²³ Appeal I, Plea 1, paras 23-29.

¹²⁴ Defence, paras 377-388.

of CC). Hence, nothing prevents TSOs from using only load nodes in their GLSK when BZs are importing electricity. This would avoid the alleged paradox, which, in ACER's view, is purely theoretical because, in practice, due to OS issues (e.g. voltage stability) a certain level of load nodes always needs to be supplied by generation nodes close to loads.

590. Article 6(6) and (7) of the Contested Decision's RDCTCS, entitled "*Flow decomposition on XNECs*" reads as follows:

"6. The nodal injections for allocated flows are calculated by multiplying the net positions contained within the CGM, with the factors contained within the GSK that is used in the application of day-ahead capacity calculation methodology and/or intraday capacity calculation methodology by the concerned Core and non-Core bidding zones. In the absence of such GSK for a certain bidding zone, the default GSK shall be used for such zone, where the factors are determined in proportion to generation in the generation nodes of that bidding zone. The allocated flow pursuant to paragraph 1(b) is then calculated by multiplying all the nodal injections for allocated flow from each bidding zone with node-to-hub PTDF factors and summarising the contributions from all such nodal injections for each XNEC.

7. The nodal injections used for the calculation of loop flows and internal flows are the nodal injections calculated pursuant to paragraph 3 reduced by nodal injections for allocated flows pursuant to paragraph 6. The loop flows and internal flows are then calculated by multiplying all the nodal injections for loop flows and internal flows with node-to-hub PTDF factors and summarising the contributions from all such nodal injections as follows:

- (a) for loop flows outside the Core CCR, all contributions from non-Core bidding zones are summarised for each XNEC;*
- (b) for loop flows from each bidding zone in the Core CCR, all contributions from a particular Core bidding zone are summarised for each XNEC; and Page 14 of 19*
- (c) for internal flow, which is calculated only when the concerned XNE is an internal network element, all contributions from a Core bidding zone where the concerned XNE is located, are summarised for such XNEC."*

4.1 The decomposition of flows contradicts the definitions of Article 2 of the Contested Decision's RDCTCS.

591. Appellant I claims that these definitions imply that all flows have to be physical flows, i.e. that each component has to comply with the laws of physics, which implies that the source can only be a generation node and the sink can only be a load node. The decomposition of flows of Contested Decision's RDCTCS, however, only assumes adjustment on the generation side (GSK only) regardless of whether a given zone is exporting or importing. This leads to a calculation of LFs and IFs for importing zones and of AFs which is incorrect in the light of the definitions.

592. The Contested Decision's RDCTCS defines an AF as "*a physical flow on a network element where the source and sink are located in different bidding zones*" (Article 2(a) of the Contested Decision's RDCTCS); an IF as "*a physical flow on a network element where the source and sink and the complete network element are located in the same bidding zone*" (Article 2(o) of the Contested Decision's RDCTCS) and a LF as "*a physical flow on a network element where the source and sink are located in the same bidding zone and the network element or even part of the network element is located in a different bidding zone*" (Article 2(p) of the Contested Decision's RDCTCS).

593. As set out above in Sub-Plea 3.2 of the Third Consolidated Plea, the Contested Decision's RDCTCS decomposes flows AFs (market flows, i.e. import/export flows and transit flows), LFs, IFs or PST flows. The PFC method identifies, for each node in the CGM, the components causing flows in positive and negative nodal injections (sources and sinks) and converts them into different types of flows (AFs, LFs, IFs) on the basis of nodal PTDFs. It uses a GSK to determine CZC nodal injections and internal nodal injections, which are respectively converted into AFs and IFs/LFs on the basis of PTDFs. AFs are not further decomposed because costs from AFs are distributed according to the OPP. IFs and LFs are decomposed. Decomposition is performed per BZ, to ensure consistence with the zonal market configuration.

594. Appellant I's claim that the PFC method allegedly decomposes flows that are not physical flows is linked to the fact that the PFC method is based on an upfront identification of CZC

injections and internal injections, which are respectively converted into AFs and IFs/LFs. The GSK calculates the flow that would occur when BZs neither import nor export and calculates the AF as the difference between the total physical flow and the physical flow without any imports and exports. This method of identification of AFs does not alter the nature of an AF as a physical flow.

595. As set out above in Sub-Plea 3.3 of the Third Consolidated Plea, the use of a GSK to split internal and CZC injections and deduct AFs does not render the method, or any part of it, invalid. The use of a GSK is a standard feature of other CACM methods in the EU, both in Core CCR and other CCRs.
596. In its Reply¹²⁵, Appellant I confirms that the calculation of AF in CC is used by assuming that both sources and sinks are generators. Appellant I does not set out why the same assumption would not be acceptable for flow decomposition in cost sharing. As set out by ACER in its Rejoinder¹²⁶, both the flow decomposition in cost sharing and the CC need to calculate AFs based on the variation of the net positions of the BZs. Indeed, if the CC method calculates AFs to be 70% of maximum flows (as required by Article 16(8) ER and a flow decomposition method in cost sharing would calculate AFs, based on other assumptions, to be 110% of maximum flows, the Contested Decision's RDCTCS would incorrectly attribute congestion to AF whereas in act the real AF should be 70%. That is the reason why the assumptions in both methods need to be exactly the same, i.e. to avoid results which are completely at odds with CC.
597. Appellant I provides an example in its Reply¹²⁷: *“A simply example explains why applying measures proposed by the Contested Decision could lead to unexplainable outcomes: let us consider a zone with expensive production facilities which imports the entire amount of power demanded by its consumers (let us assume the total demand equal 10 GW). For the purpose of performing decomposition of power flow, the method introduced by ACER assumes as if this zone have satisfied its demand locally, and consequently, as if it would have generated 10 GW which would have resulted in internal flows as a consequence of such an internal exchange.”*
598. The Board of Appeal finds, in line with ACER's Rejoinder¹²⁸, that ACER does not prescribe the use of generators as the only way for modelling sinks. In Appellant I's example, if TSOs assume that demand is flexible, it would be completely normal and expected that demand would reduce load. This would be modeled by LSK in CC and cost sharing. Consequently, the result of Appellant I's example would not be valid. As set out in ACER's Rejoinder: *“However, if TSOs assume that demand is inflexible (as Appellant I assumed in paragraph 20 of its Reply), TSOs would need to assume that instead of demand reducing load, the generators would increase production”*.¹²⁹
599. As a consequence, the PFC method does not contradict the definitions of Article 2 of the Contested Decision's RDCTCS. The PFC method correctly decomposes physical flows in order to allow the cost sharing solution to attribute costs to TSOs using a methodology that creates reliable results in a zonal market design.

4.2 The decomposition of flows discriminates between importing zones and exporting zones and infringes Article 74(6)(c) and (i) CACM.

600. Appellant I claims that the Contested Decision's RDCTCS overestimates LFs and IFs for importing zones because imports are incorrectly classified as internal transactions of importing BZs. This implies that LFs are penalised in the first place, and importing zones are being forced to pay for a part of LFs that they do not cause. This amounts to an incorrect cost allocation for these importing zones, forced to contribute to the costs of LFs that they did not create, in violation of Articles 74(6)(c) and (i) CACM. It creates the paradox that, even if a

¹²⁵ Appellant I's Reply, para 20.

¹²⁶ Rejoinder, para 20.

¹²⁷ Appellant I's Reply, para 25.

¹²⁸ Rejoinder, para 36.

¹²⁹ Rejoinder, para 36.

BZ imports 100% of its electricity demand, it also produces IFs and LFs in spite of its internal generation being 0 MW.

601. At the Oral Hearing, Appellant I held that ACER’s approach to use a GSK for obtaining a zonal equilibrium between generation and load is an incorrect approach because the load is not divided at all. It claimed that this causes an overestimation of LFs and IFs for importing zones.

602. Article 74(6)(i) CACM requires the RDCTCS to “(i) comply with the principles of transparency and non-discrimination.”.

603. Article 74(6)(c) CACM requires the RDCTCS to “(c) ensure a fair distribution of costs and benefits between the TSOs involved”.

604. Appellant I illustrates this with a simulation of flow decomposition under two different scenarios: (i) an alleged correct flow decomposition using GSK/Load Shift Key (“LSK”), in line with the definitions of Article 2 of the Contested Decision’s RDCTCS and with All Core TSO’s Experimentation Report; and (ii) an alleged incorrect flow decomposition, using GSK only, in line with Article 6(6) and (7) of the Contested Decision’s RDCTCS. Appellant I claims that the illustrations show that the definition of AFs as physical flows is violated, as the generation node in the importing BZ becomes the sink, whilst energy exchange only occurs between the generation nodes from the exporting BZ to the importing BZ. This, in its view, contradicts the laws of physics and the expected direction of CZ power exchange. Given that all flows must sum up to the total flow, the LFs and IFs for the importing zones are also overestimated.

605. Appellant I’s illustration is as follows:

Figure 1 of Appeal I.

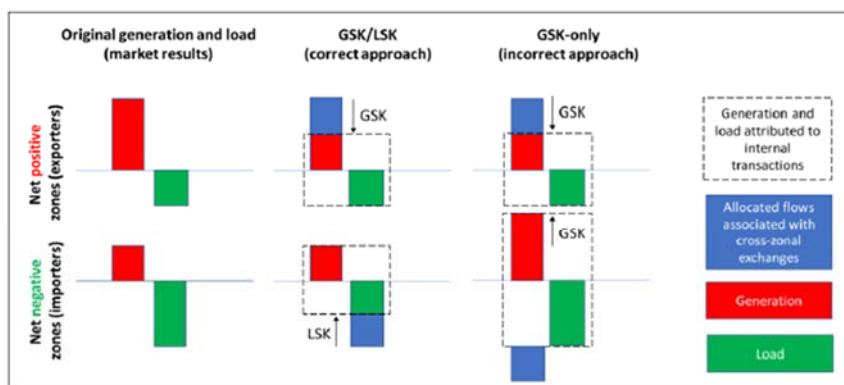

Figure 1. Two approaches to flow decomposition: the correct GSK/LSK approach compliant with flow components definition and the incorrect GSK-only approach as adopted in the Contested Decision.

Source: Appeal of Appellant I, paragraph 23.

606. The GSK produces a large variety of scenarios on the basis of a combination of generation and load nodes and these scenarios produce different outcomes. Figure 1 of Appeal I is based on an underlying assumption that no exchange occurs between exporting BZs and importing BZ, i.e. that the CZC is zero. Within this assumption, the correct GSK/LSK approach makes another assumption that the generators in the exporting zone generate less and that the loads in the importing zone consume less (“Appellant I’s scenario”).

607. As set out by ACER’s Defence¹³⁰, under an assumption that no exchange occurs between exporting BZs and importing BZs, there are at least 4 possible scenarios, summarised as follows as “options” (option 1 to 4).

Option	Generators in exporting zone	Loads in exporting zone	Generators in importing zone	Loads in importing zone	GLSK of exporting zone	GLSK of importing zone
Option 1	Less	Equal	equal	less	G nodes	L nodes

¹³⁰ Defence, paras 379-380.

Option 2	equal	More	more	equal	L nodes	G nodes
Option 3	equal	More	equal	less	L nodes	L nodes
Option 4	Less	Equal	more	equal	G nodes	G nodes

Source:
ACER's

Defence, paragraph 380.

608. The correct GSK/LSK approach in Appellant I's scenario of Figure 1 of Appeal 1 corresponds with "option 1" of the table of ACER's Defence. The GSK for the exporting zone includes only generation nodes and the GSK for the importing zone includes only load nodes.
609. This scenario is the least expected scenario in reality due to inelasticity of load in electricity markets: electricity demand (load) is inelastic as compared to electricity supply (generation).
610. As set out by ACER's Defence¹³¹, Appellant I does not demonstrate why only load nodes would be adjusted in importing BZs in the absence of imports. In the absence of imports, the likelihood is high that generators would generate more generation nodes to supply load nodes, whereas load nodes would not reduce electricity demand.
611. The likelihood of the other scenarios is higher, namely:
- "option 2": the generators in the importing zone generate more and the loads in the exporting zone consume more; the GSK for the exporting zone includes only load nodes and the GSK for the importing zone includes only generation nodes;
 - "option 3": the loads in the exporting zone consume more and the loads in the importing zone consume less; the GSK for the exporting zone includes only load nodes and the GSK for the importing zone includes only load nodes;
 - "option 4": this scenario corresponds with the "GSK-only incorrect approach" of Figure 1 of Appeal 1: the generators in the exporting zone generate less and the generators in the importing zone generate more; the GSK for the exporting zone includes only generation nodes and the GSK for the importing zone includes only generation nodes.
612. Appellant I provides a second illustration. This second illustration is reproduced below as Figure 2 of Appeal 1. It distinguishes between scenario (a), representing correct flow decomposition according to the GSK/LSK approach and scenario (b), representing an incorrect flow decomposition according to a GSK-only approach. It is based on the following assumptions: (i) 2 BZs (A and B) have only one generation node in the North and only one load node in the South, (ii) BZ B imports 100 MW from BZ A, and (iii) the same impedances on all lines.

¹³¹ Defence, para 384.

Figure 2 of Appeal I.

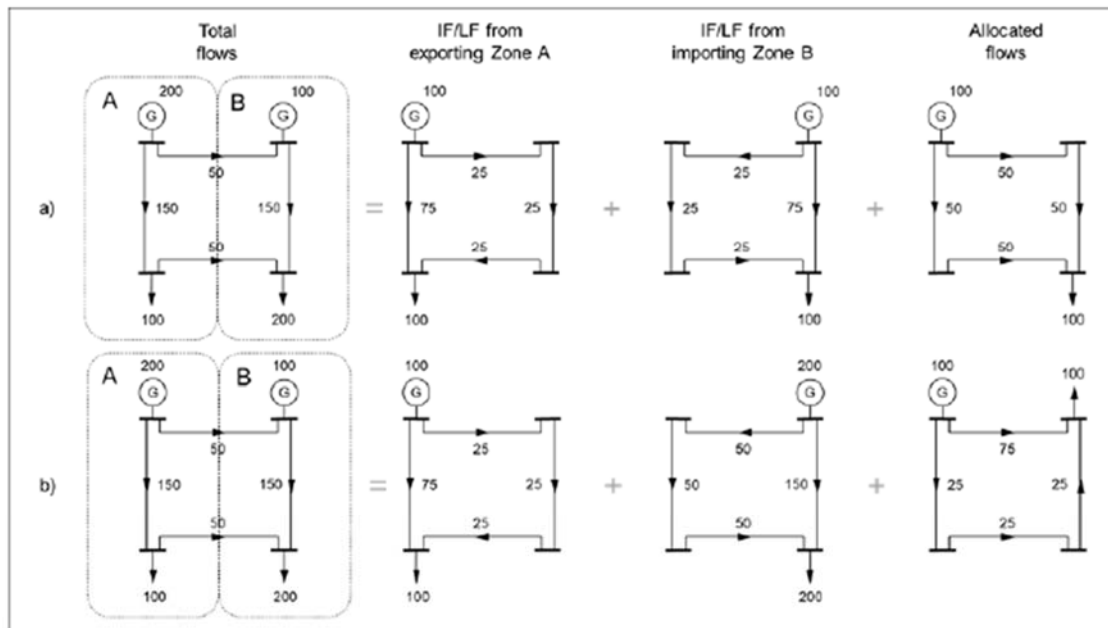

Figure 2. Illustrative numerical example of a) correct flow decomposition according to GSK/LSK approach and b) incorrect flow decomposition according to GSK-only approach. The example assumes import of 100 MW to BZ B from BZ A and the same impedances of all lines.

Source: Appeal of Appellant I, paragraph 23.

613. Scenario (a) of Figure 2 of Appeal 1 is a variant of “option 1” of Figure 1 to the Appeal (modifying the zero CZC into a CZC of 100 MW): the export from BZ A is modelled as an increase of injection (generation) at the generation node and an import into BZ B is modelled as an increase of withdrawal (load) at the load node. Given that the PFC method of the Contested Decision’s RDCTCS determines the nodal injections for total AFs consistently with the calculation of flows by multiplying the net position (-100 MW for BZ B) with the factors contained in the GSK, this results in an increase of the withdrawal (load) at the load node located in the South of BZ B. Given that the PFC method of the Contested Decision’s RDCTCS determines the nodal injections for LFs and IFs by subtracting the nodal injections for AFs from the nodal injections for total physical flow, this results for BZ B in (i) an injection of 100 MW at the generation node (located in the North of BZ B), which is equal to the difference between 100 MW injected at the generation node as reflected by the total physical flows and 0 MW injected at the generation node as reflected by the AFs and (ii) a withdrawal of 100 MW at the load node (located in the South of BZ B), which is equal to the difference between 200 MW withdrawn at the load node as reflected by the total physical flows and 100 MW withdrawn at the load node as reflected by the AFs.
614. Scenario (b) of Figure 2 of the Appeal 1 is a variant of “option 4” of Figure 1 to the Appeal (modifying the zero CZC into a CZC of 100 MW): the export from BZ A is modelled as an increase of injection (generation) at the generation node and the import in BZ B is modelled as a decrease of injection (generation) at the generation node. Given that the PFC method of the Contested Decision’s RDCTCS determines the nodal injections for total AFs consistently with the calculation of flows by multiplying the net position (-100 MW for BZ B) with the factors contained in the GSK, this results in a decrease of the injection (generation) at the generation node located in the North of BZ B. Given that the PFC method of the Contested Decision’s RDCTCS determines the nodal injections for LFs and IFs by subtracting the nodal

injections for AFs from the nodal injections for total physical flow, this results for BZ B in (i) an injection of 200 MW at the generation node (located in the North of BZ B), which is equal to the difference between 100 MW injected at the generation node as reflected by the total physical flows and -100 MW injected at the generation node as reflected by the AFs and (ii) a withdrawal of 200 MW at the load node (located in the South of BZ B), which is equal to the difference between 200 MW withdrawn at the load node as reflected by the total physical flows and 0 MW withdrawn at the load node as reflected by the AFs.

615. ACER's Defence¹³² demonstrates this by adding clarifications to Figure 2 of the Appeal 1 as follows:

Figure 2 of Appeal 1 with illustrations by ACER.

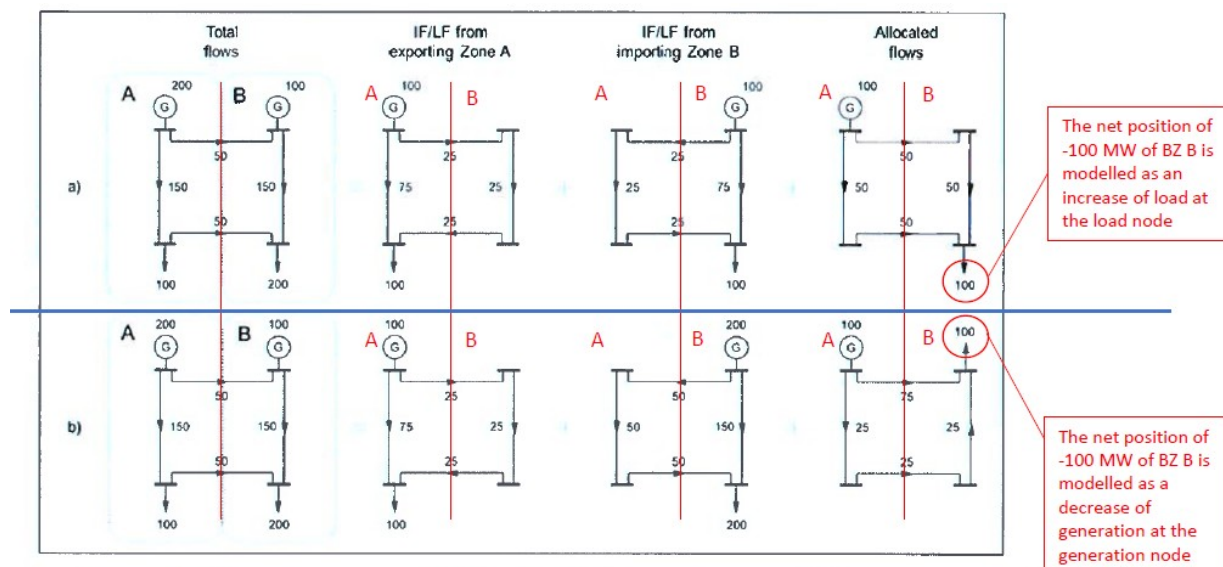

Figure 2. Illustrative numerical example of a) correct flow decomposition according to GSK/LSK approach and b) incorrect flow decomposition according to GSK-only approach. The example assumes import of 100 MW to BZ B from BZ A and the same impedances of all lines.

Source: Defence, paragraph 378.

616. As set out above, the likelihood of (i) the correct GSK/LSK approach in Appellant I's scenario of Figure 1 of Appeal 1 (corresponding with "option 1" of the table of paragraph 389 of ACER's Defence), (ii) the underlying assumption of Figure 1 of Appeal 1 (contrary to the fact that generators in exporting zones usually supply loads in importing zones) and (iii) its variant in scenario (a) of Figure 2 of Appeal 1, is limited given the inelasticity of electricity demand.

617. Furthermore, the likelihood of the alleged paradox - that, even if a BZ imports 100% of its electricity demand, it also produces IFs and LFs in spite of its internal generation being 0 MW - is limited because OS issues (e.g. voltage stability) imply that a certain level of load nodes always needs to be supplied by generation nodes close to loads.

618. In any event, it is possible for Core TSOs to avoid the alleged paradox by using an appropriate GSK in case the BZ is importing electricity. Core TSOs that expect that a BZ will import may use a GSK that only includes load nodes. In so doing, Core TSOs would ensure that for importing zones only the load nodes are considered when calculating the AFs. Core TSOs can thus tailor the GSK to their needs, as long as it is consistent with the GSK that is used in the CCM and does not negatively impact the accuracy of the CC process.

619. As set out above in the Third Consolidated Plea, Sub-Pleas 3.13 to 3.16, neither the Contested Decision nor the DA Core CCM/ID Core CCM contains requirements on the use by Core

¹³² Defence, para 378.

TSOs of the GSK. The only requirement is that the GSK that is used for flow decomposition under the RDCTCS is consistent with the GSK that is used for CCM, in accordance with Article 74(6)(d) and (h) CACM. This is set out in paragraph 102 of the Contested Decision: “ACER agrees with these concerns and suggested that the concerned TSOs try to **harmonise generation shift key methodology** between capacity calculation and flow decomposition such that the same assumptions about imports of electricity are made in both areas. This is needed to ensure that the flow components calculated during capacity calculation are **aligned as much as possible** with the flow components calculated during cost sharing. With this regard, the generation shift key method defined in capacity calculation methodologies should be **flexible enough to accommodate this consistent approach**.” (emphasis added)

620. As set out above in the Third Consolidated Plea, Sub-Pleas 3.3 and 3.4, consistency between the RDCTCS and the CCM processes is key to an efficient CACM within the EU’s zonal market configuration.

621. In light of the above, even indulging the improbable assumptions put forward by Appellant I, Core TSOs are allowed to tailor the GSK of the Contested Decision’s RDCTCS in order to avoid *ex ante* any possible negative impact on importing BZs.

622. In its Reply¹³³, Appellant I provides another example:

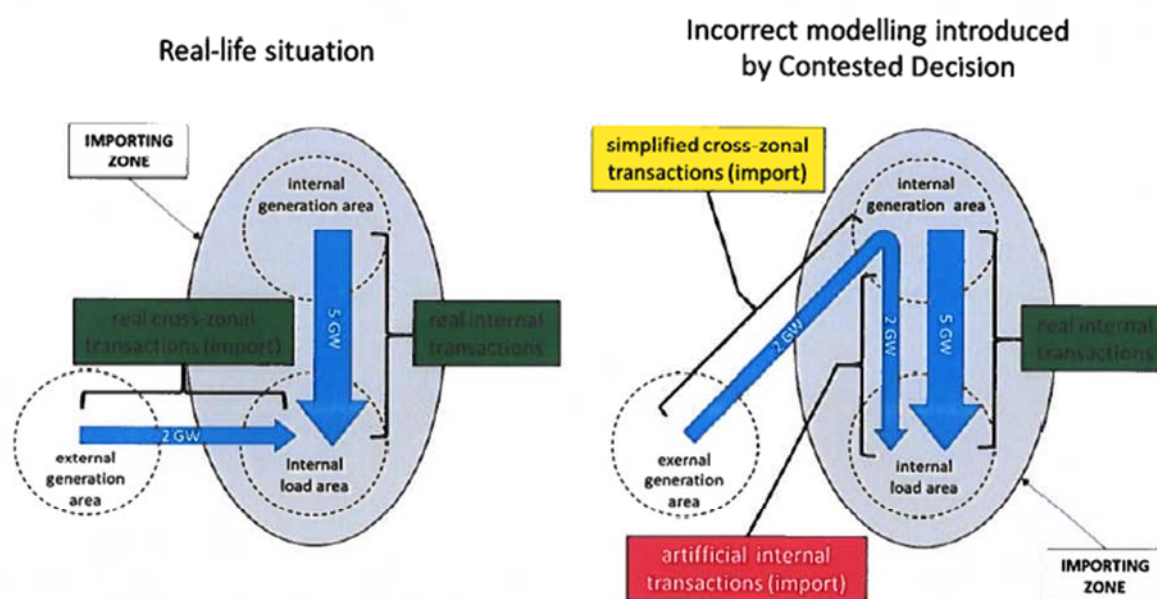

Figure - Comparison of a real-life situation regarding an importing zone (on the left) against incorrect modeling as introduced by the Agency (on the right). According to the Contested Decision imported energy should first supply local generation in order to produce additional and artificial internal exchange within the zone. Supplying generation with imported energy has never been observed in power systems.

623. The Board of Appeal finds, in line with ACER’s Rejoinder, that net internal trade is indeed the lower of the internal generation and load, but that this net value has two components, i.e. gross internal trade and CB trade. In the picture, the gross-internal trade is 7 GW and the CB trade is 2 GW. Therefore, Appellant I only focuses on net trade and net physical flows and ignores that net values have different components, which can be either negative or positive.

624. The flow decomposition method of the Contested Decision’s RDCTCS neither discriminates between importing zones and exporting zones in violation of Article 74(6)(i) CACM nor creates an unfair distribution of costs and benefits between Core TSOs.

4.3 The decomposition of flows infringes Article 16(13) ER.

625. Appellant I claims that the Contested Decision’s RDCTCS leads to a penalisation of flows resulting from CZ transactions which infringes Article 16(13) ER. This is because CZ

¹³³ Appellant I’s Reply, para 30.

transactions create artificial internal transactions in the importing zone, which, in turn, result in additional LFs and IFs of this zone. As the LFs and IFs are subject to penalisation, such an approach increases the share of costs borne by the importing zone.

626. Appellant I alleges that ACER expressly acknowledges the overestimation of LFs and IFs for importing zones in paragraph 102 of the Contested Decision, which reads:

“Some Core TSOs and NRAs expressed concerns that the generation shift key used in capacity calculation is not appropriate for the flow decomposition for importing bidding zones (i.e. bidding zones that import electricity in a specific hour). This is because the generation shift key used in capacity calculation models the import of electricity as reduction of generation in such zone, whereas in flow decomposition the import of electricity is proposed to be modelled as increase of consumption in such bidding zone.

Therefore, flow decomposition with the generation shift key from capacity calculation would artificially increase the internal exchanges in such bidding zones (which are calculated in the absence of electricity imports) and thereby increase loop flows and internal flows. ACER agrees with these concerns and suggested that the concerned TSOs try to harmonise generation shift key methodology between capacity calculation and flow decomposition such that the same assumptions about imports of electricity are made in both areas. This is needed to ensure that the flow components calculated during capacity calculation are aligned as much as possible with the flow components calculated during cost sharing. With this regard, the generation shift key method defined in capacity calculation methodologies should be flexible enough to accommodate this consistent approach.”

627. Appellant I views that the solution adopted by ACER in paragraph 102 of the Contested Decision is insufficient and incorrect. This is because (i) there is no provision indicating precise changes to be made in the CCMs, neither in the Contested Decision nor in the Contested Decision’s RDCTCS; and (ii) the Contested Decision’s RDCTCS based on GSK harmonisation does not solve the problem, since the matter is not only the modification of the shift key, but primarily the direction of the shift in case of importing zones, i.e. a shift in load instead of a shift in generation. Moreover, amendments in CCMs alone are not sufficient to solve the issue, given that they need to be accompanied by adequate changes of Articles 6(6) and (7) of the Contested Decision’s RDCTCS.

628. At the Oral Hearing, Appellant I held that ACER’s approach to use a GSK for obtaining zonal equilibrium between generation and load is an entirely wrong approach because the load is not divided at all and this triggers an overestimation.

629. Article 16(13) ER reads as follows: *“When allocating costs of remedial actions between transmission system operators, regulatory authorities shall analyse to what extent flows resulting from transactions internal to bidding zones contribute to the congestion between two bidding zones observed, and allocate the costs based on the contribution to the congestion to the transmission system operators of the bidding zones creating such flows except for costs induced by flows resulting from transactions internal to bidding zones that are below the level that could be expected without structural congestion in a bidding zone. That level shall be jointly analysed and defined by all transmission system operators in a capacity calculation region for each individual bidding zone border, and shall be subject to the approval of all regulatory authorities in the capacity calculation region.”*

630. The Board of Appeal refers to Sub-Pleas 4.1 and 4.2 above on the improbability of the scenarios adduced by Appellant I and the possibility to tailor the GSK used for flow decomposition in the RDCTCS in order to avoid *ex ante* any negative impact on the correct identification of IFs and LFs, in accordance with Article 16(13) ER and the ensuing cost distribution among Core TSOs.

631. It follows that the Fourth Consolidated Plea must be dismissed as unfounded.

Fifth Consolidated Plea – Netting of flow components.

632. Appellant IV¹³⁴ claims that Article 7 of the Contested Decision’s RDCTCS (distribution of costs on XNECs to TSOs) does not net flows and only considers burdening flows and not relieving flows. In its view, this does not adequately take account of the realities of physics and the applicable legal framework. Appellant IV adduces that a failure to net flow components (i) infringes Article 74(6)(b) CACM, which requires the RDCTCS to be

¹³⁴ Appeal IV, Plea 2, paras 66-92.

consistent with the responsibility and liability of the TSOs because Core TSOs have (a) an obligation to net in accordance with Article 16(11) ER and (b) an obligation to net when identifying the extent to which flows contribute to congestion in accordance with Article 16(13) ER; (ii) over-penalises LFs by requiring Core TSOs to fictitiously assume that there are no relieving flows reducing gross LFs into net LFs; (iii) infringes Article 74(6)(f) CACM, which requires the RDCTCS to facilitate adherence to the netting principle as a general principle of CM in accordance with Article 16(11) ER; (iv) infringes Article 74(6)(c) CACM, which requires the RDCTCS to ensure a fair distribution of costs and benefits between TSOs involved; and (v) infringes Article 74(6)(d) CACM, which requires the RDCTCS to be consistent with the ITC as set out in Article 13 of the Old ER (Articles 70 and 49 ER).

633. Appellant V¹³⁵ claims that Article 6(1) of the Contested Decision's RDCTCS (flow decomposition on XNECs) infringes Article 16(13) ER and Articles 3(e) and (f) CACM as well as 74(5)(e) and 74(6)(c),(e),(i),(a) CACM. It opposes an aggregation of individual flows per XNEC and flow type alleging that cost sharing should take place at BZ level and not NE level. It also claims that a failure to net burdening and relieving flows leads to a distortive assumption being used as basis for cost allocation under Article 16(13) ER. In its view, the RDCTCS' aggregation of burdening and relieving flows per XNEC excluding LFs caused by Core BZs unduly discriminates LFs compared to other types of flows and does not ensure a fair and transparent cost distribution, hampering, in turn, due monitoring by NRAs, efficient investment signals and long-term development of the EU grid and electricity market. Appellant V adds that netting should in any case not be implemented in the process of flow decomposition of Article 6 of the RDCTCS and should be a distinct step in the cost distribution of Article 7 of the RDCTCS.

634. The formulation of Appellant V's appeal is unclear, especially in the light of its Reply, which contains different arguments¹³⁶. This lack of clarity was raised by ACER's Defence¹³⁷. The Board of Appeal sent out a Second Request for Information in which Appellant V was asked to clarify its Appeal¹³⁸. Appellant V's Response to the Second Request for Information

¹³⁵ Appeal V, Plea 2, Sub-Plea 5, paras 173-178.

¹³⁶ Reply of Appellant V, paras 226, 244 and 245. Its summary of para 226 states: "Netting: ACER adopted an "internal" netting process for the so-called allocated flows (import/export and transit flows, i.e. market flows) as part of the flow decomposition process. However, it refused to allow netting of burdening and relieving flows. This is another incorrect and inconsistently adjusted "lever". The netting of burdening and relieving flows would reduce (loop) flow components taken into account for cost allocation, because - to the extent burdening and relieving loop flows net - loop flows do not contribute to congestions. ACER acknowledges that this is "true [...] from a strict physical reality perspective". Based on this finding, it remains unclear how preventing netting could even "try to reflect as good as possible the physical reality". The decision to deny netting is even more inconsistent, as such netting applies to PST flows and loop flows outside the Core CCR. Further, ACER contradicts its own argumentation with regard to the relevance of the SO Regulation and the ROSC-Methodology. The sole consideration of burdening loop flows implies a higher physical overload than physically detected, which is inconsistent with the ROSC process."

¹³⁷ Defence, para 420: "As the issue regarding the (absence of) netting is not related to Article 6(1) of Annex I of ACER Decision 30/2020 (which only relates to the flow decomposition of each XNEC and for each hour) but is built into Article 7 of Annex I of ACER Decision 30/2020, it is not clear to ACER what the underlying concern is and what is in fact objected by Appellant V. Appellant V does not provide a sufficiently comprehensible claim in its Notice of Appeal on how the netting matter is related to Article 6(1) of Annex I of ACER Decision 30/2020."

¹³⁸ Second Request for Information of the Board of Appeal: "**Question 5 A-001-2021 (cons) To Appellant V:** Please confirm whether Plea 2, Sub-plea 5, paras 173-178, challenges the Contested Decision's RDCTCS because (i) there is no netting process at all in the Contested Decision's RDCTCS; or (ii) there is a netting process in the calculation of the overload in the Contested Decision's RDCTCS; or (iii) the netting process in the calculation of the overload in the Contested Decision's RDCTCS should occur per bidding zone and not per XNEC; or (iv) there should be a netting process of burdening and relieving flows per XNEC in the Contested Decision's RDCTCS when allocating different flows to the overload; or (v) there should be a netting process of burdening and relieving flows per bidding zone in the Contested Decision's RDCTCS when allocating different flows to the overload."

clarifies the scope of its Appeal¹³⁹. Even though Appellant V's Reply and Response to the Second Request for Information manifestly broaden the scope of Appellant V's initial Appeal and should be dismissed, this broader scope is tackled in the Fifth Consolidated Plea because it coincides with the appeal of Appellants IV and VI.

635. Appellant VI¹⁴⁰ claims that Title 3 (cost sharing principles) and in particular Article 7 (distribution of costs on XNECs to TSOs), as well as Article 8 (settlement of costs) of the Contested Decision's RDCTCS are contrary to Articles 16(8) and (13) ER and 74 and 75 CACM. It adds that the different treatment of flows contravenes the principle of non-discrimination and the principle of effective and efficient cost management of the Recitals of the ER and CACM. Appellant VI alleges that a failure to net could lead to an artificial and disproportionate increase in the cost of burdening LFs which would, in turn, disincentive TSOs from investing in their networks to relieve structural congestion.
636. In its Defence¹⁴¹, ACER responds that the Contested Decision's RDCTCS does not include the netting of flow components in the opposite direction to the congestion for the allocation of the different types of flows to the overload because (i) there is no legal obligation to net burdening flows with relieving flows for the allocation of the different types of flows to the overload in the cost sharing solution, (ii) the RDCTCS is in line with the general netting requirement of the principles of CM, (iii) an additional netting process, as suggested by the Appellants, would be in contradiction with 16(13) ER and the PPP because Article 16(13) ER only requires the identification of flows that contribute to the congestion, i.e. burdening flows, whereas relieving flows do not contribute to the congestion and because an artificial reduction of burdening LFs resulting from any netting process would infringe Article 16(13) ER and the PPP, and (iv) an additional netting process would also be in contradiction with the general principles of non-discrimination and with Articles 74(6)(a) and (c) and 3(e) CACM and Article 16(1) ER. In ACER's view, the Contested Decision's RDCTCS is also in line with Article 16(11) ER and Articles 3(f), 74(6)(d)(i) and (f) CACM. ACER's Defence also states that it does not understand Appellant V's claim on the absence of netting in Article 6(1) of the Contested Decision's RDCTCS, because Article 6(1) of the Contested Decision's RDCTCS refers to flow decomposition on XNECs.
637. Interveners II, III, IV, V and VI intervene in the Fifth Consolidated Plea on behalf of the Defendant.

¹³⁹ Appellant V's Response to the Second Request for Information of the Board of Appeal: "TenneT would like to answer as follows: It is not possible to specify one of the options exclusively, because TenneT challenges the Decision out of several reasons and the options provided by the BoA only partially or insufficiently cover TenneT's concerns. Broadly categorized, TenneT raises two major concerns. The first concern relates to the aggregation ("netting") of individual flow types in Article 6(1) RDCTCS methodology for means of flow decomposition, according to which import/export and transit flows are merged into one allocated flow and further to the distinction applied between the origins of flows (Appeal, para. 175). This results in a preselection of flows and flow types for cost-sharing (applied in the step of identifying the causes of flows). For the reasons outlined in the Appeal, such "netting" should therefore only take place on a bidding-zone level and subsequent to the flow decomposition process, i.e. as a distinct the Contested Decision's RDCTCS") and (iii) ("the netting process in the calculation of the overload in the Contested Decision's RDCTCS should occur per bidding zone and not per XNEC") of the BoA question. The second major concern is that ACER unlawfully refrained from adopting any netting of burdening and relieving flows in the contested Decision (Appeal, paras. 174 third sentence et seq., 175, 178; Reply, paras. 226, 244 et seq.). This concern remains relevant even if the BoA rejects the first concern (and thus must also be considered, if, according to the BoA, it is legally sound to exercise any netting on XNEC-level). With regard to the absence of any netting of burdening and relieving flows in the Decision, option (i) ("there is no netting process at all in the Contested Decision's RDCTCS") and (iv) ("there should be a netting process of burdening and relieving flows per XNEC in the Contested Decision's RDCTCS when allocating different flows to the overload") seem to apply. TenneT further clarifies that it limited its reply statement of 14 April 2021 to the second major concern due to the page limitation (Reply, paras. 226, 246 et seq.), but did not waive its first concern or any other concern thereby."

¹⁴⁰ Appeal VI, Plea 3, paras 171-174.

¹⁴¹ Defence, paras 416-430.

638. Title III of the Contested Decision's RDCTCS, entitled "*Cost Sharing Principles*", includes (i) mapping of XRA costs to XNECs in its Article 5, (ii) flow decomposition on XNECs in its Article 6 and (iii) distribution of costs on XNECs to TSOs in its Article 7. It does not contain a separate stage concerning netting burdening flows with relieving flows.
639. Article 2(e) of the Contested Decision's RDCTCS defines a burdening flow as "*a flow identified on a network element in the direction that is aggravating a constraint on that network element*" and Article 2(o) of the Contested Decision's RDCTCS defined a relieving flow as "*a flow identified on a network element in the direction that is relieving a constraint on that network element*".
640. The Contested Decision states the following in section 6.2.2.4 "*Netting of flow components in the opposite direction of the congestion*":
- (103) Article 8(4) of the Proposal specifies that a cost sharing solution must apply the netting of flow components that are opposite to the direction of congestion (i.e. relieving flows), but it does not specify how exactly this netting is applied. In the Experimentation report and Non-paper of Core TSOs, Core TSOs have analysed several solutions that fall into two categories. The first category determines which relieving flows are netted with which burdening flows, and here TSOs presented that first the relieving flows of the same category are netted (e.g. relieving loop flows reduce burdening loop flows) and then the remaining relieving flows, if still present, reduce all burdening flows. The second category determines how flows are netted and here the TSOs presented three solutions: (i) all relieving flows reduce all burdening flows proportionally to the size of burdening flows, (ii) all relieving flows reduce all burdening flows equally, such that each burdening flow component is reduced by the same amount and (iii) vertical shift by which the relieving flows reduce burdening flows at the bottom of the order stack, which is determined by the priorities of flows as determined in Section 4.5 of the TSOs' Explanatory document.*
- (104) After careful analysis of all options presented by the TSOs and the fact that the TSOs could not agree on any of the presented options, ACER concluded that the cost sharing methodology does not require the netting of relieving flows. While netting could technically be applied, the cost sharing methodology can also work without any netting of relieving flows.*
- (105) The reason for such decision is twofold. First, neither the CACM Regulation nor the Electricity Regulation explicitly requires the netting of relieving flows for establishing a cost sharing solution. Second, Article 16(13) of the Electricity Regulation only requires the identification of flows which contribute to congestion as only such flows shall be considered for cost sharing. The flows which contribute to congestion are only burdening flows whereas the relieving flows do not contribute to congestion. Furthermore, reducing burdening flows by the relieving flows would artificially reduce the contribution of burdening flows to congestion and thereby would not comply with the requirements of Article 16(13) of the Electricity Regulation, which require the identification of flows which contribute to congestion without any reductions. For this reason, ACER removed from the cost sharing methodology the requirement to net the relieving flows as it is not required for cost sharing.*
- (106) During the proceedings on this Decision, ACER explored whether regulatory authorities could support the netting of relieving flows in the form of equal netting where the equal share of relieving flows reduce all burdening flow components. The responses from the majority of regulatory authorities showed that a Decision adopted based on such proposal for netting could not receive the required favourable opinion of the ACER's Board of Regulators. Thus, only a Decision where no netting of relieving flows is applied was able to gather the required favourable opinion of the ACER's Board of Regulators."*

5.1 The decision-making process leading-up to the Contested Decision.

641. As will be set out below in the Fourteenth Consolidated Plea, ACER adopted the Contested Decision on the basis of Article 6(10)(a) ACER Regulation and, to this end, it carried out the regulatory supervision of All Core TSOs' RDCTCS Proposal under Article 74 CACM, which stipulates in Article 74(6)(f) that the RDCTCS needs to facilitate adherence to the general principles of CM as set out in Article 16 ER.
642. First, All Core TSOs' RDCTCS Proposal did not specify why and how netting had to be performed.
643. Article 8(4) of All Core TSOs' RDCTCS Proposal contained a netting process of relieving and burdening flows as a first step in the transformation of decomposed flow components into shares (%) for each BZ: "*Netting: a. The flow shares for each flow type shall be either relieving or burdening with respect to the direction of the total flow on a XBRNE. The relieving and burdening flows shall be netted in order to obtain only burdening flow shares for each flow type on a single XBRNE. The result of the netting is the set of netted flow shares for each flow type per bidding zone in [MW] on a XBRNE.*" This netting process was situated after the flow decomposition (Article 7 of the Proposal) and

before the application of a threshold and the prioritisation (respectively Article 8(5) and 8(6) of the Proposal). Burdening flows are flows in the flow direction of the total flow on a congested element, while relieving flows are in the opposite direction.

644. As set out in paragraphs (58) and 62(d) of the Contested Decision, Article 8(4) of All Core TSOs’ Proposal did not specify why and how this netting had to be performed.

645. All Core TSOs’ RDCTCS Explanatory Document¹⁴² set out 5 different types of netting methods in its Section 4.4. “*Netting and scaling of flows*”, as set out below:

Table of the section “Netting and scaling of flows” of All Core TSOs’ Experimentation Report.

Number	Name	Type	Description
1	Proportional netting per category	Netting per category	Net the flows per category proportionally. Relieving flows are distributed proportional with burdening flows within each category, without distinction between bidding zones.
2	Equal netting per category	Netting per category	Net the flows per category equally. Relieving flows are distributed equally to burdening flows without distinction between bidding zones
3	Proportional netting	Netting proportional	Proportional netting without taking into account the categories
4	Proportional netting per category with credit	Netting per category and bidding zone	Netting of flows per category which reward bidding zones causing relieving flows
5	Vertical shift	Netting related to prioritisation	Relieving flows lower the flow on an element. Based on the prioritisation principle the remaining burdening flows above the Fmax are punished

Source: All Core TSOs’ Experimentation Report.

646. All Core TSOs’ Experimentation Report¹⁴³ applied netting option “equal netting per category with credit” for 2 scenarios (yellow and green) and netting option “proportional per category” for another scenario (blue).

647. All Core TSOs’ Non Paper¹⁴⁴ set out that there were 3 preferred netting methods (i) equal netting per category with credit¹⁴⁵; (ii) vertical shift¹⁴⁶ and (iii) proportional netting per category¹⁴⁷.

648. These netting processes were discussed during the consultation between ACER, All Core NRAs and All Core TSOs¹⁴⁸, as well as during the hearing phase of All Core NRAs and All Core TSOs¹⁴⁹. However, neither All Core TSOs nor All Core NRAs agreed on a netting process¹⁵⁰. All Core NRAs’ Non-Paper did not address the issue of netting¹⁵¹.

649. The Board of Appeal concludes that, in carrying out its functions of regulatory supervision, ACER had to take account of the fact that All Core TSOs’ RDCTCS Proposal did not specify why and how netting had to be performed, whilst taking due account of the views of All Core

¹⁴² Annex 13 to the Defence, p. 38.

¹⁴³ Annex 23 to the Defence, p. 15.

¹⁴⁴ Annex 79 to the Defence, p. 12.

¹⁴⁵ Relieving flows are distributed equally to burdening flows within each category, without distinction between bidding zones. In case the burdening flows of a BZ are lower than the share of relieving flows, this remaining share is divided equally between the flows of other BZs.

¹⁴⁶ Burdening flows are prioritised according to the prioritisation principle and thresholds are applied. The relieving flows are netted with the flows starting at the bottom of the stack until all relieving flows are netted.

¹⁴⁷ Relieving flows are distributed proportional with burdening flows within each category, without distinction between BZs.

¹⁴⁸ Contested Decision, para 24.

¹⁴⁹ Contested Decision, para 28.

¹⁵⁰ Contested Decision, paras 104 and 106.

¹⁵¹ Annex A.3.2 to Appeal VI.

NRAAs. ACER had to ensure that All Core TSOs' RDCTCS Proposal complied with the applicable regulatory framework.

650. As will be set out in detail in Sub-Plea 5.2, Article 7(6) of the Contested Decision's RDCTCS contains an implicit netting process with respect to the calculation of the total flow on each NE facing congestion in order to calculate its overload.
651. However, the Contested Decision's RDCTCS does not contain an additional netting process for cost distribution because such additional netting process is not required by Articles 74 CACM and 16 ER and would, on the contrary, infringe Article 16(13) ER and the PPP, as will be explained in detail in Sub-Plea 5.3.
652. Finally, the Board of Appeal notes that ACER has consistently adopted the same approach on netting as regards the RDCTCS for SEE (ACER Decision 31/2020¹⁵²).

5.2 The lack of an additional netting process infringes Article 16(11) ER.

653. Appellant IV alleges that the lack of an additional netting process infringes Article 16(11) ER. It holds that the approach of the Contested Decision's RDCTCS is fictitious because burdening and relieving flows are automatically netted by the laws of physics, resulting in one predominant flow direction per NE. It alleges that, since transmission capacity in the Core CCR is allocated implicitly, flows in the opposite direction are netted by default. Appellant IV adds, in this respect, that, even if the Board of Appeal were to confirm the RDCTCS scope, encompassing interconnection lines and internal lines under some circumstances, the fact that Article 16(11) ER only addresses netting on interconnection lines and not on internal lines should not lead to the conclusion that Article 16(11) ER does not apply to the RDCTCS.
654. Article 16(11) ER reads: "*As far as technically possible, transmission system operators shall net the capacity requirements of any power flows in opposite directions over the congested interconnection line in order to use that line to its maximum capacity. Having full regard to network security, transactions that relieve the congestion shall not be refused.*"
655. A distinction needs to be made between, on the one hand, the calculation of the total flow on each NE facing congestion in order to calculate its overload (the calculation of the overload) and, on the other hand, the distribution of costs of the different types of flows after the said calculation (the allocation of different types of flows to the overload).
656. Article 16(11) ER relates to capacity calculation and not to cost distribution. It concerns the calculation of the overload. It does not concern the allocation of different types of flows to the calculated overload. Article 16(11) ER imposes netting "*in order to use that line to its maximum capacity*". It imposes netting to use lines to their maximum capacity. This requirement relates to capacity calculation and not to cost allocation of the different flow types.
657. In this respect, the Contested Decision's RDCTCS contains an implicit netting process with respect to the calculation of the total flow on each NE facing congestion in order to calculate its overload. This implicit netting process occurs before any flow decomposition by performing a load flow on the CGM pursuant to Articles 18(2)(b) and 19 of the RDCT annexed to ACER Decision 35/2020 as well as Article 18(2)(b) and 19 of the ROSC annexed to ACER Decision 33/2020¹⁵³. Article 18(2)(b) RDCT and Article 18(2)(b) ROSC ("*General provisions of coordination process*") are identical and state: "*The day-ahead CROSA shall include two coordination runs and each intraday CROSA will include at least one coordination run. Each coordination run shall consist of the following steps: (b) Performing the load flow and contingency analysis in accordance with Article 19.*" (emphasis added). Article 19(1) RDCT and Article 19(1) ROSC ("*Operational Security Analysis*") are identical and state: "*Core RSC(s) shall perform the operational security analysis by using the CGM built in accordance with CGMM. The security analysis will be performed*

¹⁵² https://acer.europa.eu/Official_documents/Acts_of_the_Agency/Individual%20decisions/ACER%20Decision%2031-2020%20on%20SEE%20RDCT%20Cost%20Sharing.pdf

¹⁵³ ACER's Response to Second Request for Information of the Board of Appeal, p. 6.

considering the latest contingency list as well as the latest list of XNEs and scanned elements provided by Core TSOs” (emphasis added)

658. The calculation of the total flow in order to determine physical overload on a XNEC is netted by definition because it implies an implicit deduction of the relieving flows. Article 6(7)(b) of the Contested Decision’s RDCTCS states that “for loop flows from each bidding zone in the Core CCR, all contributions from a particular Core bidding zone are summarised for each XNEC” (emphasis added). Per XNEC, the sum of the nodal contributions for LFs and IFs from a BZ is calculated: LFs are identified when the XNEC is not located within the same BZ and can be either negative (relieving) or positive (burdening). Decomposition per flow type is not needed to calculate the total flow. Hence, there is no need to make a distinction between burdening and relieving flow components in the calculation process of the total flow. However, there is an implicit netting process that does not identify which burdening flows are netted with which relieving flows but ensures that all relieving flows reduce all burdening flows¹⁵⁴. The volume of overload can be calculated directly from the load flow on CGM.
659. In the flow decomposition, Article 7(6) of the Contested Decision’s RDCTCS requires Core TSOs to calculate the volume of overload, which shall be equal to the **total flow** on the eligible XNEC before the RAO, reduced by the maximum flow on that XNEC: “In order to identify which flow components contribute to congestion and to which degree, all Core TSOs shall calculate the volume of overload, which shall be equal to the total flow on the eligible XNEC before the RAO, reduced by the maximum flow on that XNEC (..).” “Total flow” is defined in Article 2(2)(w) of the Contested Decision’s RDCTCS as “the flow on a XNEC that can be calculated before the RAO, which is used to identify whether the XNEC is congested or not, or after RAO to verify that the XNEC is not congested anymore. The total flow is calculated in accordance with the methodology pursuant to Article 35 of the CACM Regulation and the methodology pursuant to Article 76 of the SO Regulation.”
660. Consequently, the Contested Decision’s RDCTCS complies with Article 16(11) ER.
661. It is only after the calculation of the overload is done that the calculation of flow components is done. As set out above, the volume of the overload can be calculated directly from the load flow on CGM. However, individual BZ contributions to the overload require flow decomposition or decomposition per flow type.
662. Firstly, Article 6(1) of the Contested Decision’s RDCTCS, entitled “Flow decomposition on XNECs”, calculates on each XNEC the following flow types:
- (a) PST flow, representing the component of physical flow resulting from the effect of using all PSTs located within and outside the Core CCR as determined within the CGM;
 - (b) Allocated flow, representing the component of physical flow resulting from all cross-zonal exchanges within and outside the Core CCR;
 - (c) Loop flow from outside the Core CCR, representing the component of physical flow resulting from internal exchanges within all bidding zones outside Core CCR;
 - (d) Loop flow for each bidding zone in the Core CCR, representing the component of physical flow resulting from internal exchanges within each bidding zone within the Core CCR; and
 - (e) Internal flow, in case the eligible XNEC is an internal network element, representing the component of physical flow resulting from internal exchanges within the bidding zone where an XNE is located.” (emphasis added)
663. Secondly, Article 7(6) of the Contested Decision’s RDCTCS proceeds to list how flows are stacked on top of each other according to a prioritisation order when it is decided which flows cause a congestion on a XNEC, as will be set out in detail in the Sixth Consolidated Plea. This stack applies to determine the TSOs’ contribution to the XRA costs necessary to relieve physical congestion (overload) on the relevant XNEC:
- (1) burdening Core LFs above threshold;
 - (2) burdening IFs;
 - (3) burdening LFs outside Core;
 - (4) burdening Core LFs below the individual threshold;
 - (5) burdening AFs; and
 - (6) burdening PST flows.
664. ACER has provided an illustration in its Rejoinder as follows:

¹⁵⁴ ACER’s Response to Second Request for Information of the Board of Appeal, p. 7.

Table – Numerical Example of the Cost Sharing Methodology of ACER Decision 30/2020

BASIC EXAMPLE		DATA:	NETTING: (None)	APPLY THRESHOLD: (floating individ. thr. for LFs; their sum = comm.thr.)			SOCIALISATION: (none)	POLLUTERS: (Priority: First Core LF>thr, then IF)	
Source	Type of flow	Flows (%/Fmax)	Flow reduction	Core LFs below individual threshold	Core LFs above individual threshold	Core LFs above individual threshold	LF/IF above thr, socialisation (%/Fmax)	Polluter flows (%/Fmax)	Polluter shares (%)
Common	Fmax	100							
Common	PST flow	-7	0,000	0,000	0,000	0,000	0	0	0
Common	Market flow (all CCRs)	59	59,000	59,000	59,000	59,000	0	0	0
Common	LFs from other CCRs	2	2,000	2,000	2,000	2,000	0	0	0
B21	IF	51	51,000	51,000	51,000	51,000	51,000	3,000	8,57%
B22	LF	-4	0,000	0,000	0,000	0,000	0,000	0,000	0,00%
B23	LF	-1	1,000	1,000	1,000	0,000	0,000	0,000	0,00%
B24	LF	15	15,000	2,000	2,250	12,750	12,750	12,750	36,43%
B25	LF	8	8,000	2,000	2,250	5,750	5,750	5,750	16,43%
B26	LF	13	13,000	2,000	2,250	10,750	10,750	10,750	30,71%
B27	LF	5	5,000	2,000	2,250	2,750	2,750	2,750	7,86%
B28	LF	-8	0,000	0,000	0,000	0,000	0,000	0,000	0,00%
SUM	Total loading	135	154	9,000	10,000	32,000	83,000	35,000	100,00%

NETTING	APPLY THRESHOLD	SOCIALISATION	POLLUTERS
No netting	Common thr: 10 No. Items: 5 Individual thr: 2,000 Iteration 1: 2,250 Iteration 2: 2,250	Other LFs: 0,000 No. Items: 5 Amount: 0,0000	Overload: 35 LFabove: 32,000 LFCoeff: 1,00000 Remaining: 3,000 IFabove: 51,000 IFCoeff: 0,05882 Remaining: 0,000

ADOPTED FOR CORE AND SEE:
 MAPPING: Least Cost Based Mapping (LCBM)
 FLOW DECOMPOSITION: PPC
 COMMON THRESHOLD: 10%, applied only on intra-CCR LFs
 INDIVIDUAL THRESHOLD: dynamic, up to common thr.
 NETTING: NO NETTING
 SOCIALISATION: NO SOCIALISATION (OWNER PAYS)
 POLLUTERS:
 1st: LFs above threshold
 2nd: IF (practically owner pays for all possible rest)

Source Annexes 92 and 93 to ACER’s Rejoinder.

665. The illustration in ACER’s Rejoinder demonstrates that there are, on the one hand, burdening flows representing 154% of the Fmax of the relevant XNEC (154%= 32% burdening LFS above the threshold; 51% burdening IFs from the BZ where the XNEC is located; 2% burdening LFs from outside Core; 10% burdening LFs below the threshold; 59% burdening AFs from all CCRs; 0% PST flows from all CCRs) and, on the other hand, relieving flows representing -19% of the Fmax of the relevant XNEC (relieving PST flows of -7% from the effect of using all PSTs located within and outside Core; relieving LFs of -4%; relieving flows of -8%). A comparison with the total flow of 135% on the relevant XNEC demonstrates that the total flow is equal to the sum of the burdening flows (154%) and relieving flows (-19%). In the numerical example, RAs are taken to relieve congestion (overload) of only 35% and the costs are distributed for 32% to BZs having burdening LFs above the threshold and for 3% to the BZ where the XNEC is located because of burdening IFs.

666. Appellants IV and VI claim that the RDCTCS does not contain any netting process is, therefore, incorrect. The Contested Decision’s RDCTCS contains an implicit netting process with respect to the calculation of the total flow on each NE facing congestion in order to calculate its overload.

667. Article 16(11) ER does not require an additional netting process for cost distribution with respect to the different types of flows in the RDCTCS. Moreover, an additional netting process for the cost distribution would infringe Article 16(13) ER and the PPP.

668. As set out above, the Contested Decision’s RDCTS does not contain any additional netting of LFS for the cost distribution process among Core BZs. On a XNEC for which the costs of the RAs need to be shared, the relieving LFs of one BZ do not reduce the burdening LFs of another BZ. As set out by ACER in its Rejoinder: “Therefore, for a XNEC, it is only if (i) the LFs from a neighbouring BZ is positive (burdening), and (ii) the level of its LFs is above the legitimate individual threshold, that this (neighbouring) BZ will contribute to the costs for relieving the congestion on this XNEC. On the other hand, if a (neighbouring) BZ has relieving LFs, it will bear no cost, as it does not contribute to the congestion as stipulated by Art. 16(13) of Electricity Regulation.”¹⁵⁵

¹⁵⁵ Rejoinder, para 7.

5.3 The lack of an additional netting process infringes Article 16(13) ER and the PPP.

669. Appellants IV, V and VI allege that the lack of an additional netting process infringes Article 16(13) ER and the PPP.
670. Article 16(13) ER states: “When allocating costs of remedial actions between transmission system operators, regulatory authorities shall analyse to what extent flows resulting from transactions internal to bidding zones contribute to the congestion between two bidding zones observed, and allocate the costs based on the contribution to the congestion to the transmission system operators of the bidding zones creating such flows except for costs induced by flows resulting from transactions internal to bidding zones that are below the level that could be expected without structural congestion in a bidding zone. That level shall be jointly analysed and defined by all transmission system operators in a capacity calculation region for each individual bidding zone border, and shall be subject to the approval of all regulatory authorities in the capacity calculation region.”
671. Article 16(13) ER requires that the RDCTCS determines flows which contribute to congestion for allocation purposes, i.e. to include them in cost sharing. Only burdening flows are flows that are responsible for and, hence, contribute to congestion. Article 16(13) ER requires that burdening flows be identified for their subsequent allocation to the overload. Relieving flows do not contribute to congestion.
672. There is no need for an additional netting process. If LFs from a (neighbouring) BZ are not burdening, then a BZ is not penalised as it does not contribute to the cost-sharing, and it is not rewarded either. As set out by ACER in its Rejoinder¹⁵⁶, this is the reason why in the cost sharing process, the contribution to the overload of a BZ with relieving LFs (and consequently its cost share) is equal to 0%. This approach also implies that these relieving LFs do not benefit other BZs. These relieving LFs are thus not used to reduce the burdening LFs of other BZs.
673. An additional netting process, which would reduce burdening flows by relieving flows when allocating different types of flows to the overload, would reduce the contribution of burdening flows to the overload and, hence, distort the cost distribution set by Article 16(13) ER. As set out in ACER’s Defence, it would allow some burdening LFs to escape the PPP even though they are above the legitimate LF threshold, while the objective of the RDCTCS is to incentivise TSOs of BZs causing the LFs to take measures to reduce LFs in general (be they burdening or relieving)¹⁵⁷. An additional netting process would, in other terms, allow and not penalise certain LFs above the threshold. This would be contrary to the PPP. This would also go counter Recital (27) ER: “(..) Clear minimum levels of available capacity for cross-zonal trade need to be put in place in order to reduce the effects of loop flows and internal congestions on cross-zonal trade and to give a predictable capacity value for market participants(..)”. It would, finally, be inconsistent with other sections of the Contested Decision’s RDCTCS that are rooted in the PPP.
674. In accordance with Article 16(13) ER and the PPP, costs are allocated to the TSOs causing the congestion on the basis of the burdening flows for which they are responsible. Each BZ is held accountable for its own level of LFs on a XNEC when the sum of these LFs is positive or burdening. Consequently, the costs to be borne by each BZ are allocated to the extent of its actual and entire contribution to the congestion, and no artificial reduction of its burdening LFs with the relieving LFs of another BZ is done through an additional netting process.
675. Importantly, the Board of Appeal notes that an additional netting process when allocating different types of flows to the overload would jeopardise the *effet utile* of the entire methodology, as it would render the legitimate LF threshold and the stacking/prioritisation of flows redundant. In that respect, such additional process would infringe Article 16(13) ER to the extent that it would *de facto* annihilate the legitimate LF threshold, which is mandatory under Article 16(13) ER.

¹⁵⁶ Rejoinder, para 7.

¹⁵⁷ Defence, para 424.

5.4 The lack of an additional netting process infringes Article 74(6)(a) CACM.

676. Appellant VI claims that the lack of an additional netting process could lead to an artificial increase in the cost of burdening LFs, which, in turn, would disincentivise TSOs from investing in their networks to relieve structural congestion, as they are required to do under the ER, because the costs of internal commercial flows would be put disproportionately on to LFs.
677. Appellant V alleges that the netting approach of the Contested Decision's RDCTCS infringes Article 74(6)(a) CACM because it does not provide correct investment incentives to Core TSOs.
678. Article 74(6)(a) CACM requires the RDCTCS to "(a) provide incentives to manage congestion, including remedial actions and incentives to invest effectively".
679. Article 16(1) ER states "Network congestion problems shall be addressed with non-discriminatory market-based solutions which give efficient economic signals to the market participants and transmission system operators involved. Network congestion problems shall be solved by means of non-transaction-based methods, namely methods that do not involve a selection between the contracts of individual market participants. When taking operational measures to ensure that its transmission system remains in the normal state, the transmission system operator shall take into account the effect of those measures on neighbouring control areas and coordinate such measures with other affected transmission system operators as provided for in Regulation (EU) 2015/1222."
680. Recital (34) ER states: "The management of congestion problems should provide correct economic signals to transmission system operators and market participants and should be based on market mechanisms."
681. As set out above, an additional netting process would allow some burdening LFs to escape the PPP even though they are above the legitimate LF threshold. This would provide the wrong incentives to Core TSOs causing LFs not to take measures to reduce LFs in general (be they burdening or relieving). As set out in ACER's Defence, Core TSOs "could be brought to believe that the flows that they are causing could be used as relieving flows, which is in fact not the case because their flows are first and foremost loop flows which could cause a congestion in other circumstances."¹⁵⁸ TSOs should instead be incentivised to reduce the creation of LFs by means of appropriate measures and network infrastructure investments.

5.5 The lack of an additional netting process infringes Article 74(6)(b) CACM.

682. Appellant IV alleges that TSOs' responsibilities and liabilities involve, *inter alia*, their responsibilities to comply with Article 16(11) and (13) ER.
683. Appellant IV claims that Article 16(11) ER requires Core TSOs to net the capacity requirements of all power flows in opposite directions (regardless of whether they are LFs or AFs) over congested interconnection lines in order to use those lines to their maximum capacity as far as technically possible. It holds that the only prerequisite which the Core TSOs have to comply with, is that the maximum capacity of the NE in question (in the sense of Article 16(8) ER, in conjunction with Article 15(2) ER as the case may be) may be used for the transmission of electricity for the purpose of fulfilling CB trade transactions. In its view, Core TSOs bear a responsibility, under Article 16(11) ER not to refuse transactions that relieve the congestion, i.e. not to refuse relieving AFs, except if such refusal is justified by network security.
684. Appellant IV claims that Article 16(13) ER requires Core NRAs to apply a verification standard when allocating costs of RAs between TSOs. Core NRAs need to analyse to what extent flows resulting from transactions internal to BZs contribute to the congestion between 2 BZs observed, i.e. LFs, and allocate the costs based on the contribution to the congestion by the TSOs of the BZ creating such flows, except for costs induced by flows resulting from transactions internal to BZs that are below the level that could be expected without structural congestion in a BZ. Appellant IV draws an analogy with damages claims, whereby compensations are netted to avoid overcompensation.

¹⁵⁸ Defence, para 426.

685. Appellant IV also claims that the reliance on gross LFs instead of net LFs in the absence of netting over-penalises LFs by requiring Core TSOs to fictitiously assume that there are no relieving flows reducing the gross LF into a net LF, whereas they exist in reality. In its view, demanding in a legally binding decision that Core TSOs act on the basis of a non-existent factual situation not only ignores but also contravenes the consistency criteria established in Article 74(6)(b) CACM.
686. Article 74(6)(b) CACM requires the RDCTCS to “(b) be consistent with the responsibilities and liabilities of the TSOs involved”.
687. The Contested Decision’s RDCTCS is in line with the responsibilities and liabilities of Core TSOs. As set out above in Sub-Pleas 5.1 and 5.2, the Contested Decision’s RDCTCS does not infringe Article 16(11) and (13) ER.
688. In accordance with Article 16(13) ER and the PPP, costs are allocated to the TSOs causing the congestion on the basis of the burdening flows for which they are responsible. Also, the absence of an additional netting process when allocating flows to the overload provides the correct incentives to TSOs: they are incentivised to reduce the creation of LFs by means of appropriate measures and network infrastructure investments.
689. Appellant IV’s analogy with compensations for damages is not relevant because, as will be set out below in Sub-Plea 5.13, compensation mechanisms have to be distinguished from cost sharing methodologies.

5.6 The lack of an additional netting process infringes Article 74(6)(c) CACM.

690. Appellant IV claims that the Contested Decision’s RDCTCS infringes Article 74(6)(c) CACM because it does not create a fair cost sharing methodology for LF polluters, which are over-penalised.
691. Article 74(6)(c) CACM requires the RDCTCS to “(c) ensure a fair distribution of costs and benefits between the TSOs involved”.
692. The Contested Decision’s RDCTCS provides a fair cost sharing methodology. In accordance with the PPP, Core TSOs causing flows contributing to congestion are asked to pay for the overload. As set out above in Sub-Plea 5.3, the Contested Decision’s netting approach does not imply an over-penalisation of Core TSOs causing LFs and ensures a fair distribution of costs and benefits to Core TSOs.
693. Importantly, an additional netting process for the cost allocation under the Contested Decision’s RDCTCS would alter the priority stack of flow components. As set out by ACER in its Rejoinder¹⁵⁹, in case a netting solution were to be applied, it is not automatically given that relieving LFs would net burdening LFs of other BZs; they could also relieve IFs, PST flows or AFs. Therefore, a trade-off would be necessary in order to decide which burdening type of flows is to be netted. There is no legal provision or law of physics that would require granting priority in netting to LFs over other flows, *i.e.*, IFs, PST flows, AFs. Deciding that relieving LFs from a BZ would net burdening LFs from another BZ would imply a different priority of flows than the one applied for identifying the contribution to congestion.

5.7 The lack of an additional netting process infringes Article 74(6)(e) CACM.

694. Appellant V alleges that the netting approach of the Contested Decision’s RDCTCS infringes Article 74(6)(e) CACM. It holds that wrong investment incentives to Core TSOs will, in the long run, jeopardise an efficient long-term development of the EU grid and electricity market.
695. Article 74(6)(e) CACM requires the RDCTCS to “(e) facilitate the efficient long-term development and operation of the pan-European interconnected system and the efficient operation of the pan-European electricity market”.
696. Given that the Contested Decision’s RDCTCS provides the correct incentives to Core TSOs to reduce the creation of LFs by means of appropriate measures and network infrastructure

¹⁵⁹ Rejoinder, para 7.

investments, it will not have negative effects on the EU grid and electricity market in the long run as alleged by Appellant V.

5.8 The lack of an additional netting process infringes Article 74(6)(f) CACM.

697. Appellant IV claims that the Contested Decision's RDCTCS infringes Article 74(6)(f) CACM read jointly with Article 16(11) ER. It claims that the Contested Decision's RDCTCS should facilitate adherence to the general principles of CM as set out in Article 16 ER but that the Contested Decision's RDCTCS fails to do so because it infringes Article 16(11) ER.
698. Article 74(6)(f) CACM requires the RDCTCS to "*(f) facilitate adherence to the general principles of congestion management as set out in Article 16 of Regulation (EC) No 714/2009*".
699. As set out above in Sub-Plea 5.2, the Contested Decision's RDCTCS does not infringe Article 16(11) ER. Furthermore, the absence of an additional netting process when allocating flows to the overload aims at ensuring adherence to the general principles of CM of Article 16 ER, in particular Article 16(13) ER and the PPP, as set out in Sub-Plea 5.3.

5.9 The lack of an additional netting process infringes Articles 74(6)(i), 74(5)(e) and 3(f) CACM.

700. Appellant V claims that the netting approach of the Contested Decision's RDCTCS infringes Articles 74(6)(i), 74(5)(e) and 3(f) CACM because the results of the RDCTCS are not transparent and because they disable Core NRAs to undertake significant monitoring of the Core CCR as regards the causes or origins of physical congestions on NEs due to the unrealistic assumption applied.
701. Article 74(6)(i) CACM requires the RDCTCS "*(i) to comply with the principles of transparency and non-discrimination*".
702. Article 74(5)(e) CACM requires the RDCTCS to include "*(e) a process allowing monitoring of each capacity calculation region by the competent regulatory authorities*".
703. Article 3(f) CACM contains the CACM objective of "*ensuring and enhancing the transparency and reliability of information*".
704. The Contested Decision's netting approach is a methodological choice which is neither less transparent nor less auditable than any other methodological choice. Appellant V does not evidence how the Contested Decision's netting approach disables Core NRAs to duly monitor congestion causes on NEs. On the contrary, the fact that there is netting of relieving and burdening flows when calculating the overload but no additional netting when allocating the distinct types of flows to the overload enhances the level of transparency and reliability of the information.

5.10 The lack of an additional netting process infringes Article 16(8) ER.

705. Appellant VI claims that the lack of an additional netting process infringes Article 16(8) ER. It does not, however, provide any detail of said infringement.
706. Article 16(8) ER states: "*Transmission system operators shall not limit the volume of interconnection capacity to be made available to market participants as a means of solving congestion inside their own bidding zone or as a means of managing flows resulting from transactions internal to bidding zones. Without prejudice to the application of the derogations under paragraphs 3 and 9 of this Article and to the application of Article 15(2), this paragraph shall be considered to be complied with where the following minimum levels of available capacity for cross-zonal trade are reached:*
- (a) for borders using a coordinated net transmission capacity approach, the minimum capacity shall be 70 % of the transmission capacity respecting operational security limits after deduction of contingencies, as determined in accordance with the capacity allocation and congestion management guideline adopted on the basis of Article 18(5) of Regulation (EC) No 714/2009;*
- (b) for borders using a flow-based approach, the minimum capacity shall be a margin set in the capacity calculation process as available for flows induced by cross-zonal exchange. The margin shall be 70 % of the capacity respecting operational security limits of internal and cross-zonal critical network elements, taking into account contingencies, as determined in accordance with the capacity allocation and congestion management guideline adopted on the basis of Article 18(5) of Regulation (EC) No 714/2009.*

The total amount of 30 % can be used for the reliability margins, loop flows and internal flows on each critical network element.”

707. Article 16(8) CACM relates to the maximisation of CZC.

708. The lack of an additional netting process in the Contested Decision’s RDCTCS does not infringe Article 16(8) CACM.

5.11 The lack of an additional netting process infringes Article 74(6)(d) CACM.

709. Appellant IV claims that the Contested Decision’s RDCTCS infringes Article 74(6)(d) CACM because it is inconsistent with the ITC of Article 49 ER and Regulation (EU) 838/2010.

710. Article 74(6)(d) CACM requires the RDCTCS to “*be consistent with other related mechanisms, including at least: (i) the methodology for sharing congestion income set out in Article 73; (ii) the inter-TSO compensation mechanism, as set out in Article 13 of Regulation (EC) No 714/2009 and Commission Regulation (EU) No 838/2010 (1)*”.

711. Appellant IV claims that Article 74(6)(d) CACM expressly refers to consistency with the ITC and that the absence of netting in the Contested Decision’s RDCTCS is not consistent with the ITC. In its view, eligible costs for compensation under the ITC are only costs that are actually incurred. It claims that, by contrast, under Article 7 of the Contested Decision’s RDCTCS, eligible costs are fictitious gross LFs, which physically do not exist (those LFs correspond, in reality, with a lower amount of net LFs due to the physical reality and legal obligation to net the burdening flows with relieving flows). Appellant IV also claims that, under the ITC, the factual basis to compensate costs as a result of hosting CB electricity flows amounts to actually occurred and measurable flows. It claims that, by contrast, the gross LFs determined by Article 7 of the Contested Decision’s RDCTCS cannot be measured because the laws of physics lead to an immediate netting of the burdening LFs with the relieving flows so that only net LFs actually occur and can be measured.

712. Article 49(1), (3) and (5) ER states:

“1. Transmission system operators shall receive compensation for costs incurred as a result of hosting cross-border flows of electricity on their networks”.

“3. Compensation payments shall be made on a regular basis with regard to a given period in the past. Ex-post adjustments of compensation paid shall be made where necessary, to reflect costs actually incurred. The first period for which compensation payments are to be made shall be determined in the guidelines referred to in Article 61.

“5. The magnitude of cross-border flows hosted and the magnitude of cross-border flows designated as originating or ending in national transmission systems shall be determined on the basis of the physical flows of electricity actually measured during a given period.”

713. First, as has been set out above in Sub-Plea 5.2, Article 7(6) of the Contested Decision’s RDCTCS contains a netting process with respect to the calculation of the total flow on each NE facing congestion in order to calculate its overload.

714. Second, the ER expressly requires a netting process in the ITC, as per Article 49(5) ER, whereas neither the CACM nor the ER require an additional netting process for cost distribution according to the RDCTCS.

715. Third, the requirement of consistency of the RDCTCS with the ITC does not imply that the RDCTCS should follow all methodological steps of the ITC, because both procedures pursue different goals and have a different legal basis. The ITC is not a regional cost sharing methodology following a bottom-up, multipartite decision-making process but an EU-wide mechanism to compensate costs incurred by TSOs as a result of hosting CB flows of electricity on their networks based on Article 49 ER of Chapter V “*Transmission System Operation*” of the ER. The Contested Decision’s RDCTCS is a methodology to share costs of XRAs following a regionally coordinated identification of costly XRAs to solve physical congestion at Core level, based on Article 74 CACM of Chapter II “*Redispatching and countertrading cost sharing methodology for single day-ahead and intraday coupling*” of the CACM, adopted following a bottom-up, multipartite decision-making process.

716. The fact that the ER requires All TSOs in the EU to net when compensating physical CB flows that they hosted or caused cannot entail that a regional cost sharing methodology following a coordination of costly XRAs to solve physical congestion needs to contain an additional netting process when allocating the different types of flows to the overload, especially when neither the CACM nor the ER so require. There is a conceptual difference between a compensation mechanism and a regional cost sharing methodology, as both pursue different goals. On the one hand, a compensation mechanism compensates for the fact that a TSO was unable to fully use its network when hosting CB flows originating from another TSO, regardless of congestions. On the other hand, a cost sharing solution for costly XRAs pursuant to congestions aims at providing correct incentives to manage congestion, being consistent with the responsibilities and liabilities of the TSOs involved in the region, ensuring a fair distribution of costs and benefits between the TSOs of the region, facilitating efficient long-term development and operation of the EU interconnected system and the efficient operation of the EU electricity market, facilitating adherence to the general principles of CM of Article 16 ER (*inter alia* taking account of the effect of the RDCTCS on neighbouring control areas and coordinating such measures with other TSOs and complying with the PPP), allowing reasonable financial planning, being compatible across DA and ID market-timeframes and complying with the principles of transparency and non-discrimination.

5.12 Appellant V's challenge of Article 6(1) of the Contested Decision's RDCTCS.

717. Appellant V claims that the netting provisions set out in Article 6(1) of the Contested Decision's RDCTCS infringe the ER and the CACM.

718. Article 6(1) of the Contested Decision's RDCTCS reads as follows: "*All Core TSOs shall calculate at least for each XNEC with attributed costs pursuant to Article 5(5) and for each hour the following components of flows, which shall be used for cost sharing:*

(a) *PST flow, representing the component of physical flow resulting from the effect of using all PSTs located within and outside the Core CCR as determined within the CGM;*

(b) *Allocated flow, representing the component of physical flow resulting from all cross-zonal exchanges within and outside the Core CCR;*

(c) *Loop flow from outside the Core CCR, representing the component of physical flow resulting from internal exchanges within all bidding zones outside Core CCR;*

(d) *Loop flow for each bidding zone in the Core CCR, representing the component of physical flow resulting from internal exchanges within each bidding zone within the Core CCR; and*

(e) *Internal flow, in case the eligible XNEC is an internal network element, representing the component of physical flow resulting from internal exchanges within the bidding zone where an XNE is located.*

Article 6(1) of the Contested Decision's RDCTCS does not contain any netting provisions.

719. It concerns the decomposition of flows on XNECs.

720. Article 6(1) aggregates individual flows per flow type and XNEC.

721. Appellant V claims that the aggregation should take place per BZ and not per XNEC. It claims that, by aggregating all individual contributions (burdening and relieving) of the respective flow types per XNEC, Article 6(1) of the Contested Decision's RDCTCS excludes LFs caused by Core BZs. Appellant V claims that this approach is contrary to the purpose of cost sharing, i.e. costs are not assigned to individual power plants but to the TSOs operating the respective BZs. Appellant V refers to the Recommendation for cost-sharing principles by European Network of Transmission System Operators ("ENTSO-E") of 18 October 2017¹⁶⁰ in order to sustain that the Contested Decision's RDCTCS leads to a counterfactual situation whereby positive LFs are not charged up against, for instance, negative transit flows, although there is just one physically inexistent electricity flow. It holds that ENTSO-E recommends that "*the flows refer only to net flows for each category, where only burdening flows are taken into account for cost sharing*"¹⁶¹. In its Response to the Second Request for Information of the Board of Appeal, Appellant V clarifies its argument as follows: "*The first concern relates to the aggregation ("netting")*

¹⁶⁰ Annex 31 to Appeal V.

¹⁶¹ Annex 31 to Appeal V, p. 17, footnote 19.

of individual flow types in Article 6(1) RDCTCS methodology for means of flow decomposition, according to which import/export and transit flows are merged into one allocated flow and further to the distinction applied between the origins of flows (Appeal, para. 175). This results in a preselection of flows and flow types for cost-sharing (applied in the step of identifying the causes of flows). For the reasons outlined in the Appeal, such "netting" should therefore only take place on a bidding-zone level and subsequent to the flow decomposition process, i.e. as a distinct the Contested Decision's RDCTCS") and (iii) ("the netting process in the calculation of the overload in the Contested Decision's RDCTCS should occur per bidding zone and not per XNEC") of the BoA question."

722. As will be set out below in the Fourteenth Consolidated Plea, ACER adopted the Contested Decision on the basis of Article 6(10)(a) ACER Regulation and, to this end, it carried out the regulatory supervision of All Core TSOs' RDCTCS Proposal under Article 74 CACM, which stipulates in Article 74(6)(f) that the RDCTCS needs to facilitate adherence to the general principles of CM as set out in Article 16 ER.
723. All Core TSOs' RDCTCS Proposal stated in its Article 7, entitled "*Flow decomposition*", that "1. The flow decomposition calculation shall identify for each congested XBRNE, for which remedial actions have been activated, the following flow types: i. Loop flows; ii. Internal flows; iii. Import/Export flows; iv. Transit flows; v. PST flows." (emphasis added). All Core TSOs' RDCTCS Explanatory Document¹⁶² set out that "flow decomposition methods will identify the types of flows on each network element that is considered for cost sharing" (emphasis added). All Core TSOs' Non Paper¹⁶³ similarly stated that "when using a flow decomposition to determine the causes of flows on a network element, these flows are identified as burdening or relieving flows".
724. The Contested Decision's RDCTCS therefore reproduces All Core TSOs' RDCTCS Proposal in this respect.
725. Furthermore, the RDCTCS is a regional cost sharing solution adopted at Core level. It aims at coordinating the Core region and does not aim at differentiating between BZs within the region. A cost sharing methodology which would differentiate between control areas or BZs would go counter the objective of regional coordination.
726. In addition, netting at BZ level instead of XNEC level would not be in line with Article 16(13) ER and, in particular, the PPP, because it would render it more difficult to identify which Core TSOs cause congestion and hold them accountable. Flow decomposition per XNEC is precisely aimed at applying the PPP when determining which flows are eligible to contribute to cost sharing. An aggregation at BZ level would also merge XNECs owned by different Core TSOs, which would distort Core TSOs' responsibilities in cost sharing.
727. Appellant V claims that the aggregation per XNEC infringes Articles 74(6)(i) and 3(e) CACM as it unduly discriminates LFs. This is because the exclusion of flow types will treat the causers of flows on a XNEC unequally. Appellant V illustrates this by stating that a power plant in a BZ might cause burdening LFs on a XNEC whereas another power plant of the same BZ might cause relieving LFs on another XNEC. Due to a lack of netting at BZ level, the TSO owning the XNEC with the burdening LF will be asked to pay costs. All options foreseen in ENTSO-E's recommendation for cost-sharing principles of 18 October 2017 treat all burdening and relieving flows equally.
728. Article 74(6)(i) CACM requires the RDCTCS "(i) to comply with the principles of transparency and non-discrimination".
729. Article 3(e) CACM contains the CACM objective of "ensuring fair and non-discriminatory treatment of TSOs, NEMOs, the Agency, regulatory authorities and market participants".
730. As set out above, even though the cost sharing methodology needs to take due account of the zonal model, a cost sharing solution that would differentiate between BZs would go counter the objective of regional coordination. It would also introduce discrimination between large BZs, which would be able to aggregate flows from a large number of XNECs, and smaller BZs, which would only be able to aggregate flows from a more limited number of XNECs. As set out above, an aggregation per BZ would infringe the PPP. As also set out in Sub-Plea 5.3,

¹⁶² Annex 13 to the Defence, p. 45.

¹⁶³ Annex 79 to the Defence, p. 12.

the Contested Decision's netting approach when calculating the overload is fully in accordance with Article 16(13) ER and the PPP. With respect to Appellant V's example, it suffices to state that the Contested Decision's netting approach correctly incentivises Core TSOs to avoid the creation of LFs by means of appropriate measures and network infrastructure investments. Netting at BZ level would dilute or otherwise distort the accountability of TSOs causing congestion and, hence, not provide the correct incentives to invest in infrastructure.

731. The Contested Decision's netting approach, which contains a netting process when calculating the overload, ensures that no discrimination arises between Core TSOs.
732. Appellant V claims that the aggregation per XNEC infringes Articles 74(6)(i), 74(5)(e) and 3(f) CACM because the results of the RDCTCS are not transparent and because they disable Core NRAs to undertake significant monitoring of the Core CCR as regards the causes or origins of physical congestions on NEs due to the unrealistic assumption applied.
733. Article 74(5)(e) CACM requires the RDCTCS to include "*(e) a process allowing monitoring of each capacity calculation region by the competent regulatory authorities*".
734. Article 74(6)(i) CACM requires the RDCTCS "*(i) to comply with the principles of transparency and non-discrimination*".
735. Article 3(f) CACM contains the CACM objective of "*ensuring and enhancing the transparency and reliability of information*".
736. As set out above, the Contested Decision's netting approach is a methodological choice which is neither less transparent nor less auditable than any other methodological choice. Yet an aggregation of flow types per BZ would render it for Core TSOs and Core NRAs more difficult to identify the causes of the congestion, as required by Article 16(13) ER. An aggregation of flow types at BZ level would decrease the level of accuracy and transparency regarding Core TSOs causing the congestion. This would hinder a due application of the PPP and give wrong signals as regards Core TSOs' investments.
737. Appellant V alleges that the netting approach of the Contested Decision's RDCTCS infringes Article 74(6)(e) CACM. It holds that wrong investment incentives to Core TSOs will, in the long run, jeopardise an efficient long-term development of the EU grid and electricity market. Appellant V illustrates this as follows: if a congested DE-NL XNEC is structurally exposed to DE-BE and/or DE-FR exchanges, the RDCTCS needs to provide relevant information on the most efficient investments to solve the specific DE-NL XNEC, e.g. not only investments by DE or NL TSOs but also investments to increase CZC between DE-BE and/or DE-FR.
738. Article 74(6)(e) CACM requires the RDCTCS to "*(e) facilitate the efficient long-term development and operation of the pan-European interconnected system and the efficient operation of the pan-European electricity market*".
739. As set out above, an aggregation per BZ would go counter the essence of the RDCTCS, aimed at coordination at regional level. This would infringe the CACM objectives in relation to cost sharing. It would additionally introduce discrimination within Core CCR, provide the wrong incentives to Core TSOs and infringe Article 16(13) ER and the PPP.
- 740. It follows that the Fifth Consolidated Plea must be dismissed as unfounded.**
741. Appellants' claims on an infringement of the principle of proportionality are dealt with in the Eleventh Consolidated Plea.
742. Appellants' claims on an infringement of the principle of non-discrimination are dealt with in the Twelfth Consolidated Plea.
743. Appellants' claims on ACER's competence are dealt with in the Fourteenth and Fifteenth Consolidated Pleas.

Sixth Consolidated Plea – Priority of loop flows above the threshold.

744. Appellant II¹⁶⁴ claims that by prioritising LFs over IFs in the determination of the contribution of polluting flows to congestion, the Contested Decision violates Recital (27) and Article 16(8) and (13) ER and Articles 3(g) and 74(6)(a) and (b) CACM. In Appellant II's view internal BZ flows are polluting flows, regardless of whether they are LFs or IFs (which sometimes contribute in volume to a larger extent than LFs). Appellant II alleges that prioritising LFs over IFs is not in accordance with the responsibilities and liabilities of TSOs, does not provide sufficient incentives to take adequate operational and investment measures for countries with high IF levels, and is, in the long run, detrimental to achieving the internal electricity market.
745. Appellant III¹⁶⁵ claims that the prioritisation of LFs above the common threshold of 10% is unlawful because LFs are considered as primary contributors to the congestion. It stresses that the prioritisation of LFs above the threshold lacks a legal basis, violates Article 74(6)(a) and (b) CACM, discriminates against larger BZs and goes counter the promotion of renewable energy.
746. Appellant IV¹⁶⁶ opposes the fact that TSOs from whose BZ LFs originate have to bear a part of the costs induced by IFs that occur on the NEs of a TSO of another BZ because those IFs are, in its opinion, not caused by the LF polluting TSOs but by internal trading within the BZ where the congested NE is located. It alleges (i) a lack of consistency with the PPP and the LF verification standard, (ii) a lack of consistency with the LF contribution and PPP under the SO, (iii) an infringement of the requirement to facilitate adherence to the LF contribution verification standard and the PPP, (iv) an infringement of the fair distribution of costs principle, (v) a violation of the principle of non-discrimination, (vi) incoherence with the responsibility of the TSOs to use parts of the capacity for LFs and IFs alike, (vii) an infringement of the requirement to provide incentives to the TSOs to invest effectively, (viii) an infringement of the requirement to give efficient economic signals addressing network congestions, (ix) a violation of the transparency principle, (x) a violation of the requirement to limit the cost-sharing solutions to actions of cross-border relevance and (xi) an infringement of the principle of conferral.
747. Appellant VI¹⁶⁷ claims that he prioritisation of LFs above the threshold breaches the principles of non-discrimination and proportionality in the interpretation and application of Articles 16 ER and 74 CACM.
748. In its Defence¹⁶⁸, ACER responds that the prioritisation of LFs above the threshold (i) does not violate the principle of non-discrimination under Articles 16(1) ER and Articles 3(e) and 74(6)(i) CACM (no equal treatment of LFs and IFs is provided under Articles 16(8) and (13) ER); (ii) does not violate Articles 74(6)(a), (b) and (f) and 3(g) CACM, does not violate the proportionality principle, and does not discriminate against larger BZs; (iii) does not violate Article 74(6)(b) CACM in conjunction with Article 76(1)(b)(v) SO; (iv) does not violate Article 74(6)(c) CACM; (v) does not violate the transparency principle; (vi) does not violate Articles 74(2) and (4)(b) CACM and does not violate the principle of conferral.
749. Intervener I intervenes on behalf of Appellant III.
750. Interveners II, III, IV, V and VI intervene on behalf of the Defendant.

¹⁶⁴ Appeal II, Plea 4, paras 85-106.

¹⁶⁵ Appeal III, Plea 3, paras 159-181.

¹⁶⁶ Appeal IV, Plea 4, paras 131-186.

¹⁶⁷ Appeal VI, Plea 4, paras 175-208.

¹⁶⁸ Defence, paras 593-616.

6.1 Characteristics of the priority stack.

751. Article 2(2)(a), (o), (p) and (s) of the Contested Decision's RDCTCS defines the following flows:

- “a) ‘allocated flow’ means a physical flow on a network element where the source and sink are located in different bidding zones;
- (o) ‘internal flow’ means a physical flow on a network element where the source and sink and the complete network element are located in the same bidding zone;
- (p) ‘loop flow’ means a physical flow on a network element where the source and sink are located in the same bidding zone and the network element or even part of the network element is located in a different bidding zone;
- (s) ‘PST flow’ means a physical flow on a network element, which is caused by a PST with a tap position not in neutral position. PST flow is a cyclic flow, with the sink and source located at the same network element (the PST)”.

752. Article 7(6) and (7) of the Contested Decision's RDCTCS determine that LFs beyond a legitimate level (i.e. the level that could be expected without structural congestion in a BZ) should be identified as the primary contributors to the congestion on internal NEs, whereas IFs should be penalised only for the remaining volume of congestion:

“(6) In order to identify which flow components contribute to congestion and to which degree, all Core TSOs shall calculate the volume of overload, which shall be equal to the total flow on the eligible XNEC before the RAO, reduced by the maximum flow on that XNEC. The contributions to the volume of overload shall be calculated as follows:

(a) The burdening loop flows from bidding zones within the Core CCR above the individual threshold calculated pursuant to paragraph 4 or 5 shall be identified as the first contributor to the volume of overload. If the volume of these burdening loop flows is higher than the volume of overload, the contribution of each burdening loop flow from bidding zone within the Core CCR above the individual threshold shall be reduced proportionally such that the sum of contributions from burdening loop flows from bidding zones within the Core CCR above the individual threshold is equal to the volume of overload. The burdening loop flow contributions to the volume of overload shall be attributed to bidding zones that are the origins of the respective burdening loop flow components.

(b) The burdening internal flow shall be considered as the second contributor to the volume of overload. The burdening internal flow contribution shall be equal to the volume of overload reduced by burdening loop flow contributions calculated pursuant to (a) and shall not be higher than the burdening internal flow.

(c) The rest of the contribution to the congestion shall be identified with the following flow components in the order of following priority:

- i. Burdening loop flow from outside the Core CCR;
- ii. Burdening loop flows from bidding zones within the Core CCR below the individual threshold;
- iii. Burdening allocated flow; and
- iv. Burdening PST flow.

(d) The contribution to the congestion pursuant to points (b) and (c) shall be attributed to the XNE connecting TSO. In case the concerned XNE of the XNEC is a network element connecting two Core bidding zones, and XNE connecting TSOs have defined the same F_{max} for this element, the corresponding costs for such XNEC pursuant to points (b) and (c) shall be shared 50:50 between the two XNE connecting TSOs. In case the XNE connecting TSOs Page 16 of 19 on both sides have defined a different F_{max} for the concerned XNE, the costs for such XNEC pursuant to point (b) and (c) shall be shared in accordance with the following formula:

$$S_{HI} = 0.5 \frac{\max(0, F_{total} - F_{max,HI})}{F_o}$$

$$S_{LO} = S_{HI} + \frac{\max(0, \min(F_{total}, F_{max,HI}) - F_{max,LO})}{F_o}$$

Equation 2

with

S_{LO}	Share of the costs for XNE connecting TSO which defined a lower F_{max} [%]
S_{HI}	Share of the costs for XNE connecting TSO which defined a higher F_{max} [%]
$F_{max,LO}$	Lower F_{max} [MW]
$F_{max,HI}$	Higher F_{max} [MW]
F_{total}	Total flow on XNEC [MW]
F_o	Volume of overload on XNEC which is equal to $F_{total} - F_{max,LO}$ [MW]

(7) The total costs attributed to XNEC as defined in Article 5(5) shall be split proportionally to the calculated contributions to congestion as defined in paragraph 6, where the burdening loop flow contributions are attributed to the concerned bidding zones and the remaining contributions to the XNE connecting TSO(s) pursuant to paragraph 6(d).”

753. Consequently, when deciding which flows cause a congestion on a NE, the flows are stacked on top of each other according to a prioritisation order, as follows:

- Burdening LFs from other BZs than the BZ where the XNEC is located within the Core CCR above the individual threshold
- Burdening IFs from the BZ where the XNEC is located
- Burdening LF from outside the Core CCR (within all bidding zones outside Core CCR)
- Burdening LFs from bidding zones within the Core CCR below the individual threshold
- Burdening AF from all cross-zonal exchanges within and outside the Core CCR
- Burdening PST flow from the effect of using all PSTs located within and outside the Core CCR

The flows exceeding 100% of the technical capacity of a NE are attributed to the TSO from whose transmission system the flows stem because they are considered as causing the congestion and are, hence, financially accountable in the RDCTCS. LFs above threshold are in the first position of the stack. This implies that LF polluting TSOs are the first ones to pay for RAs.

754. Paragraph 128 of the Contested Decision depicts the flow prioritisation that is used for the RDCTCS as follows:

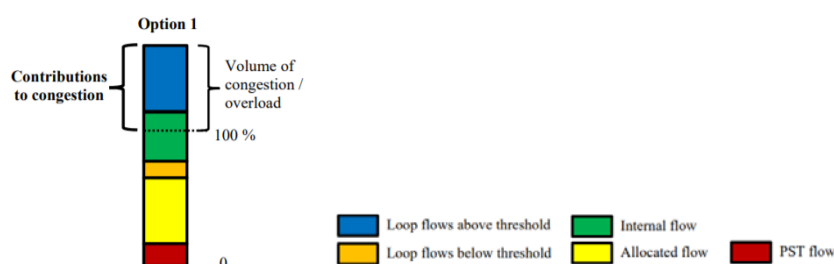

755. The Contested Decision’s RDCTCS prioritizes LFs over IFs in the stacking of the flow components. IFs may only be penalised for the remaining congestion after LFs above the threshold have been penalised.

6.2 The decision-making process leading-up to the Contested Decision.

756. As will be set out below in the Fourteenth Consolidated Plea, ACER adopted the Contested Decision on the basis of Article 6(10)(a) ACER Regulation and, to this end, it carried out the regulatory supervision of All Core TSOs’ RDCTCS Proposal under Article 74 CACM, which stipulates in Article 74(6)(f) that the RDCTCS needs to facilitate adherence to the general principles of CM as set out in Article 16 ER.

757. First, Article 7 of All Core TSOs’ RDCTCS Proposal recognised a principle of stacking flow components according to a priority list. It acknowledged that only the flow components sorted on the basis of the priority list exceeding the maximum flow on NEs should be identified as contributors to congestion. The Proposal did not, however, include a proposed priority list: *“Flow decomposition shall be performed on each congested XBRNE, either in base case or in a contingency case, and for each hour separately. In case the XBRNE list contains a network element with different contingencies causing overloads, the flow decomposition shall be performed on the contingency creating the overload which is the most difficult to relieve.”*

758. In the Explanatory Document accompanying All Core TSOs’ RDCTCS Proposal¹⁶⁹, All Core TSOs unanimously stated that the prioritisation principles depended on the decisions made on other topics: *“4.5.3 Prioritization. The final prioritisation principles depend on the decisions made on other topics. The aspects of prioritization which are taken into consideration are as following and not final:*

- *Loop flows above potential threshold are to be penalized first*
- *Coordinated market flows are to be penalized with low priority*
- *Penalization of the other flows (listed in the flow decomposition) is still to be determined*

¹⁶⁹ Annex 13 to the Defence.

Only flow types above the technical limit are penalized. This goes along with a strict ordering of the flow types, which includes the reasoning that there are “good” and “bad” flow types. The following sketch illustrates the idea:

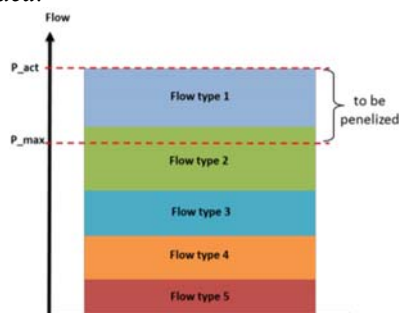

Figure 27: prioritization principle

The concrete ordering of the flows types should be based on a proper and agreed reasoning. This is a complex task and under discussion at the moment.”

In addition, All Core TSOs held in the same Explanatory Document that for the prioritisation of the different flows, burdening LFs were considered to be the most critical flows, which should be penalised in the first place to avoid free-riding of neighbouring countries: “For the prioritisation of the different flows identified by the flow decomposition methodology, burdening loop flows are seen as the most critical flows. In accordance with the ACER recommendation and to avoid free-riding of neighbouring countries, those flows should be penalised in the first place in case a XBRNE is overloaded. Therefore loop flows are considered as polluters. They are also, individually, associated with only one bidding zone. The electricity network of the Core CCR is highly meshed and in combination with the zonal design of the EU Internal Energy Market a certain level of loop flows is therefore inevitable, even with the most ambitious grid investments. Indeed, such a goal could lead to the target which could be opposite to the goals of internal electricity market (lower investments in cross-border lines). Due to these reasons a threshold for the loop flows could be considered. The consequence of applying a threshold is that a part of the loop flows gets accepted and gets less highly prioritised as the remaining bigger share.”

759. All Core NRAs evidenced divergent views as to whether IFs had to be considered as polluting flows or only LFs¹⁷⁰. A majority of Core NRAs held that “flows should be considered as polluter if and only if they result from transactions internal to bidding zones. In addition, would several categories of flows match this definition, the recast electricity regulation does not introduce any distinction between them. They shall be considered as equally polluting flows and put together at the top of the order stack. The costs induced by flows not resulting from transactions internal to a bidding zone should not be eligible to a sharing between TSOs. For the sake of clarity, TSOs may still need to identify separately loop flows and internal flows. Core NRAs acknowledge that such identification would be needed to correctly attribute each flow to the correct TSO⁴. However, after such identification, all flows resulting from transactions internal to bidding zones should be tackled equally.” Other Core NRAs considered “loop flows to be more polluting than internal flows”. These Core NRAs placed “loop flows at the top of the order stack”. One of these NRAs held that “the requirements set by Article 16(13) have to be combined with the requirement set by article 15(3) indicating that the costs linked to an action plan (and a decision of non-splitting a bidding zones – and here we refer to the costs related to loop-flows –) should be borne by the MS implementing an action plan. It can be expected that if internal flows and loop flows are considered equally polluting, a larger part of the costs related to solving structural internal congestion, will be transferred to other bidding zones. The extent of this distributional effect depends on the loop flow threshold (the larger the loop flow threshold, the more costs will be transferred to other bidding zones) and on the mapping. In the presence of action plans (and more generally in the presence of unsolved structural congestions – Article 15.1 and whereas 31) re-dispatching costs linked to internal congestions should not be transferred, not even partially, by the RAO process and consecutive cost sharing, to other TSOs owning transmission lines congested by the loop-flows generated by the same internal exchanges at the origin of the internal congestion.” Other NRAs did not share this view and objected that, just like LFs, IFs above a certain level could be the reflection of a structural congestion. For these NRAs, not penalizing such flows would result in transferring a part of a structural congestion and should be avoided.

760. In their Non-Paper (Section 1.9)¹⁷¹, All Core TSOs but Appellant I (advocating an IF threshold in relation to APs) agreed that the IF threshold should be set at 0% or should be

¹⁷⁰ Annex A.3.2 to Appeal VI.

¹⁷¹ Annex 79 to the Defence.

labelled as not-relevant for the cost sharing process. Neither Appellant III nor Appellant VI made a statement about the priority stack.

761. The Board of Appeal concludes that, in carrying out its functions of regulatory supervision, ACER had to take account of the fact that All Core TSOs' RDCTCS Proposal recognised the principle of a priority stack without setting a stack, whilst taking due account of the views of All Core NRAs. ACER had to ensure that All Core TSOs' RDCTCS Proposal complied with the applicable regulatory framework.

6.3 The validity of prioritising LFs above the threshold in the priority stack.

762. First of all, the Board of Appeal refers to the First Consolidated Plea, in which it has been set out that the RDCTCS scope is not restricted to interconnectors (XNEs located on a BZB) or tie-lines. Consequently, the RDCTCS applies to both LFs and IFs. All XNEs should be included, also internal XNEs (which host and cause a variety of flows, not only IFs).

763. Second, the Contested Decision correctly places burdening LFs from other Core BZs than the Core BZ where the XNEC is located above the threshold as no.1 in the priority list of the flow decomposition and correctly places burdening IFs from Core BZ where the XNEC is located as no.2 in the priority list of the flow decomposition.

764. LFs above the threshold come as no.1 in the priority list. If the congestion is larger than the sum of all burdening LFs or if the LFs are below the legitimate threshold, then BZs with IFs will bear the remaining costs, given that these IFs also contribute to the congestion. In other terms, IFs are penalised only for the remaining volume of congestion.

765. This prioritisation duly reflects the fact that LFs above the threshold are the primary contributors to the congestion on internal NEs. This is not a quantitative criterion, as advanced by some Appellants evidencing large volumes of IFs contributing to internal congestion, but a qualitative criterion. Appellants erroneously claim that LFs and IFs are equally polluting flows.

766. LFs are unpredictable and caused in another BZ than the BZ of the LF-causing TSO. As set out in the First Consolidated Plea, Sub-Plea 1.1.2, LFs are unavoidable in a zonal model and that is why Article 16(13) ER requires a LF threshold, allowing a portion of acceptable LFs below the threshold and penalising LFs above the threshold on the basis of the PPP.

767. IFs are predictable and caused in the BZ of the IF-causing TSO. There is no need for an IF threshold because IFs are not unavoidable in a zonal model and because they are, in any event, subject to the OPP. IFs are caused by the owner of the NE and, therefore, the polluter is also the owner. Applying the OPP or the PPP to IFs would place the cost burden on the same TSO.

768. Since IF-causing TSOs are financing the investment and maintenance of internal NEs via network fees or tariffs, whereas LF-causing TSOs are not, the LFs above the threshold (which is set at a level that could be expected without structural congestion in a BZ) should be identified as the primary contributor to the congestion. Indeed, network users trading within a BZ causing IFs pay network fees or tariffs to finance congested NEs inside their BZ, whereas network users trading with neighbouring BZs and causing LFs do not contribute to financing the congested NE outside their BZ.

769. All Core TSOs reached the same conclusion in the Explanatory Document accompanying All Core TSOs' RDCTCS Proposal¹⁷². They held that burdening LFs were the most critical flows for the prioritisation of flows and had to be penalised in the first place to avoid free-riding of neighbouring countries: *“For the prioritisation of the different flows identified by the flow decomposition methodology, **burdening loop flows are seen as the most critical flows**. In accordance with the ACER recommendation and **to avoid free-riding of neighbouring countries**, those flows should be **penalised in the first place** in case a XBRNE is overloaded. Therefore loop flows are considered as polluters. They are also, individually, associated with only one bidding zone. The electricity network of the Core CCR is highly meshed*

¹⁷² Annex 13 to the Defence.

and in combination with the zonal design of the EU Internal Energy Market a certain level of loop flows is therefore inevitable, even with the most ambitious grid investments. Indeed, such a goal could lead to the target which could be opposite to the goals of internal electricity market (lower investments in cross-border lines). Due to these reasons a threshold for the loop flows could be considered. The consequence of applying a threshold is that a part of the loop flows gets accepted and gets less highly prioritised as the remaining bigger share.” (emphasis added)

770. Placing IFs as no.1 in the priority list, alongside LFs above the threshold, would decrease the percentage of LFs above the threshold within the category of primary contributors to the congestion and remove them from the PPP. This observation was also made by Interveners II to VI.

771. It would also be unfair to treat IFs equally to LF above the threshold because the IFs have not been preliminarily filtered through an IF threshold. The LFs that are no.1 in the priority list are LFs that are above a level that could be expected without structural congestion, i.e. a first filter has been applied as to their contribution to the congestion. IFs have not been sorted by a similar first filter as to their contribution to the congestion. Merging filtered LFs above the threshold with unfiltered IFs would, consequently, be unfair.

772. That is the reason why, as set out in All Core NRAs’ Non-Paper and evidenced by the present appeals, the same stakeholders that opine that LFs above the threshold should not be prioritised above IFs in the order stack, also advocate an IF threshold. However, as set out above, an IF threshold would not only be based on a wrong rationale (because IFs do not share the same unpredictable nature as LFs) but would also have no other effect than diluting LF-causing TSOs’ responsibility under the PPP (because IFs are subject to the OPP).

773. Placing IFs as no.1 in the priority list, alongside LFs above the threshold, would also be discriminatory because LFs above the threshold and IFs are different, on the one hand, due to their distinct nature – which has been set out above – and, on the other hand, due to the fact that LFs in no.1 of the priority list have previously been filtered through the threshold, whereas IFs as no.2 of the priority list are unfiltered.

774. The different nature of LFs above the threshold and IFs is clearly set out in paragraphs 132 ad 133 of the Contested Decision:

“(132) On the other hand, ACER agrees with the majority of Core TSOs and regulatory authorities that loop flows and internal flows cannot be treated equally when identifying their contribution to congestion. This is because the network users which are causing internal flows on internal network elements are actually financing the investment and maintenance of such internal network element via network fees or tariffs. These are users trading within a Member State and are using the domestic network, whose construction and operation has been financed by these users. On the other hand, users causing loop flows on internal network elements have not financed the investment and maintenance of such internal network elements via network tariffs, because these are users trading within one Member State, but the loop flows they create are flowing through the network of another Member State, where they do not pay the network fees or tariffs.

(133) Furthermore, the electricity networks within Member States have been primarily dimensioned and built to accommodate internal trading within Member States and cross-zonal trading, but it has not been dimensioned to accommodate significant loop flows from internal trading in other Member States. Thus, in most cases, the internal network elements are sufficient to accommodate domestic internal trade and cross-zonal trade, but when significant loop flows from internal trading within other Member State are added on top, these elements become congested.” (emphasis added)

775. Placing only LFs as no.1 in the priority list is in accordance with Article 16(13) ER.

776. Article 16(13) ER reflects the PPP: it mandates regulatory authorities to identify the cause of the congestion and mandates TSOs, upon regulatory supervision, to determine a LF threshold in order to allocate costs to TSOs that are causing LFs above the threshold.

777. Article 16(13) ER reads as follows: “When allocating costs of remedial actions between transmission system operators, regulatory authorities shall analyse to what extent flows resulting from transactions internal to bidding zones contribute to the congestion between two bidding zones observed (...)” (emphasis added)

778. Article 16(13) ER orders regulatory authorities to analyse to what extent flows resulting from transactions internal to BZs contribute to the congestion between 2 BZs observed. Consequently, it orders regulatory authorities to identify polluting flows causing congestion, i.e. LFs and IFs. Article 16(13) ER does not, however, state anywhere that LFs and IFs need

to be treated equally. LFs can only be identified if they are distinguished from IFs. Article 16(13) ER requires that LFs be identified (and therefore distinguished from IFs) in order to allow TSOs, upon regulatory supervision, to determine a LF threshold aimed at penalising TSOs that are causing LFs above the threshold.

779. Article 16(13) ER does not mandate equality between polluting flows, i.e. it does not mandate equality between LFs and IFs. It neither contains nor prohibits a priority list. It merely mandates an identification of polluting flows and a LF threshold.
780. LF prioritisation is necessary to attain the objectives set by the CACM and the ER. As set out in Sub-Pleas 6.6 and 6.8, it creates the correct incentives to manage congestion and fosters the efficient development and operation of the EU interconnected system and electricity market in the long term (Article 74(6)(a) and (e) CACM). As set out in Sub-Plea 6.9, it is consistent with the responsibilities and liabilities of Core TSOs (Article 74(6)(b) CACM). As set out in Sub-Plea 6.10, it ensures a fair distribution of costs and benefits between Core TSOs (Article 74(6)(c) CACM). As set out in Sub-Plea 6.13, it facilitates adherence to the general principles of CM (Article 74(6)(f) CACM). Finally, as set out in the Twelfth Consolidated Plea, it complies with the principles of transparency and non-discrimination (Article 74(6)(i) CACM).
781. Placing IFs as no.1 in the priority list, alongside LFs above the threshold, is not in accordance with the PPP, contained in both Article 16(13) ER and Article 76(1) SO because it dilutes LFs above the threshold and treats unequal flows equal in violation of the principle of non-discrimination. It does not create the correct incentives to manage congestion and does not foster the efficient development and operation of the EU interconnected system and electricity market in the long term. It is not consistent with the responsibilities and liabilities of Core TSOs. It does not ensure a fair distribution of costs and benefits between Core TSOs.

6.4 The non-prioritised IFs are not caused by the LF polluting TSOs.

782. Appellant IV holds that the prioritisation of LFs above the threshold over IFs ignores the fact that LFs are inherent to a zonal model and refers to paragraph 109 of the Contested Decision to demonstrate that ACER acknowledges this.
783. The Board of Appeal refers to Sub-Plea 6.3, LFs that are no.1 in the priority list are LFs that are above a level that could be expected without structural congestion, i.e. a first filter has been applied as to their contribution to the congestion. The prioritisation of LFs above the threshold is corollary to the determination of a LF threshold that is precisely aimed at reflecting the fact that, in a zonal model, a certain level of LFs is acceptable. The prioritisation of LF refers to the part of LF above this threshold, hence, the part which is above the level which would exist without structural congestion.
784. Appellant IV opposes the fact that TSOs from whose BZ LFs originate have to bear a part of the costs induced by IFs that occur on the NEs of a TSO of another BZ because those IFs are, in its opinion, not caused by the LF polluting TSOs but by internal trading within the BZ where the congested NE is located.
785. Again, the Board of Appeal refers to Sub-Plea 6.3, which sets out why, even if LFs and IFs are present on a congested NE, LFs above the threshold are the primary contributors to the congestion. Reasoning otherwise erroneously reverses the PPP and applies it to the LF-hosting TSOs, which Article 16(13) ER does not identify as polluters that should contribute to the RDCTCS. In the absence of IFs or LFs from polluting flow causing TSOs, the internal NEs of the polluting flow hosting TSOs would not be congested. Article 16(13) ER does not define pollution as a lack of maintenance or investment. Pollution is clearly defined as the contribution to the congestion through electricity flows.
786. Appellant IV claims that, in a scenario of no-prioritisation of LFs above the threshold, both LFs and IFs would be equally penalised for congestions in proportion to their contribution to congestion. Appellant IV also alleges that the RDCTCS should not differentiate between LFs

and IFs because they are equally illegitimate because (i) they have the same physical effect on the NE, in that they cause or intensify the congestion in exactly the same way and (ii) they are caused by the fact that the network infrastructure of a control area of the design of a BZ is not developed in line with the demands for electricity trading.

787. The Board of Appeal refers to Sub-Plea 6.3. The fact that IF and LF have the same physical effect on a NE does not *per se* imply that they are equal and should be treated equally. As set out above, LFs are unpredictable, caused in another BZ than the BZ of the LF-causing TSO and their unavoidable nature in a zonal market model justifies a threshold for acceptable LFs. IFs are predictable, caused in the BZ of the IF-causing TSO and do not require a threshold because they are not unavoidable in a zonal model and because they are, in any event, subject to the OPP. In addition, IF-causing TSOs are financing the investment and maintenance of internal NEs via network fees or tariffs, whereas LF-causing TSOs are not. Therefore, LFs and IFs are different in nature and should not be penalised equally. Furthermore, the LFs stacked as no.1 are LFs that have been differentiated through the filter of a threshold in relation to their contribution to congestion, whereas the IFs are unfiltered. This reinforces the fact that LFs above the threshold and IFs should not be penalised equally.

6.5 ACER should have used Option 2 of paragraph 128 of the Contested Decision.

788. Appellant IV alleges that Option 2 of paragraph 128 of the Contested Decision identifies a smaller part of LFs and a larger part of IFs because, in its view, prioritising LFs leads to a quasi-automatic classification of all LFs as contributors to congestion. Appellant IV depicts a legally sound situation as follows:

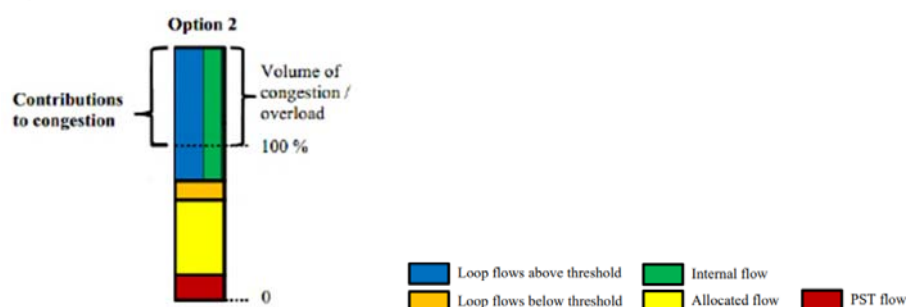

789. In its view, a legally sound priority listing of flow components requires a part of the LFs and a part of the IFs to be legitimate, because legally both LFs and IFs should be treated equally. Also, both illegitimate LFs and illegitimate IFs contribute to congestion. It refers to paragraph 133 of the Contested Decision to support its view. Appellant IV holds that LFs and IFs contribute equally to congestion because they behave equally under the laws of physics. According to Appellant IV, paragraph 132 of the Contested Decision justifies a differentiation between undesired, illegitimate LFs and legitimate IFs (generated by a desired NE use), but not between LFs and IFs.

790. The Board of Appeal refers to Sub-Plea 6.3. Given that LFs and IFs are different in nature and given that LFs stacked as no.1 are LFs that have been filtered through a threshold in relation to their contribution to congestion, whereas the IFs are unfiltered, they should not be penalised equally.

791. As set out above, paragraphs 132 and 133 of the Contested Decision highlight the differences between LFs and IFs in terms of the underlying financials and regarding the unavoidable nature of LFs in a zonal market model. It underlines the role of LFs above the threshold as primary contributor to the congestion. Appellant IV's statements reinforce the correct reasoning: because of the fact that there is a need to differentiate between legitimate LFs and illegitimate LFs and that there is no similar need as regards IFs generated by a desired NE use, LFs and IFs should not be treated equally.

792. The above-mentioned figure referred to by Appellant IV evidences that placing IFs as no.1 in the priority list, alongside LFs above the threshold decreases the percentage of LFs above the threshold within the category of primary contributors to the congestion and moves away from the PPP. This would provide Core TSOs with insufficient incentives to reduce LFs. It would, at the same time, provide unfair incentives to LF-hosting TSOs to invest, despite the true reason for congestion being outside of their responsibility. At the Oral Hearing, Appellant I correctly stated that the owners of internal lines congested by LFs have no influence on the level of LFs flowing through their grid and should not be forced to pay for the reinforcement of their grid, as this would make grid owners pay for investments that should be borne by the TSOs from BZs that caused the LFs.

6.6 Prioritisation of LFs above the threshold contradicts the EU internal market fostering renewable energies.

793. Appellant III claims that LF prioritisation contradicts the EU goal of an internal electricity market fostering the integration of renewable energies.

794. Appellant II claims that, in the long run, the absence of efficient incentives for TSOs could be detrimental to achieving the internal market, preventing high levels of capacity to transaction between BZs.

795. Appellant VI claims that the prioritisation of LFs above the threshold frustrates the goal of electricity market integration of Article 1(a), (b) and (d) ER.

796. Intervener I observes that LF prioritisation contravenes Article 74(6)(e) CACM.

797. Article 1(a), (b) and (d) ER state that the ER aims to “(a) set the basis for an efficient achievement of the objectives of the Energy Union and in particular the climate and energy framework for 2030 by enabling market signals to be delivered for increased efficiency, higher share of renewable energy sources, security of supply, flexibility, sustainability, decarbonisation and innovation; (b) set fundamental principles for well-functioning, integrated electricity markets, which allow all resource providers and electricity customers non-discriminatory market access, empower consumers, ensure competitiveness on the global market as well as demand response, energy storage and energy efficiency, and facilitate aggregation of distributed demand and supply, and enable market and sectoral integration and market-based remuneration of electricity generated from renewable sources; and (d) facilitate the emergence of a well-functioning and transparent wholesale market, contributing to a high level of security of electricity supply, and provide for mechanisms to harmonise the rules for cross-border exchanges in electricity.”

798. Article 74(6)(e) CACM requires the RDCTCS “to facilitate the efficient long-term development and operation of the pan-European interconnected system and the efficient operation of the pan-European electricity market.”

799. The Board of Appeal notes that Appellant VI omits to invoke compliance with Article 1(c) ER in paragraph 185 of its appeal, which sets out the aim of the ER to “(c) set fair rules for cross-border exchanges in electricity, thus enhancing competition within the internal market for electricity, taking into account the particular characteristics of national and regional markets, including the establishment of a compensation mechanism for cross-border flows of electricity, the setting of harmonised principles on cross-border transmission charges and the allocation of available capacities of interconnections between national transmission systems”.

800. This omission is not insignificant.

801. As set out above, placing IFs as no.1 in the priority list, alongside LFs above the threshold, would not set fair rules for CB exchanges in electricity because (i) it decreases the percentage of LFs above the threshold within the category of primary contributors to the congestion, moving away from the PPP and (ii) it is discriminatory due to the different nature of LFs and IFs and the fact that LFs as no.1 of the priority list have previously been filtered through a threshold. This would not provide correct incentives to Core TSOs to manage congestion efficiently (including RAs) and to invest. TSOs of LF-causing BZs would be less incentivised to reduce LFs by means of BZ reconfiguration or network investments. Rather, placing IFs as no.1 in the priority list, alongside LFs above the threshold, would provide wrong incentives as TSOs creating LFs above the threshold need to be held accountable and reduce them. As correctly worded in paragraph 134 of the Contested Decision, it would provide Core TSOs

with insufficient incentives to reduce LFs. It would, at the same time, provide unfair incentives to LF-hosting TSOs to invest, despite the true reason for congestion being outside of their responsibility.

802. Placing IFs as no.2 of the priority list correctly provides incentives to LF-causing TSOs to manage their congestion problems and reduce LFs below the threshold. It also gives LF-hosting TSOs correct incentives to reduce IFs only in case the LFs are below the threshold. If there is still congestion on an internal NE when LFs are below the threshold, IFs are the reason for the congestion and should be penalised.
803. Moreover, introducing a corollary IF threshold would not only be based on a wrong rationale (because IFs do not share the same unpredictable nature as LFs) but would also have no other effect than diluting LF-causing TSOs' responsibility under the PPP (because IFs are subject to the OPP).
804. In the long run, these incorrect incentives would undermine the attainment of an internal electricity market. They would hinder an efficient achievement of the objectives of the EU, a well-functioning, integrated electricity market and the emergence of a well-functioning and transparent wholesale market, contributing to a high level of security of electricity supply, and providing for mechanisms to harmonise the rules for CB exchanges in electricity, as per Article 1 ER.
805. Regarding Appellant III's claim that LF prioritisation contradicts the promotion of RES, the Board of Appeal notes that climate change measures require investments that can only adequately be carried out in a Core region that is coordinated in terms of RAs. A correct identification of LFs above the threshold as primary contributors to the congestion is key to a cost sharing methodology that effectively coordinates RAs and provide Core TSOs with the correct incentives in terms of investments. These correct investment initiatives by All Core TSOs allow for a smooth transition of the entire Core CCR towards decarbonisation.
806. Appellant II claims that ACER acknowledged in email correspondence to NRAs, members of the BoR, that part of the IFs had to be treated in the first priority, on the basis of the underlying rationale that *"This proposal aims to provide a good balance between two conflicting objectives, i.e. i. to manage congestions efficiently and thereby reduce loop flows ii. to invest in internal network and thereby reduce congestions loop flows ii. to invest in internal network and thereby reduce congestions"*.¹⁷³
807. The Board of Appeal highlights that the decision-making process leading-up to the Contested Decision is a bottom-up decision-making process, whereby all stakeholders involved exchange opinions and provide input to attain an optimal solution that ensures compliance with the applicable regulatory framework. This is in accordance with the Board of Appeal's earlier case-law¹⁷⁴.

6.7 Prioritisation of LFs above the threshold infringes Article 16(13) ER and the PPP.

808. Appellant III alleges an infringement of the PPP because, if some BZs have permanent internal congestions in their grid or shift their internal congestions to the borders leading to internal NEs being close to the limit of their technical availability (close to 100%) and if LFs occur on said NEs, this might lead to an overload (over 100%) and the costs for RAs to remedy the internal congestion would be borne by the TSOs that caused the LFs. In its view, the PPP is infringed because the cause is the internal congestion, not the LF.
809. Appellant III claims that if LFs occur on internal NEs being close to the limit of their technical availability this may result in an overload of these internal NEs and the costs for RA have to be borne by the TSO where the LP originate. It further alleges that it is possible that

¹⁷³ Annex IV to Appeal II.

¹⁷⁴ Board of Appeal Decisions A-004-2019, para 233; A-001-2020, paras 14, 102, 106, 138, 139, 160, 161, 184, 188, 234 and 258; A-002-2020, paras 14, 102, 106, 139, 140, 161, 162, 185, 189, 235 and 259; A-003-2020, para 14; A-007-2020, paras 5, 14, 68, 103 and 104; and A-008-2020, paras 19, 113-115, 138, 150, 153, 165, 167, 175, 188, 218, 239, 250, 290, 297 and 326.

TSOs intentionally use topology measures to push internal flows on NEs that are anyway congested, given that LFs are automatically prioritised and that the LF polluting TSOs will hence bear the costs of a possible overload of this NE. In its Reply¹⁷⁵, Appellant III reiterates that pushing internal congestions to the borders is one big obstacle on the way to a European internal electricity market.

810. The Board of Appeal refers to Sub-Plea 6.3 above, which sets out that placing IFs as no.2 of the priority list is in accordance with Article 16(13) ER and the PPP. As to the possibility for TSOs to intentionally use topology measures to push IFs on NEs that are anyway congested in order to make LFs pay for the costs of RAs necessary to relieve the physical congestion on these NEs - since they are the primary contributors -, the argument is flawed. First, TSOs cannot really push IFs because IFs come from activities of market participants and are beyond any TSO control and because IFs can only be mitigated by applying RAs which are subject to cost sharing. Second, even if it were possible, this intentional push is unlikely to occur given the monitoring obligations of Core TSOs as per Article 10(2) of the Contested Decision's RDCTCS, which provides that, in case one or more Core TSOs identify or suspect abusive behaviour (such as systematic forecast errors) or other negative impact of such forecasting, all Core TSOs shall further investigate whether the concerned TSO has gained any financial advantage from such behaviour. Third, incentives for such intentional pushes are relatively low. Indeed, if the congestion is larger than the sum of the burdening LFs due to this intentional push, IFs will contribute to the cost sharing. Furthermore, the calculation as to whether the congestion will be high enough to increase the share to be paid by LFs but not high enough to increase the share to be paid by IFs is extremely difficult to make given the unpredictable nature of LFs.

811. In Annex 100 to its Rejoinder, ACER includes two numerical examples to illustrate that the alleged intentional push is a flawed argument.

812. The Board of Appeal summarizes one of the examples below for the sake of completeness.

813. The example shows that there is clearly no rational reason or incentive for TSOs to intentionally push their IFs level because, by doing so, they only unnecessarily increase the total load on the NE, worsening the congestion, and eventually bear the costs of the remaining volume of overload.

Example 1 of Annex 100 to ACER's Rejoinder:

Due to a push of IFs, the congestion is larger than the sum of the LFs above the threshold, prioritised as no.1. As IFs are no. 2 of the priority list, the TSOs who pushed IFs will in fact end-up paying for the remaining volume of congestion because their IFs also contribute to the congestion.

Scenario 1 illustrates a NE without an intentional push of IFs:

Scenario 1

Types of flows	MW
Market flows	500
Internal flows (TSO A)	600
Loop flows (TSO B)	150
Loop flows (TSO C)	-200
Total loading	1050

Fmax	1000
Overload	50
10% of Fmax	100
LFs > 10% thr	50
Remaining overload	0

- Fmax of NEs = 1000 MW
- total loading = 1050 MW (500 + 600 + 150 – 200 MW)
- overload = 50 MW (1050 – 1000 MW)
- 10% LF threshold => 100 MW (10% x 1000 MW) are legitimate LFs
- TSO A generates 600 MW burdening IFs.
- TSO C generates -200 MW relieving LFs, i.e. does not contribute to the congestion, i.e. bears 0 cost.
- TSO B generates 150 MW burdening LFs: 100 MW legitimate LFs + 50 MW illegitimate LFs stacked as no.1.

The remaining overload after subtracting burdening LFs is 0 (50 MW – 50 MW).

¹⁷⁵ Reply of Appellant III, para 60.

Hence, TSO B bears the entirety of the costs of the RA used to relieve congestion because IFs are stacked as no.2 and there is no remaining overload after no.1. TSO A bears 0 costs.

Scenario 2 illustrates a situation with an intentional push of IFs:

Scenario 2

Types of flows	MW
Market flows	500
Internal flows (TSO A)	700
Loop flows (TSO B)	150
Loop flows (TSO C)	-200
Total loading	1150

Fmax	1000
Overload	150
10% of Fmax	100
LFs > 10% thr	50
Remaining overload	100

- Fmax of NEs = 1000 MW
- total loading = 1150 MW (500 + 700 + 150 – 200 MW)
- overload = 150 MW (1150 – 1000 MW)
- 10% LF threshold => 100 MW (10% x 1000 MW) are legitimate LFs
- TSO A generates 700 MW burdening IFs.
- TSO C generates -200 MW relieving LFs, i.e. does not contribute to the congestion, i.e. bears 0 cost.
- TSO B generates 150 MW burdening LFs: 100 MW legitimate LFs + 50 MW illegitimate LFs stacked as no.1.

TSO A intentionally pushes its IF volume on the NE.

The remaining overload after subtracting burdening LFs is 100 MW (150 MW – 50 MW).

Hence, as IFs are stacked as no.2, and there is 100 MW remaining overload after no.1, TSO A bears 100 MW costs.

814. Appellant III also alleges that, under a correct application of the PPP, the TSO from whose network LFs stem are not polluters because LFs are the result of the physics of electricity and caused by the transactions of market participants (facilitated over networks) or integration of renewable energies.

815. The Board of Appeal refers to Sub-Pleas 6.3 and 6.4 above. The fact that IF and LF have the same physical effect on a NE does not *per se* imply that they are equal and should be treated equally. Appellant III erroneously reverses the PPP and applies it to the polluting flow hosting TSOs, which Article 16(13) ER does not identify as polluters that should contribute to the RDCTCS. In the absence of IFs or LFs from polluting flow causing TSOs, the internal NEs of the polluting flow hosting TSOs would not be congested. Article 16(13) ER does not define pollution as a lack of maintenance or investment. Pollution is clearly defined as the contribution to the congestion through electricity flows.

816. Appellant IV claims that prioritising LFs infringes Article 74(6)(b) CACM in conjunction with Article 16(13) ER. This is because regulatory authorities are required to apply a certain verification standard when allocating costs of RAs between TSOs, whose responsibilities are codified in accordance with the PPP in Article 16(13) ER. ACER had to analyse to what extent flows resulting from internal transactions contribute to the congestion between 2 BZs observed and allocate the costs based on the contribution to the congestion to the TSOs of the BZs creating such flows.

817. As set out above in Sub-Pleas 6.3 and 6.6, placing IFs as no. 2 of the priority list provides correct incentives to Core TSOs in order to comply with their responsibilities and liabilities in accordance with Article 74(6)(b) CACM and duly take measures to reduce LFs below the threshold through various measures, e.g. network investments.

818. Appellant IV alleges that Article 16(13) ER requires ACER to recognise that all IFs and LFs have to be treated as equally contributing to the congestion. It quotes paragraph 130 of the Contested Decision, where ACER correctly states that IFs and LFs “*should (...) be identified as the main contributors to the congestion and the TSOs of bidding zones in which those exchanges are settled should therefore bear the proportional part of the costs attributed to the congested network element*” and that “*in case of internal network elements, these flows are the internal flow (...) being caused by electricity exchanges within a bidding zone where such network element is located (...)*.” Appellant II equally claims that Article 16(13) ER does not differentiate between LFs and IFs. The Contested Decision states in paragraph (131): “*ACER recognises that Article 16(13) of the Electricity Regulation does not make a specific distinction*

between loop flows and internal flows when referring to flows resulting from electricity exchanges (i.e. transactions) internal to bidding zones. However, this Article requires regulatory authorities to analyse to what extent loop flows and internal flows contribute to congestion, but it does not prescribe the extent to which they contribute to congestion. Article 16(13) of the Electricity Regulation therefore provides regulatory authorities the freedom to analyse and conclude to what extent the loop flows and internal flows contribute to congestion. ACER considers that a conclusion by regulatory authorities that loop flows contribute to congestion more than internal flows is therefore not contradicting Article 16(13) of the Electricity Regulation.” (emphasis added)

819. In Appellant IV’s¹⁷⁶ view, the wording “analysing to what extent” in Article 16(13) ER requires ACER to split the costs proportionally to the calculated contributions to congestion according to the PPP. It adduces that the input for the proportional splitting of Article 7(7) and (8) RDCTCS, provided by Article 7(6) RDCTCS, infringes the PPP because it burdens the LF polluter with additional costs beyond his area of responsibility. Appellant II claims that ACER’s interpretation is inconsistent with the ER, which treats LFs and IFs equally.
820. The Board of Appeal refers to Sub-Plea 6.3 above, which sets out why LFs and IFs should be differentiated and why prioritising LFs above the threshold is not only in accordance with Article 16(13) ER but also required to ensure full compliance with Article 16(13) ER.
821. Appellant IV claims that LF prioritisation infringes the requirement to facilitate adherence to the LF contribution verification standard and the PPP. This is because Article 74(6)(f) CACM requires the RDCTCS to facilitate adherence to the general principles of CM of Article 16 ER and LF prioritisation infringes the PPP codified *inter alia* in Article 16(13) ER and the principle of non-discrimination of Article 16(1) ER.
822. Again, the Board of Appeal refers to Sub-Plea 6.3. Given that the prioritisation of LFs above the threshold is required in order to ensure compliance with Article 16(13) ER, it neither infringes the PPP nor the requirement of Article 74(6)(f) CACM that the RDCTCS should facilitate adherence to the general CM principles of Article 16 ER. As set out above in Sub-Plea 6.3, placing IFs as no.1 in the priority list, alongside LFs above the threshold, would infringe Article 16(1) ER. Indeed, it would be discriminatory because LFs above the threshold and IFs are different, on the one hand, due to their distinct nature and, on the other hand, due to the fact that LFs as no.1 of the priority list have previously been filtered through the threshold, whereas IFs as no.2 of the priority list are unfiltered. Placing IFs as no. 2 of the priority list also provides correct incentives to Core TSOs in order to comply with their responsibilities and liabilities in accordance with Article 74(6)(b) CACM and duly take measures to reduce LFs below the threshold through various measures, e.g. network investments.

6.8 Prioritisation of LFs above the threshold infringes Article 74(6)(a) CACM.

823. Article 74(6)(a) CACM states that the RDCTCS shall provide incentives to invest effectively.
824. Appellants II, III and IV claim that prioritisation of LFs above the threshold provides wrong incentives. Appellant III states that it incentivizes a network expansion policy that remains focused on national interests because it allocates costs for RAs on internal NEs primarily to the TSOs in whose network LFs originate and not to the TSOs in whose network the internal congestion resides. Appellant IV claims that it does not incentivize TSOs hosting internal NE congestions to invest in their network and even provides false incentives not to invest.
825. Appellant III claims that these wrong incentives impede a removal of internal congestions through incentives for network investments, contrary to Article 3(h) ER, which contains, as a general principle of the operation of electricity markets, a progressive removal of “barriers to cross-border electricity flows between bidding zones in Member States and cross-border transactions on electricity markets and related services markets”.
826. Appellant II claims that this is contrary to Article 3(g) ER, which states, as a general principle of the operation of electricity markets, that market rules “shall deliver appropriate investment

¹⁷⁶ Appellant IV appeal para 146.

incentives for generation, in particular for long-term investments in a decarbonised and sustainable electricity system, energy storage, energy efficiency and demand response to meet market needs, and shall facilitate fair competition thus ensuring security of supply”.

827. Appellant IV claims that LF polluting TSOs are not given correct incentives because (i) they are not competent to invest in network infrastructure of the TSOs hosting the congested internal NEs, and (ii) investments in their own network infrastructure is not capable of alleviating the internal congestion on the network of the TSOs hosting the congested internal NEs.
828. Intervener I observes that the originators of LFs have no influence on the expansion of the NE that is facing congestion. In its view, due to the prioritisation of LFs over IFs, the TSO in whose control area the congested internal line is located has no incentive to invest in its grid or to optimise the management of its congestions.
829. The Board of Appeal refers to Sub-Plea 6.6 above, which sets out that placing IFs as no.2 of the priority list creates correct incentives, whereas placing IFs as no.1 of the priority list, alongside LFs above the threshold, does not create correct incentives and, what is more, creates wrong incentives.
830. Moreover, placing IFs as no.1 of the priority stock would go hand-in-hand with an IF threshold based on a wrong rationale (because IFs do not share the same unpredictable nature as LFs) but would also have no other effect than diluting LF-causing TSOs’ responsibility under the PPP (because IFs are subject to the OPP).
831. The correct prioritisation of LFs above the threshold is in accordance with the objectives of the CACM of Article 3 ER given that it provides appropriate investment incentives to Core TSOs, *“in particular for long-term investments in a decarbonised and sustainable electricity system, energy storage, energy efficiency and demand response to meet market needs, and shall facilitate fair competition thus ensuring security of supply”* and contributes to the progressive removal of barriers to CB electricity flows between BZs in Member States and fosters CB transactions on the electricity market.
832. At the Oral Hearing, Appellant II acknowledged that ACER’s incentives on LF prioritisation would be right and would deliver good results in terms of incentives to build transmission systems and operate them efficiently in a theoretical world in which national networks are sufficiently dimensioned in order to encompass all IFs but that this is not the case, especially in the Core region. In Appellant II’s opinion, LFs are frustrated, unrealised IFs. If the national network would have been sufficiently dimensioned, these LFs would have realised themselves as IFs.
833. The Board of Appeal notes that Appellant II’s statement at the Oral Hearing does not only recognise but reinforces the relevance of correct investment incentives in order to remedy the underlying network problems that cause congestion.

6.9 Prioritisation of LFs above the threshold infringes Article 74(6)(b) CACM.

834. Appellants II and III claim that prioritisation of LFs above the threshold is inconsistent with the responsibilities of the TSOs in whose networks the internal NEs are congested. In its view, those TSOs are responsible to invest in their internal network to avoid internal congestion.
835. Article 74(6)(b) CACM states that the RDCTCS shall be consistent with the responsibilities and liabilities of the TSOs involved.
836. As set out above in Sub-Pleas 6.3 and 6.6, placing IFs as no. 2 of the priority list provides correct incentives to Core TSOs in order to comply with their responsibilities and liabilities in accordance with Article 74(6)(b) CACM and duly take measures to reduce LFs below the threshold through various measures, e.g. network investments.

6.10 Prioritisation of LFs above the threshold infringes Article 74(6)(c) CACM.

837. Appellant IV claims that the prioritisation of LFs above the threshold is unfair because it over-penalises LF polluting TSOs in general and LF polluting TSOs from large BZs in

particular, e.g. France, German and Luxembourg TSOs. It refers to paragraph 115 of the Contested Decision, where ACER acknowledges that “TSOs from larger zones create larger loop flows”. Appellant IV refers to an analogy with the free movement of workers within the EU but does not develop the analogy.

838. Intervener I observes that the way in which different flow types are prioritised and penalised has a direct influence on the costs and benefits assigned to the BZs and that an unequal treatment of LFs and IFs on non-CB lines contributes directly to an unfair treatment of BZs and an unfair cost sharing.
839. Article 74(6)(c) CACM states that the RDCTCS shall ensure a fair distribution of costs and benefits between the TSOs involved.
840. The Board of Appeal refers to Sub-Plea 6.3 above, which sets out that the LFs above the threshold are the primary contributors to the congestion and that their prioritisation as no.1 in the priority list does not amount to an over-penalisation of LFs.
841. The Board of Appeal refers to the Twelfth Consolidated Plea regarding Appellant IV’s claim that the priority list of the Contested Decision’s RDCTCS discriminates against larger BZs.

6.11 Prioritisation of LFs above the threshold lacks consistency with LF contribution and PPP under SO.

842. Appellant IV claims that the prioritisation of LFs above the threshold impedes TSOs to comply with the PPP laid down in Article 76(1)(b)(v) SO. That is because Article 74(6)(b) CACM states that the RDCTCS shall be consistent with the responsibilities and liabilities of the TSOs involved, which imply, *inter alia*, the responsibilities of TSOs laid down in Article 76(1)(b)(v) SO. Article 76(1)(b)(v) SO states that the ROSC shall determine “the sharing of the costs of remedial actions referred to in Article 22, complementing where necessary the common methodology developed in accordance with Article 74 of Regulation (EU) 2015/1222”, followed by the SO PPP: “As a general principle, costs of non-cross-border relevant congestions shall be borne by the TSO responsible for the given control area and costs of relieving cross-border-relevant congestions shall be covered by TSOs responsible for the control areas in proportion to the aggravating impact of energy exchange between given control areas on the congested grid element.”. In Appellant IV’s view, given that it has not been necessary to complement the ROSC with the RDCTCS in accordance with Article 74 CACM, TSOs must comply with the rest of Article 76(1)(b)(v) SO, namely the SO PPP, which stresses that costs must be shared proportionally between LF polluting TSOs.
843. The PPP of Article 76 SO states: “1. Costs of non-cross-border relevant congestions shall be borne by the TSO responsible for the given control area and costs of relieving cross-border-relevant congestions shall be covered by TSOs responsible for the control areas in proportion to the aggravating impact of energy exchange between given control areas on the congested grid element. 2. In determining whether congestion have cross-border relevance, the TSOs shall take into account the congestion that would appear in the absence of energy exchanges between control areas”.
844. Article 76(1) SO states that costs of non-CB relevant congestions shall be borne by the TSO responsible for the given control area.
845. LF prioritisation complies with this: LF prioritisation is part of the Contested Decision’s RDCTCS, which does not apply to non-XNEs.
846. Article 76(1) SO further states that costs of relieving CB-relevant congestions shall be covered by TSOs responsible for the control areas in proportion to the aggravating impact of energy exchange between given control areas on the congested grid element. In other terms, costs of XRAs shall be covered by responsible TSOs in proportion to their contribution to the congestion on the congested XNE. The provision correctly reflects that, according to the PPP, TSOs need to contribute to the costs of XRAs “in accordance to their contributing to the congestion”.
847. Similarly to Article 16(13) ER, Article 76(1) ER requires that the congestion on XNECs be identified in order to make congestion-causing TSOs contribute to RA costs on those XNECs. Similarly to Article 16(13) ER, Article 76(1) SO does not, however, state anywhere that LFs and IFs need to be treated equally. Article 16(13) ER does not mandate equality between

polluting flows, i.e. it does not mandate equality between LFs and IFs. It neither contains nor prohibits a priority list. It merely mandates an identification of polluting flows and a LF threshold.

848. Placing only LFs as no.1 in the priority list is in accordance with the PPP, contained in both Article 16(13) ER and Article 76(1) SO. LF prioritisation is also necessary to attain the objectives set by the CACM and the ER. As set out in Sub-Pleas 6.6 and 6.8, it creates the correct incentives to manage congestion and fosters the efficient development and operation of the EU interconnected system and electricity market in the long term (Article 74(6)(a) and (e) CACM). As set out in Sub-Plea 6.9, it is consistent with the responsibilities and liabilities of Core TSOs (Article 74(6)(b) CACM). As set out in Sub-Plea 6.10, it ensures a fair distribution of costs and benefits between Core TSOs (Article 74(6)(c) CACM). As set out in Sub-Plea 6.13, it facilitates adherence to the general principles of CM (Article 74(6)(f) CACM). Finally, as set out in the Twelfth Consolidated Plea, it complies with the principles of transparency and non-discrimination (Article 74(6)(i) CACM).
849. Placing IFs as no.1 in the priority list, alongside LFs above the threshold, is not in accordance with the PPP, contained in both Article 16(13) ER and Article 76(1) SO because it dilutes LFs above the threshold and treats unequal flows equal in violation of the principle of non-discrimination.

6.12 Prioritisation of LFs above the threshold is incoherent with Article 16(8)ER.

850. Appellants II and IV claim that the prioritisation of LFs above the threshold is inconsistent with Article 16(8) ER. That is because Article 74(6)(b) CACM states that the RDCTCS shall be consistent with the responsibilities and liabilities of the TSOs involved, which imply, *inter alia*, the responsibility to use 30% of their capacity for RAM, LFs and IFs alike. In their view, Article 16(8) ER does not prioritize LFs over IFs.
851. Appellant II refers in this context to Recital 27 ER, which states that “*Clear minimum levels of available capacity for cross-zonal trade need to be put in place in order to reduce the effects of loop flows and internal congestions on cross-zonal trade and to give a predictable capacity value for market participants.*”. The ER recognises in Appellant II’s opinion that both LFs and IFs are polluting.
852. Appellant VI also claims that prioritisation of LFs above the threshold is a breach of the capacity maximisation principle.
853. As set out above in Sub-Pleas 6.3 and 6.6, placing IFs as no. 2 of the priority list provides correct incentives to Core TSOs in order to comply with their responsibilities and liabilities in accordance with Article 74(6)(b) CACM and duly take measures to reduce LFs below the threshold through various measures, e.g. network investments.
854. Article 16(8) ER does not mandate equality between polluting flows, i.e. it does not mandate equality between LFs and IFs because it does not relate to cost sharing. The Board of Appeal also refers to the First Consolidated Plea, Sub-Pleas 1.1.2, 1.3 and 1.7, with respect to the relationship between the CC process and the RDCTCS.
855. First, the RDCTCS relates to RDCTs, which are CM measures, whereas Article 16 ER contains the “*general principles of capacity allocation and congestion management*”, i.e. it covers a wider scope of CACM, i.e. CM and CA. Regardless of the fact that the ER has been adopted after the CACM, the Contested Decision’s RDCTCS needs to comply with the ER to the extent that they are CM principles, because RDCT are CM measures and not CA measures. Yet the general principles of Article 16 ER contain both CA and CM measures.
856. Second, LF prioritisation complies with the general principles of CM contained in Article 16 ER, especially Articles 16(1) and 16(13) ER. As is set out in Fourteenth Consolidated Plea, ACER was under a regulatory obligation to prioritise LFs above the threshold in order to ensure compliance with Article 16(13) ER and with its overall mandate to adopt the RDCTCS decision in accordance with the CACM. As set out in the Twelfth Consolidated Plea, LF prioritisation does not violate the principle of non-discrimination.

857. Third, Article 16(8) ER contains a general principle of CA (maximising interconnection capacity or CZC up to 70% and maintaining 30% for IFs, LFs and the reliability margin). This principle applies to the CC processes but not to the cost sharing process of the RDCTCS. Both processes are different CACM measures serving different goals at different points in time, as set out in the First Consolidated Plea. CC processes do not execute costly RAs and, therefore, no costs arise from them.
858. Fourth, the 30% reserved for IFs, LFs and reliability margin is not a threshold but a cap. Article 16(8) ER codified the cap that had been set by ACER in ACER Decision 02/2019 (Article 10(5) of the DA CCM and Article 10(5) of the ID CCM). In ACER Decision 02/2019, ACER decided to cap IFs, LFs and reliability margin to a maximum of 30% of allowable flows on CNECs. This consequently required that at least 70% of maximal allowable flows on CNECs be reserved for CZ exchanges¹⁷⁷. The 70% is a *de minimis* requirement and TSOs have the obligation to maximise trade beyond 70% if they can, without applying costly RAs¹⁷⁸. ACER reached the conservative figure of 70% through a benchmarking exercise on limited data made available by the CWE and Nordic TSOs, which did not take account of XRA-related cost sharing process. Given its nature of a cap, the 30%-reserve for IFs, LFs and reliability margin is, as Appellants correctly indicate, floating: if CZ exchanges take-up 85%, there will only be 15% left for IFs, LFs and reliability margin. The LF-threshold in cost sharing is, due to the fact that it is a threshold, not flexible: LFs above the threshold are not considered legitimate whereas LFs below the threshold are considered legitimate. The wording of Article 16(13) ER is clear in that it requires a threshold and not a cap.
859. Fifth, the 30%-cap for IFs, LFs and reliability margin is not affected by the prioritisation of LFs.
860. Recital 27 ER, requiring “*clear minimum levels of available capacity for cross-zonal trade*” does not relate to any cost sharing but to the CC process.

6.13 Prioritisation of LFs above the threshold infringes the requirement to facilitate adherence to the LF contribution verification standard and the PPP.

861. Appellant IV claims that the prioritisation of LFs above the threshold infringes Article 74(6)(f) CACM - which requires the RDCTCS to facilitate adherence to the general principles of CM of Article 16 ER - read in conjunction with the PPP as codified *inter alia* in Article 16(13) and (1) ER.
862. The Board of Appeal notes that LF prioritisation duly facilitates adherence to the general CM principles of Article 16 ER. As set out in Sub-Plea 6.3 above, Article 16(13) ER requires that LFs above the threshold be penalised because they are the primary contributors to the congestion. Placing IFs as no.2 of the priority list also avoids discrimination, as required by Article 16(1) ER (see Twelfth Consolidated Plea).

6.14 Prioritisation of LFs above the threshold infringes the requirement to give efficient economic signals addressing network congestions.

863. Appellant IV claims that the prioritisation of LFs above the threshold infringes Article 74(6)(f) CACM - which requires the RDCTCS to facilitate adherence to the general principles of CM of Article 16 ER - read in conjunction with Article 16(1) ER, which states that “*network congestion problems shall be addressed with non-discriminatory market-based solutions which give efficient economic signals to the market participants and transmission system operators involved*”.
864. Appellant VI similarly claims that the prioritisation of LFs above the threshold breaches the principle of efficiency without, however, clarifying what is meant by a breach of the principle of efficiency.

¹⁷⁷ ACER Decision 02/2019, para 124. Board of Appeal Decision A-001-2019, para 100.

¹⁷⁸ Board of Appeal Decision A-001-2019, para 115.

865. The Board of Appeal notes that LF prioritisation duly facilitates adherence to the general CM principles of Article 16 ER. With respect to the provision of efficient economic signals to the market participants and TSOs involved, placing IFs as no.1 in the priority list, alongside LFs above the threshold, would not set fair rules for CB exchanges in electricity because (i) it decreases the percentage of LFs above the threshold within the category of primary contributors to the congestion, moving away from the PPP and (ii) it is discriminatory due to the different nature of LFs and IFs and the fact that LFs as no.1 of the priority list have previously been filtered through a threshold.
866. This would not provide efficient economic signals to Core TSOs to manage congestion efficiently (including RAs) and to invest. The Board of Appeal refers to Sub-Plea 6.6 in this regard. Furthermore, placing IFs as no.1 of the priority list would not provide correct economic signals towards network users.
- IF-causing TSOs are financing the investment and maintenance of internal NEs via network fees or tariffs, whereas LF-causing TSOs are not, the LFs above the threshold (which is set at a level that could be expected without structural congestion in a BZ) should be identified as the primary contributor to the congestion. Indeed, network users trading within a BZ causing IFs pay network fees or tariffs to finance congested NEs inside their BZ, whereas network users trading with neighbouring BZs and causing LFs do not contribute to financing the congested NE outside their BZ.

6.15 Prioritisation of LFs above the threshold infringes the transparency principle.

867. Appellant IV claims that the prioritisation of LFs above the threshold infringes the transparency principle, embedded in Article 74(3) and (6)(i) CACM because it obliges TSOs to bear costs that stem from circumstances that are beyond their control and are not causally attributable to their conduct. It holds that transparency is a social context by which one is operating in an open way so that it is easy for others to see what actions are being performed and implies, *inter alia*, accountability. Prioritization of LFs does not hold TSOs hosting internal NE congestions accountable and erroneously holds TSOs creating LFs accountable.
868. Article 74(3) CACM states that “*redispatching and countertrading costs eligible for cost sharing between relevant TSOs shall be determined in a transparent and auditable manner*”.
869. Article 74(6)(i) CACM requires the RDCTCS “*to comply with the principles of transparency and non-discrimination*”.
870. The starting-point of Appellant IV’s claim is erroneous.
871. Appellant IV claims that LF-causing TSOs pollute outside of their BZ and that this cannot be attributable to them because it is outside of their BZ. It claims that this is “*beyond their control*”. It therefore claims that the costs deriving from LFs should be borne by the BZ in which the LF-causing TSO pollutes. In its Reply¹⁷⁹, Appellant IV held that the LF producer should not bear the costs induced by a lack of grid development in the internal network of the TSO affected by the LFs. This is because LFs polluters have, in its opinion, no conceivable influence, neither on those NEs nor on the subsequent costs.
872. The question arises as to which TSO is capable of “*controlling*” polluting LFs. Given that the answer is that the LF-causing TSOs can control polluting LFs whereas LFs are “*beyond the control*” of LF-hosting TSOs notwithstanding the fact that they occur in their BZs, Appellant IV’s starting-point is erroneous. LFs are not “*beyond the control*” of LF-causing TSOs because they are outside of their BZ (which is always the case in accordance with the definition of LFs).
873. The Board of Appeal finds that LF-causing TSOs should, on the contrary, be incentivised to take measures to reduce LFs. It would be unfair to provide LF-hosting TSOs with incentives to invest despite the fact that the causes of the congestion are outside of their responsibility.

¹⁷⁹ Reply of Appellant IV, para 8.

- 874.LF prioritisation is determined in a transparent and auditable manner. Article 7(6) and (7) of the Contested Decision's RDCTCS sets out the rule in a clear and unequivocal manner. Article 10 of the Contested Decision's RDCTCS contains a monitoring mechanism. Article 11 of the Contested Decision's RDCTCS requires All Core TSOs to duly report to Core NRAs and ACER and Article 12 of the Contested Decision's RDCTCS contains an annual review mechanism to identify possible improvements.
- 875.LF prioritisation in the Contested Decision's RDCTCS complies with the principle of transparency, which is linked to the principle of legal certainty, according to which *"rules imposing charges on the taxpayer must be clear and precise so that he may know without ambiguity what are his rights and obligations and may take steps accordingly"*¹⁸⁰. The Contested Decision's RDCTCS contains clear rules, which have been adopted following an in-depth bottom-up decision-making process including extensive consultations with the Appellants. Account should also be taken of the fact that the addressees of the Contested Decision are TSOs, which are sufficiently acquainted with the technicalities of the RDCTCS.

6.16 Evidence adduced by Appellants II and VI concerning the prioritisation of LFs above the threshold.

- 876.Appellant II provides evidence to illustrate that the design choice leads to allocating part or even all RDCT costs to LFs and allocating only a limited part or even no cost to IFs, whereas IFs sometimes contribute in volume to congestion to a much larger extent than LFs.
- 877.Appellant II also illustrates that the volume of IFs on overloaded internal NEs substantially differs across Core BZ and that this contradicts paragraph 133 of the Contested Decision, stating: *"Furthermore, the electricity networks within Member States have been primarily dimensioned and built to accommodate internal trading within Member States and cross-zonal trading, but it has not been dimensioned to accommodate significant loop flows from internal trading in other Member States. Thus, in most cases, the internal network elements are sufficient to accommodate domestic internal trade and crosszonal trade, but when significant loop flows from internal trading within other Member State are added on top, these elements become congested"*
- 878.Appellant II provides examples based on Confidential Data Treatment of Appellant VI.
- 879.Appellant II furthermore provides a theoretical example.
- 880.Appellant VI¹⁸¹ claims that ACER should not have used the outputs of Core TSOs' Experimentation Report¹⁸² for its analysis of the financial impacts of the threshold on TSOs because of its deficiencies. It refers to email correspondence by ACER of June 2020 referring to test results based on All Core TSOs' Experimentation Report¹⁸³. This, in its view, impeded a correct analysis of the balance between the expected financial impacts on TSOs responsible for LFs and their network users and customers, on the one hand, and the aims pursued by the Contested Decision, on the other hand, when assessing the prioritisation of LFs above the threshold.
- 881.The Board of Appeal finds that this claim is unfounded. First, given that the initiative comes from the market - and in more specifically from All Core TSOs - in the bottom-up RDCTCS decision-making process, ACER had to take account of All Core TSO's Experimentation Report, whilst duly acknowledging its disclaimers and caveats. Second, ACER did not rely upon All Core TSOs' Experimentation Report to carry out its assessment of the prioritisation of LFs above the threshold but carried out its own simulations. ACER's own simulations were based on All Core TSOs' Experimentation Report but included specific parameters aimed at addressing the concerns that All Core NRAs and All Core TSOs had conveyed to ACER during the consultation. When carrying out its own simulations, ACER simulated the results

¹⁸⁰ Case C-169/80, *Administration des douanes v Société anonyme Gondrand Frères and Société anonyme Garancini*, EU:C:1981:171, para. 17.

¹⁸¹ Appeal VI, Plea 7, paras 280-286.

¹⁸² Annex A.3.1 to Appeal VI.

¹⁸³ All Core TSOs' Experimentation Report, Annex 23 to the Defence, Annex A.2.7 to Appeal VI.

of other scenarios (by modifying the parameters of this same model) in order to (i) carefully evaluate the different arguments from Core TSOs and NRAs and (ii) investigate alternative options that were compliant with Articles 74 CACM and 16 ER.

882. This is clearly set out in paragraphs 94 to 104 of ACER’s Defence: ACER analysed All Core TSOs developed an Experimentation Report¹⁸⁴, which (i) analysed options based on 3 base scenarios (labelled green/yellow/blue, see [Table 1](#)); (ii) carried out a sensitivity analysis to test cost sharing results against different parameters in each of the scenarios, e.g. the PTDF threshold in relation to XNEs (see [Table 2](#)); and (iii) was limited to 10 timestamps i.e., 10 hours for which the costly and non-costly RAs are optimised within the Core region, which were taken from historical data and were deliberately chosen based on expert knowledge as well as agreed criteria (see [Table 3](#)).

Table 1: Scenarios of All Core TSOs’ Experimentation Report.

OPTIONS	GREEN	YELLOW	BLUE
Netting	Equal per category with credit	Equal per category with credit	proportional per category
Internal Flow threshold	Not applicable (no threshold for internal flows)		Y = 30%
Loop Flow threshold (5-10% already agreed in PT)	X = 10%	Common threshold of 20%	X = 0%
Cost allocation Market Flows	Owner of the line	Owner of the line	50:50 source-sink
Cost allocation for LF<x%	Owner of the line	Owner of the line	Causer pays
Order-stack	LF>x% (polluter) Internal flow (owner) LF<x% (owner) Market + PST (owner of the line)	LFs>th (polluter) and IFs (owner) LFs<th (owner) MFs and PST	LF> x% (polluter) IF> y% (owner) Market + PST (same level, polluter) LF < x% (polluter) IF < y% (owner)
Application LF threshold	Equal with credit	Equal with credit	Proportional split / Equal with credit (no NRs Agreement: 2 views)
Non-Core TSO costs	Owner of the line (no socialization)	Owner of the line	Equal share
XB relevance definition	CNECs considered in CCM (with at least 10% PTDF threshold)	Tie line + directly connected line	CNECs considered in CCM with PTDF >= 5%

Source: *Experimentation Report, Section 2.2.1 Base scenarios, p.19*

¹⁸⁴ All Core TSOs declared in their Explanatory Note on the Core RDCTCS Methodology of February 2019 that “[t]his experimentation cannot support all possible scenarios. Indeed, the multiplicity of the above described options is likely to lead to a number of different scenarios so high that they could not reasonably be computed”. The objective of the Core TSOs was to investigate “the different possibilities that can be used to apply the polluter pays principle via the experimentation” and “to explore several ways of applying the methodology, by varying its parameters”.

Table 2: Sensitivity analysis of All Core TSOs' Experimentation Report.

	Green	Blue 1 (LF th: equal w/ credit)	Blue 2 (LF th: proportional)	Yellow
Scenarios execution	V		V	V
Sensitivity analysis XBRNE threshold change vs. results influence	V		V	X
Sensitivity analysis LF threshold change vs. results influence	V	V	V	X
Sensitivity analysis IF change vs. results influence	X		V	X
Sensitivity analysis IF+LF threshold change vs results influence	X	X	X	V

Source: Experimentation Report, Section 2.2.2 Sensitivity Analysis, p.19

Table 3: Timestamps of All Core TSOs' Experimentation Report.

Timestamp	Label
2018-11-21 06:30	TS1
2018-11-30 10:30	TS2
2019-02-03 23:30	TS3
2019-03-18 19:30	TS4
2019-04-18 16:30	TS5
2019-04-22 15:30	TS6
2019-05-08 08:30	TS7
2019-06-24 09:30	TS8
2019-07-22 13:30	TS9
2019-07-23 16:30	TS10

Source: Experimentation Report, Section 2.3 Input data description, p.20

883. ACER carried out its own simulations of the options on the basis of the arguments that had been put forward by All Core NRAs and All Core TSOs during the consultation phase. The main parameters investigated by ACER in this additional analysis were (i) IF and LF thresholds and (ii) IF and LF priorities in the order-stack, creating 7 additional scenarios (Tables 4, 5 and 6). The second, third and sixth lines of each of the tables, entitled “internal flow (IF) threshold (Y)”, “Core Loop Flow (LF) threshold (X)” and “Order Stack” evidence the priority stack variations that were carried out in the additional scenarios of ACER’s own simulation.

Table 4: Additional scenarios of ACER’s own simulation (GREEN, GREEN SENSI 2 and GREEN SENSI 4 scenarios).

Options	Green	Green sensi 2	Green sensi 4
Netting	Equal with credit	Equal with credit	Equal with credit
Internal Flow (IF) threshold (Y)	Y = 0% (no threshold)	Y = 0% (no threshold)	Y = 0% (no threshold)
Core Loop Flow (LF) Threshold (X)	X = 10%	X = 15%	X = 10%
Cost sharing principle (cost allocation) for Allocated Flow (AF)	Owner pays	Owner pays	Owner pays
Cost sharing principle (cost allocation) for Core LF < X	Owner pays	Owner pays	Owner pays
Order-stack	LF > X (Polluter pays); IF (Owner pays); Core LF < X (Owner pays); AF + PST (Owner pays)	LF > X (Polluter pays); IF (Owner pays); Core LF < X (Owner pays); AF + PST (Owner pays);	LF > X (Polluter pays); IF (Owner pays); Core LF < X (Owner pays); AF + PST (Owner pays);

Application Core LF Threshold (common to individual)	Equal splitting with credit	Equal splitting with credit	Equal splitting with credit
Cost sharing principle (cost allocation) for Non-Core LF	Owner pays	Owner pays	Owner pays
Definition of cross-border relevant network element	CNECs considered in the capacity calculation methodology (with a PTDF \geq 10%)	CNECs considered in the capacity calculation methodology (with a PTDF \geq 10%)	CNECs considered in the capacity calculation methodology (with a PTDF \geq 15%)

Source: Paragraph 101 of the Defence, referring to its Annex 24, which includes ACER's e-mail of 21 July 2020 to All Core NRAs and All Core TSOs and the annexed excelsheet containing "Scenarios ACER."

Table 5: Additional scenarios of ACER's own simulation (ACER SCEN.1, ACER SCEN.2 and ACER SCEN.3 scenarios).

Options	ACER Scen. 1	ACER Scen. 2	ACER Scen. 3
Netting	No netting	No netting	No netting
Internal Flow (IF) threshold (Y)	X+Y = 20% (after deduction of non-Core LFs, min X+Y = 10%)	X+Y = 20% (after deduction of non-Core LFs, min X+Y = 10%)	X+Y = 20% (after deduction of non-Core LFs, min X+Y = 10%)
Core Loop Flow (LF) Threshold (X)	X+Y = 20% (after deduction of non-Core LFs, min X+Y = 10%)	X+Y = 20% (after deduction of non-Core LFs, min X+Y = 10%)	X+Y = 20% (after deduction of non-Core LFs, min X+Y = 10%)
Cost sharing principle (cost allocation) for Allocated Flow (AF)	Owner pays	Owner pays	Owner pays
Cost sharing principle (cost allocation) for Core LF < X	Owner pays	Owner pays	Owner pays
Order-stack	LF > X (Polluter pays); IF > Y (Owner pays); LF < X (Owner pays); IF < Y (Owner pays); AF (Owner pays); PST (Owner pays)	LF, IF > Ind. Thr. (Polluter pays; Owner pays); LF, IF < Ind. Thr. (Owner pays); AF (Owner pays); PST (Owner pays)	LF, 50%IF > Ind. Thr. (Polluter pays; Owner pays); LF, 50%IF < Ind. Thr. (Owner pays); AF (Owner pays); PST (Owner pays)
Application Core LF Threshold (common to individual)	Equal splitting with credit	Equal splitting with credit	Equal splitting with credit
Cost sharing principle (cost allocation) for Non-Core LF	Owner pays	Owner pays	Owner pays
Definition of cross-border relevant network element	All XNEs	All XNEs	All XNEs

Source: Paragraph 101 of the Defence, referring to its Annex 24, which includes ACER's e-mail of 21 July 2020 to All Core NRAs and All Core TSOs and the annexed excelsheet containing "Scenarios ACER."

Table 6: Additional scenarios of ACER's own simulation (ACER SCEN.4, ACER SCEN.5, ACER SCEN.6 and ACER SCEN.7 scenarios).

Options	ACER Scen. 4	ACER Scen. 5	ACER Scen. 6	ACER Scen. 7
Netting	No netting	No netting	No netting	No netting
Internal Flow (IF) threshold (Y)	Y = 0% (no threshold)	Y = 0% (no threshold)	Y = 0% (no threshold)	Y = 0% (no threshold)
Core Loop Flow (LF) Threshold (X)	X = 10%	X = 10%	X = 10%	X = 15%
Cost sharing principle (cost allocation) for Allocated Flow (AF)	Owner pays	Owner pays	Owner pays	Owner pays
Cost sharing principle (cost allocation) for Core LF < X	Owner pays	Owner pays	Owner pays	Owner pays
Order-stack	LF > X (Polluter pays); IF > Y (Owner pays); LF < X (Owner pays); IF < Y (Owner pays); AF (Owner pays); PST (Owner pays)	LF, IF > Ind. Thr. (Polluter pays; Owner pays); LF, IF < Ind. Thr. (Owner pays); AF (Owner pays); PST (Owner pays)	LF, 50%IF > Ind. Thr. (Polluter pays; Owner pays); LF, 50%IF < Ind. Thr. (Owner pays); AF (Owner pays); PST (Owner pays)	LF, 25%IF > Ind. Thr. (Polluter pays; Owner pays); LF, 25%IF < Ind. Thr. (Owner pays); AF (Owner pays); PST (Owner pays)
Application Core LF Threshold (common to individual)	Equal splitting with credit	Equal splitting with credit	Equal splitting with credit	Equal splitting with credit
Cost sharing principle (cost allocation) for Non-Core LF	Owner pays	Owner pays	Owner pays	Owner pays

Definition of cross-border relevant network element	All XNEs	All XNEs	All XNEs	All XNEs
--	----------	----------	----------	----------

Source: Paragraph 101 of the Defence, referring to its Annex 24, which includes ACER's e-mail of 21 July 2020 to All Core NRAs and All Core TSOs and the annexed excel sheet containing "Scenarios ACER."

884. Tables 4, 5 and 6 evidence that the following priority stack scenarios were considered:

- GREEN: 10% LF + IF priority 0%
- GREEN_SENSI_2: 15% LF + IF priority 0%
- GREEN_SENSI_4: 10% LF + IF priority 0%
- ACER SCEN.1: 20% LF + IF priority 0%
- ACER SCEN.2: 20% LF + IF priority 100%
- ACER SCEN.3: 20% LF+ IF priority 50%
- ACER SCEN.4: 10% LF+ IF priority 0%
- ACER SCEN.5: 10% LF+ IF priority 100%
- ACER SCEN.6: 10% LF+ IF priority 50%
- ACER SCEN.7: 15% LF+ IF priority 25%

885. ACER discussed the results of its own simulations during consultation to allow All Core TSOs and All Core NRAs to consider the concrete impact of these choices and options, as set out in paragraph 24 of the Contested Decision: "During the close cooperation phase between ACER and all Core regulatory authorities and TSOs as detailed in paragraph (11) above, and beyond the above-mentioned issues, ACER: (...) (e) provided simulation results for all the choices and options which were discussed during consultation to allow the TSOs and regulatory authorities to consider the concrete impact of these choices and options; (...)". ACER's Defence summarises the results of ACER's own simulations of July 2020 including 3 base scenarios and 2 sensitivity analysis for the green scenarios (i.e. the scenario "GREEN_SENSI_2" where the LF threshold was increased from 10% to 15% and (ii) the scenario "GREEN_SENSI_4" where the PTDF threshold was increased from 10% to 15%), as show in Table 7.

Table 7: Cost shares (in %) for coordinated RAs taken during 10 timestamps of All Core TSOs' RDCTCS Experimentation Report for ACER's simulations.

Scenario (%)	AT	BE	CZ	DE	FR	HR	HU	NL	PL	RO	SI	SK	TOTAL
GREEN	21,2%	0,3%	1,2%	68,9%	8,1%	-0,5%	0,0%	0,0%	0,9%	0,0%	-0,2%	0,2%	100,0%
GREEN SENSI 2	21,1%	0,4%	1,2%	69,8%	7,0%	-0,6%	0,1%	0,1%	1,0%	0,0%	-0,3%	0,2%	100,0%
GREEN SENSI 4	21,1%	0,3%	1,2%	66,7%	8,1%	-0,5%	0,0%	2,9%	0,3%	0,0%	-0,2%	0,2%	100,0%
YELLOW	21,5%	0,5%	-2,4%	57,9%	5,6%	-0,7%	0,2%	6,0%	11,2%	0,0%	-0,2%	0,4%	100,0%
BLUE	14,7%	1,4%	1,2%	56,5%	11,6%	1,3%	2,5%	3,6%	2,5%	1,2%	1,4%	2,0%	100,0%
ACER Scen. 1	22,6%	0,4%	1,2%	67,8%	6,5%	-0,5%	0,0%	0,9%	1,1%	0,0%	-0,2%	0,1%	100,0%
ACER Scen. 2	22,6%	0,4%	0,6%	64,3%	6,5%	-0,5%	0,0%	3,4%	2,7%	0,0%	-0,2%	0,1%	100,0%
ACER Scen. 3	22,6%	0,4%	0,8%	65,6%	6,5%	-0,5%	0,0%	2,6%	1,9%	0,0%	-0,2%	0,1%	100,0%
ACER Scen. 4	19,8%	0,5%	1,0%	69,5%	7,6%	-0,4%	0,0%	0,9%	1,0%	-0,1%	-0,1%	0,5%	100,0%
ACER Scen. 5	19,6%	0,5%	0,4%	65,3%	7,6%	-0,4%	0,0%	3,7%	3,0%	-0,1%	-0,1%	0,4%	100,0%
ACER Scen. 6	19,7%	0,5%	0,6%	66,7%	7,6%	-0,4%	0,0%	2,9%	2,1%	-0,1%	-0,1%	0,5%	100,0%
ACER Scen. 7	21,3%	0,4%	1,0%	66,4%	7,7%	-0,5%	0,0%	2,1%	1,6%	0,0%	-0,1%	0,2%	100,0%
Average	20,6%	0,5%	0,7%	65,4%	7,5%	-0,4%	0,2%	2,4%	2,5%	0,1%	-0,1%	0,4%	100,0%
Minimum	14,7%	0,3%	-2,4%	56,5%	5,6%	-0,7%	0,0%	0,0%	0,3%	-0,1%	-0,3%	0,1%	100,0%
Maximum	22,6%	1,4%	1,2%	69,8%	11,6%	1,3%	2,5%	6,0%	11,2%	1,2%	1,4%	2,0%	100,0%

Source: Paragraph 102 of the Defence, referring to its Annexes 24 and 87.

886. The parameters of ACER SCEN.4, highlighted in grey in Table 7 correspond to the parameters of the Contested Decision if mapping solution iVBM had been adopted. However, it does not correspond to the scenario of the Contested Decision because the Contested Decision did not adopt mapping solution iVBM but mapping solution LCBM.

887. The variations of the priority stack with a 10% LF threshold are contained in ACER SCEN.5 (all IFs get equal priority as LFs above the threshold) and ACER SCEN.6 (50% IFs get equal priority as LFs above the threshold). ACER SCEN.7 contains a variation of both the LF

threshold (15% instead of 10% LF) and the priority stack (25% IFs get equal priority as LFs above the threshold).

In August 2020, ACER performed new simulations for ACER SCEN.4 scenario, whereby the only difference was a different mapping solution (LCBM), as shown below in Table 8.

Table 8: Cost shares (in %) for coordinated RAs taken during 10 timestamps of All Core TSOs' RDCTCS Experimentation Report under ACER scenario 4, comparing iVBM mapping and LCBM mapping.

Mapping	AT	BE	CZ	DE	FR	HR	HU	NL	PL	RO	SI	SK	Sum
iVBM old	19,8%	0,5%	1,0%	69,5%	7,6%	-0,4%	0,0%	0,9%	1,0%	-0,1%	-0,1%	0,5%	100,0%
LCBM	11,9%	0,3%	17,1%	60,4%	1,8%	0,2%	0,0%	3,5%	4,3%	0,0%	0,0%	0,6%	100,0%

Source: Paragraphs 103 of the Defence, referring to its Annexes 24 and 87.

888. In March 2021, after the Appeals had been submitted by the Appellants, ACER carried out an additional analysis to simulate the influence of the variation of the LF threshold and of the IF prioritisation % under the LCBM mapping of the Contested Decision because such variations had not yet been simulated¹⁸⁵. The results are shown in Table 9, which adds an additional line to ACER's simulations of August 2020:

Table 9: Cost shares (in %) for coordinated RAs taken during 10 timestamps of All Core TSOs' RDCTCS Experimentation Report under ACER scenario 4, comparing (1) August 2020 simulations with iVBM mapping; (2) August 2020 simulations with LCBM mapping and (3) March 2021 simulation with LCBM mapping.

Mapping (cost shares %)	AT	BE	CZ	DE	FR	HR	HU	NL	PL	RO	SI	SK	Sum
1 ACER SC4. iVBM old August 2020	19,8%	0,5%	1,0%	69,5%	7,6%	-0,4%	0,0%	0,9%	1,0%	-0,1%	-0,1%	0,5%	100,0%
2 ACER SC4. LCBM August 2020	11,9%	0,3%	17,1%	60,4%	1,8%	0,2%	0,0%	3,5%	4,3%	0,0%	0,0%	0,6%	100,0%
3 ACER SC4. LCBM March 2021	10,8%	0,1%	14,9%	61,5%	2,0%	0,3%	0,0%	7,2%	3,1%	0,0%	0,0%	0,2%	100,0%

Source: Paragraphs 505 and 506 of the Defence, referring to its Annexes 28, 86 and 87.

889. ACER scenarios SCEN.4, SCEN. 5 and SCEN.6 according to ACER's March 2021 simulations¹⁸⁶ gave the following results.

Scenario (%)	AT	BE	CZ	DE	FR	HR	HU	NL	PL	RO	SI	SK	TOTAL
ACER Scen. 4 LCBM March 2021 CoTh10% IFprior0%*	10,8%	0,1%	14,9%	61,5%	2,0%	0,3%	0,0%	7,2%	3,1%	0,0%	0,0%	0,2%	100,0%
ACER Scen. 5 LCBM March 2021 ComTh10% IFprior100%**	10,4%	0,1%	14,1%	67,0%	1,8%	0,3%	0,0%	3,2%	3,0%	0,0%	0,0%	0,1%	100,0%
ACER Scen. 6 LCBM March 2021 ComTh10% IFprior50%***	10,6%	0,1%	14,4%	65,2%	1,8%	0,3%	0,0%	4,4%	3,1%	0,0%	0,0%	0,2%	100,0%

Source: ACER's Defence and Annex 86 to ACER's Defence.

* ACER Scenario 4 LCBM March 2021 ComTh10% IFprior0% is equivalent to the cost sharing methodology under the Contested Decision with the updated input of March 2021.

** ACER Scenario 5 LCBM March 2021 ComTh10% IFprior100%" provides cost sharing results where LFs and IFs are equally prioritised.

*** ACER Scenario 6 LCBM March 2021 ComTh10% IFprior50%" provides cost sharing results where 50% of IFs are equally prioritised with LFs.

ACER Scen.4 is the scenario of the Contested Decision.

¹⁸⁵ As confirmed in ACER's reply to the Board of Appeal's Third Request for Information, the simulations of March 2021 were done on the basis of the inputs used in ACER's simulation of August 2020 following the correction of a clerical error. This is set out in para 505 and footnotes 291 and 548 of the Defence and in Annex 99 to ACER's Rejoinder.

¹⁸⁶ Defence, para 602 and Annex 86 to the Defence.

ACER Scen.5 includes all IFs as no.1 of the priority list alongside LFs above the threshold.
ACER Scen.6 includes 50% IFs as no.1 of the priority list alongside LFs above the threshold.

A comparison of all three scenarios leads to the following conclusions for the German BZ and the French BZ:

-German BZ: cost share increase of respectively 5.5% and 3.8% if IFs are totally or partially prioritised.

-French BZ: cost share decrease of 0.2% if IFs are totally or partially prioritised.

890. The above simulation evidences that a large BZ such as France has a considerably lower cost share than a large BZ such as Germany. Therefore, LF prioritisation does not discriminate against larger BZs *per se*. It also evidences, secondly, that a change in the priority – e.g. prioritising 50% of IFs or all IFs – does not significantly decrease France’s cost share and would even increase Germany’s cost share.
891. This leads to the conclusion that the important cost share of Germany is not due to the fact that it is a large BZ and that LF prioritisation discriminates against large BZs. The high cost share of Germany must therefore be related to other causes (these could be, *inter alia*, network deficiencies that generate a high level of LFs). The Board of Appeal refers to the Twelfth Consolidated Plea, where compliance with the principle of non-discrimination is analysed in detail.
892. Placing IFs as no.2 of the priority list does not discriminate against LF-causing TSOs, who would have to pay for costs that are provoked by IFs instead of LFs, as set out in Sub-Pleas 6.3 and 6.4.
893. Placing IFs as no.2 of the priority list does not discriminate against TSOs that are managing IFs effectively and efficiently, as set out in Sub-Pleas 6.6, 6.10 and 6.14. Regarding Appellant VI’s claim that Article 16(13) ER only applies to XNEs, which justifies in itself their different treatment from other NEs, the Board of Appeal refers to the First Consolidated Plea regarding the RDCTCS scope and the inclusion of internal XNECs in the RDCTCS scope.
894. Placing IFs as no.2 of the priority stack does not discriminate in view of alleged requirements of equality between LFs and IFs to be found in Article 16(8) and (13) ER, as set out in Sub-Plea 6.12. Regarding Appellant IV’s position paper, Appellant IV’s starting-point is erroneous, as set out in Sub-Pleas 6.3 and 6.14
895. Placing IFs as no.2 of the priority stack does not discriminate in relation to Article 74(6)(a) and (b) CACM, as set out in Sub-Pleas 6.6, 6.8 and 6.9.
896. Appellant II provides the following evidence: (i) Confidential Data Treatment of Appellant VI, comparing the contribution of IFs to congestion to the contribution of LFs to congestion in terms of volume and (ii) two theoretical examples to illustrate that with the Contested Decision’s RDCTCS, the majority of RA costs or even all RA costs are allocated to LFs.
897. The theoretical examples are provided to illustrate that the Contested Decision’s RDCTCS allocates costs to BZs generating LFs on NEs facing high levels of IFs, even though the contribution of the LFs to the volume of the congestion is marginal.

Example 1: The first example considers a network element on which cross-zonal flows, internal flows and loop flows represent 50%, 50% and 35%, respectively. Flows on this network element therefore amount to 135% of Fmax, corresponding to an overload of 35%. Polluting flows amount to 85% of the load on the network element - internal flows and loop flows representing 59% and 41% of these polluting flows, respectively, as plotted in the left-hand side graph of Figure 4 below. With the cost sharing design of the contested decision, 71% of RDCT costs will be allocated to loop flows, the remaining 29% being borne by internal flows, as plotted in the right-hand side graph of Figure 4 below:

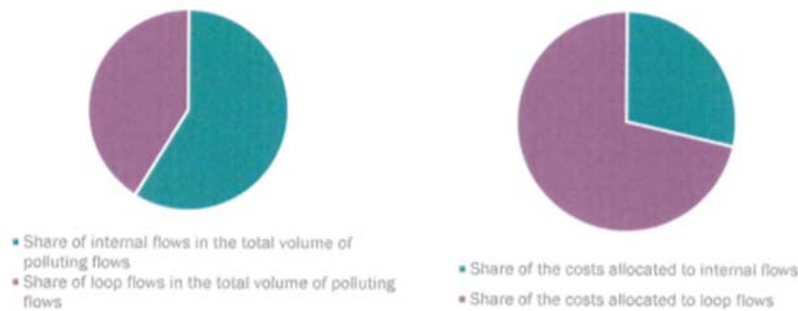

Figure 4 – Relative volume of congestion and cost sharing share of internal flows and loop flows in theoretical example 1

Example 2: The second example considers a network element on which cross-zonal flows, internal flows and loop flows represent 50%, 35% and 35%, respectively. Flows on this network element amount to 120% of F_{max} , corresponding to an overload of 20%. Polluting flows amount to 75% of the load on the network element - internal flows and loop flows representing both half of these polluting flows, as plotted in the left-hand side graph of Figure below. Yet, with the current cost sharing design, loop flows would bear 100% of the RDCT costs, as plotted in the right-hand side graph of Figure 5 below:

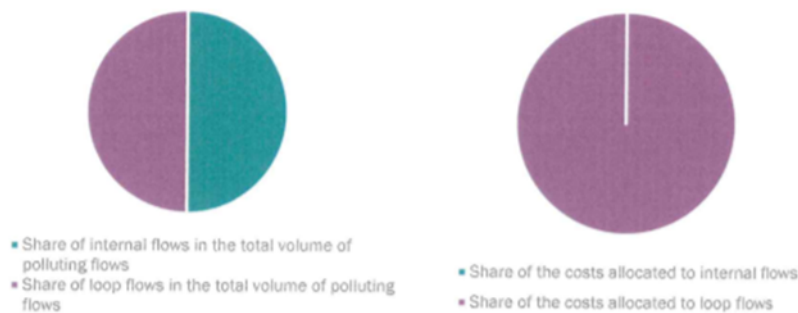

Figure 5 – Relative volume of congestion and cost sharing share of internal flows and loop flows in theoretical example 2

Source: Appeal of Appellant II, paragraph 100.

898. With respect to these theoretical examples, the Board of Appeal refers to Sub-Pleas 6.3 and 6.4 above, which set out the reasons why, even if LFs and IFs are present on a congested NE, LFs above the threshold are the primary contributors to the congestion. Reasoning otherwise erroneously reverses the PPP and applies it to the LF-hosting TSOs, which Article 16(13) ER does not identify as polluters that should contribute to the RDCTCS. In the absence of IFs or LFs from polluting flow causing TSOs, the internal NEs of the polluting flow hosting TSOs would not be congested. Article 16(13) ER does not define pollution as a lack of maintenance or investment. Pollution is clearly defined as the contribution to the congestion through electricity flows. LF prioritisation duly reflects the fact that LFs above the threshold are the primary contributors to the congestion on internal NEs. This is not a quantitative criterion but a qualitative criterion

899. Regarding Appellant VI's claim that ACER should not have used the results of All Core TSOs' RDCTCS Experimentation Report when carrying out its own simulations because of its deficiencies, the Board of Appeal notes this is contradictory with the fact that Appellant VI's financial assessment attached as Confidential Annex A.6 to its appeal is also based on All Core TSOs' RDCTCS Experimentation Report. In addition, ACER did not rely upon All Core TSOs' RDCTCS Experimentation Report but duly took account of that report when carrying out its own assessment and own simulations.

900. The Board of Appeal refers to the Eleventh Consolidated Plea, Sub-Plea 11.4, regarding the assessment of the data provided by Appellant VI in relation to the proportionality principle.

901. In light of the above, the Board of Appeal concludes that the prioritisation of LFs above the threshold set by ACER in the Contested Decision is lawful.

6.17 Prioritisation of LFs above the threshold infringes Article 74(2) CACM.

902. Appellant IV claims that the prioritisation of LFs above the threshold infringes Article 74(2) CACM, which requires the RDCTCS to “include cost-sharing solutions for actions of cross-border relevance”. It holds that RDCT costs triggered by IFs are by their very nature not costs for XRAs but costs for RAs of domestic relevance.

903. The Board of Appeal refers to the First Consolidation Plea, which deals with the RDCTCS scope and the definition of CB relevance. The RDCTCS scope is not restricted to interconnectors (XNEs located on a BZB) or tie-lines. Consequently, the RDCTCS applies to both LFs and IFs. All XNEs should be included, also internal XNEs (which host and cause a variety of flows, not only IFs).

904. It follows that the Sixth Consolidated Plea must be dismissed as unfounded.

905. Appellants’ claims on an infringement of the principle of proportionality are dealt with in the Eleventh Consolidated Plea.

906. Appellants’ claims on an infringement of the principle of non-discrimination are dealt with in the Twelfth Consolidated Plea.

907. Appellants’ claims on ACER’s competence are dealt with in the Fourteenth and Fifteenth Consolidated Pleas.

908. Appellants’ claims on a violation of the duty to reason are dealt with in the Seventeenth Consolidated Plea.

Seventh Consolidated Plea – Threshold for acceptable loop flows.

909. Appellant I¹⁸⁷ alleges that a correct LF threshold level requires a correct calculation – and not an overestimation - of LFs for importing zones: if the overestimated LFs of importing zones are reduced to their correct level, the total burdening LFs above the threshold (both from exporting and importing zones) will also be reduced. It claims that the threshold for acceptable LFs set by ACER at 10% should be lowered in order to keep the ratio between the PPP and the OPP. Appellant I claims that its opinion is in line with All Core TSOs’ Non-Paper¹⁸⁸, in which Core TSOs indicated a preference for a LF threshold of 5% as the highest value. It alleges an infringement of Articles 74(6)(c) and (i) CACM and 16(13) ER.

910. Appellant II¹⁸⁹ alleges that the common threshold for acceptable LFs stipulated in Article 7(3) of the Contested Decision’s RDCTCS should have been the outcome of a prior study performed by All Core TSOs and approved by All Core NRAs in accordance with Article 16(13) ER. In its opinion, only this prior study could have ensured that the common threshold for acceptable LFs of the RDCTCS complies with (i) Article 16(13) ER, which neither allows for a temporary solution without prior study nor for a common thresholds for all BZBs but mandates a threshold for each individual BZB, (ii) the requirements of Article 74 CACM, i.e. that costs need to be allocated in a manner that is transparent and auditable, fair and consistent with the responsibilities and liabilities of TSOs (each BZ generates structurally different LFs depending on their size, location and topological characteristics, e.g. the location of the generation plants and volume of imports/exports) -; and (iii) the principles of transparency and non-discrimination. In its opinion, the RDCTCS’ implementation should have been postponed and such postponement would not have prevented a timely implementation of the RDCT because RDCTCS optimisation tools needed to implement the RDCTCS will only be operational at the earliest at the end of 2024. Finally, Appellant II claims that the threshold

¹⁸⁷ Appeal I, Plea 2, paras 30-34.

¹⁸⁸ Appeal I, Plea 2, paras 30-34.

¹⁸⁹ Appeal II, Plea 5, paras 107-121.

should not only apply to LFs but also to IFs because it opposes the prioritisation of LFs above the threshold.

911. Appellant III¹⁹⁰ alleges that the common threshold for acceptable LFs stipulated in Article 7(3) RDCTCS lacks a legal basis. It also infringes, in its opinion, Article 16(13) and (8) ER because (i) it is a common threshold for all BZBs and not an individual threshold for each BZB; (ii) it should have been based on a prior study by All Core TSOs; (iii) its value of 10% is too low whilst no long-term threshold has been set given the fact that Article 16(8) ER and Article 10(5) Core CCM foresee a 30%-threshold and account has to be taken of national characteristics, e.g. high renewable generation in larger BZs, which lead to comparably more LFs and (iv) is discriminatory towards large BZs.
912. Appellant IV¹⁹¹ claims that the common threshold for acceptable LFs stipulated in Article 7(3) of the Contested Decision's RDCTCS infringes (i) the requirement to be consistent with the responsibility of the TSOs to use up to 30% of the capacity for LFs, contrary to Articles 74(6)(b) CACM and 16(8) and (13) ER; (ii) the requirement to facilitate adherence to the responsibility of the TSOs to use up to 30% of the capacity for LFs pursuant to Article 74(6)(f) CACM; and (iii) the requirement to be consistent with the responsibility and liability of the TSOs to define a legitimate level of LFs under Article 16(13) ER as well as 74(6)(b) CACM Regulation. Appellant IV also alleges that the common LF threshold of the Contested Decision's RDCTCS infringes the principle of conferral pursuant to Articles 5(1) and (2) TFEU. Finally, Appellant IV claims that the equal splitting of the common LF threshold among all LFs from Core BZs infringes (i) the fair distribution of costs principle under Article 74(6)(c) CACM, (ii) the principle of non-discrimination Article 74(6)(i) and Article 3(e) CACM and (iii) the requirement to facilitate adherence to the general principles of CM under Article 74(6)(f) CACM, including with regard to the principles laid down in Article 70 and Article 16(8) and (13) ER, including the PPP.
913. Appellant V¹⁹² claims that the common LF threshold of 10% set by ACER is unlawful because (i) the threshold is contrary to Articles 16(8) and (13) ER in conjunction with Recital (28) ER, which allow for a 30%-threshold; (ii) ACER deviates from the 30%-threshold without a technical justification, contrary to Articles 16(8) and (13) ER; (iii) it indirectly penalises flows that Article 16(8) ER explicitly considers permissible; (iv) it infringes Article 15(2) ER, which grants TSOs the possibility that non-CZ trade flows (i.e., primarily LFs) may even exceed 30% of the interconnection capacity in the transitional phase of an AP; (v) violates the principle of proportionality (Article 5(4) TEU and Recital 45 ACER Regulation); (vi) constitutes an excess of competence by ACER, which made an error of assessment and implemented a majority decision of the TSOs, contrary to Article 9(3) CACM; and (vii) infringed the right to be heard (Article 41 Charter and Article 14(6) ACER Regulation) by failing to consult the TSOs and not giving them the opportunity to set out their views on ACER's interpretation of the TSOs' expert opinion.
914. Appellant VI¹⁹³ claims that the legitimate LF threshold set by ACER is unlawful and does not comply with Article 16(8) and (13) ER because (i) it is a common LF threshold whereas Article 16(13) ER requires a LF threshold per BZ, (ii) it should have been preceded by a due analysis by Core TSOs, (iii) it should also apply to IFs and (iv) should be based on the maximum limit of Article 16(8) ER.
915. In its Defence¹⁹⁴, ACER responds that (i) it was competent to set a common threshold and did not infringe the principle of conferral; (ii) ACER's competence is not altered by the requirement of a prior study to be performed by TSOs in Article 16(13) ER; (iii) the

¹⁹⁰ Appeal III, Plea 2, paras 126-158.

¹⁹¹ Appeal IV, Plea 3, paras 93-130.

¹⁹² Appeal V, Plea 3, paras 179-218.

¹⁹³ Appeal VI, Plea 3, paras 167-170.

¹⁹⁴ Defence, paras 432-589.

legitimate LF threshold set by the Contested Decision is in accordance with Articles 15(2), 16(8) and 16(13) ER and with the principles of proportionality and non-discrimination; (iv) the determination of a common LF threshold for all BZs to be split into individual thresholds for each BZB is in line with Article 16(13) ER; (v) Article 16(13) ER does not require a threshold for IFs; (vi) ACER made no error or assessment in determining the common LF threshold; (vii) ACER did not infringe the right to be heard; (viii) the individual LF threshold is in line with the principle of fair distribution of costs and the principle of non-discrimination, as well as all principles of Article 16 ER.

916. Intervener I intervenes in the Seventh Consolidated Plea on behalf of Appellant III.

917. Interveners II, III, IV, V and VI intervene in the Seventh Consolidated Plea on behalf of the Defendant.

918. At the Oral Hearing, most Appellants challenged the one-size-fits-all nature of a common LF threshold and alleged that ACER's simulations are not future-proof, especially given the expectations of dynamic market developments (e.g. an increasing usage of RES). Appellant I held, in this respect, that a common LF threshold should not be based on past market outcomes, especially since the future market will be very dynamic.

7.1 Characteristics of the legitimate LF threshold.

919. Article 2(2)(a), (o), (p) and (s) of the Contested Decision's RDCTCS defines the following flows:

920. Article 7(1) to (5) of the Contested Decision's RDCTCS, entitled "*Distribution of costs on XNECs to TSOs*" contains a legitimate LF threshold:

"1. All Core TSOs shall use the flow components on each eligible XNEC to calculate the share of the total costs attributed to eligible XNEC that shall be attributed to each TSO from the Core CCR. The calculations shall consist of the following steps:

- i. Application of threshold(s) as described in paragraphs 2 to 5;*
 - ii. Identification of contributions to congestion as described in paragraph 6; and*
 - iii. Distribution of costs to bidding zones and TSOs as described in paragraphs 7 and 8.*
- 2. First, all Core TSOs shall split the burdening loop flow by each bidding zone within the Core CCR on each eligible XNEC in two parts: one part will define the burdening loop flow below the individual threshold and the other part the burdening loop flows above the individual threshold as defined in paragraph 4.*
- 3. To calculate the individual threshold for burdening loop flows from each bidding zone within the Core CCR on each eligible XNEC, all Core TSOs shall first calculate a common threshold for burdening loop flows from all bidding zones within the Core CCR on each eligible XNEC. This common threshold shall be equal to 10% of the F_{max} for each eligible XNEC.*
- 4. All Core TSOs shall calculate an individual threshold for burdening loop flows for each bidding zone within the Core CCR for each eligible XNEC, by dividing the common threshold as defined in paragraph 3 equally among all burdening loop flows from bidding zones within the Core CCR. If any burdening loop flow from any bidding zone within the Core CCR is below such calculated individual threshold, the individual threshold can be increased, such that the sum of all burdening loop flows (from all bidding zones within Core CCR) below the individual threshold is equal to the common threshold as defined pursuant to paragraph 3.*
- 5. The individual threshold pursuant to paragraph 4 is without prejudice to the determination of the level of loop flows that could be expected without structural congestion in a bidding zone and that is to be determined in accordance with Article 16(13) of the Electricity Regulation. Once this level is approved, it shall automatically replace the individual threshold as defined in paragraph 4."*

921. The Contested Decision's RDCTCS sets a **threshold for legitimate LFs**. In accordance with Article 16(13) ER and the PPP, costs for XRAs are allocated to those TSOs in whose BZs the flows that contributed to the congestion originated. Only LFs above the threshold are penalised: only costs caused by LFs above the threshold shall be borne solely by the TSOs that caused the LFs. Costs caused by LFs below the threshold are shared jointly between All Core TSOs.

922. The threshold for legitimate LFs of the Contested Decision's RDCTCS is **temporary**. It will automatically be replaced by a new threshold commonly determined by All Core TSOs and approved by All Core NRAs. The Contested Decision's RDCTCS does not set any time restrictions upon Core TSOs and NRAs to adopt a definitive legitimate LF threshold replacing

the temporary threshold of the Contested Decision's RDCTCS. This implies that All Core TSOs and NRAs could adopt a definitive legitimate LF threshold before the actual implementation of the RDCTCS and avoid the implementation of the temporary threshold all in all. In other terms, ACER left it up to All Core TSOs to determine the legitimate LF threshold but, in the absence of such timely determination, ensured an interim solution in order not to jeopardise the implementation of the RDCTCS. The implementation of the interim solution could still be avoided by All Core TSOs as soon as they would agree on a definitive legitimate LF threshold to replace ACER's temporary threshold. All Core TSOs' could even agree to determine a legitimate LF threshold before the implementation of the RDCTCS in order to avoid any use of ACER's temporary threshold at all. The Board of Appeal notes that no steps have been taken by Core TSOs to determine a legitimate LF threshold since the adoption of the Contested Decision¹⁹⁵.

923. The threshold for legitimate LFs of the Contested Decision's RDCTCS is a **2-step threshold**. In a first step, a common threshold is set at **10% of the maximum capacity of each eligible XNEC in the Core region**. In a second step, the common threshold is divided between individual Core BZs in order to establish individual legitimate LF thresholds per Core BZ. In order to calculate the individual LF threshold per Core BZ, the common threshold is **split among Core BZs** that create LFs on the concerned NE. The splitting method splits the common LF threshold equally between BZs and provides that, if Core BZs have a level of LFs below the equally divided individual BZ LF threshold (negative value), this negative leftover value of usable but unused LFs can be redistributed to relieve Core BZs having a level of LFs above the threshold. Thus, the individual BZ LF threshold of the relieved Core BZs is increased proportionally to the unused leftovers of structurally not congested BZs. Ultimately the sum of all LFs from all Core BZs below the individual threshold is equal to the common LF threshold of 10%. As set out in the Contested Decision (paragraph 117), the aim is that BZs with a high level of LFs benefit from the fact that BZs with a low level of LFs are not utilising their individual threshold to the full extent. In so doing, the Contested Decision's RDCTCS aims at alleviating any disproportionate burden for larger BZs, e.g. the French BZ or the DE-LU BZ.

7.2 The decision-making process leading-up to the Contested Decision.

924. As will be set out below in the Fourteenth Consolidated Plea, ACER adopted the Contested Decision on the basis of Article 6(10)(a) ACER Regulation and, to this end, it carried out the regulatory supervision of All Core TSOs' RDCTCS Proposal under Article 74 CACM, which stipulates in Article 74(6)(f) that the RDCTCS needs to facilitate adherence to the general principles of CM as set out in Article 16 ER.
925. First, All Core TSOs' RDCTCS Proposal acknowledged the need for a threshold but did not provide further details as to how and to which flow components these thresholds are applied: *"Application of threshold: (a) Application of the threshold(s) per flow type may split individual flow types into two- sub-types"*.
926. In the Explanatory Document accompanying All Core TSOs' RDCTCS Proposal¹⁹⁶, All Core TSOs unanimously agreed on a LF threshold in Section 4.5. The discussion was centred on the parameters of the threshold:
- "4.5.1 Treatment of loop flow.
Loop flows are unscheduled flows and make use of cross-border capacity (indirectly) prior to the Market Flows. For the prioritisation of the different flows identified by the flow decomposition methodology, burdening loop flows are seen as the most critical flows. In accordance with the ACER recommendation and to avoid free-riding of neighbouring countries, those flows should be penalised in the first place in case a XBRNE is overloaded¹⁵. Therefore loop flows are considered as polluters. They are also, individually, associated with only one bidding zone.*

¹⁹⁵ Replies to the Third Request for Information of the Board of Appeal of Appellants I, III, IV, V and VI.

¹⁹⁶ Annex 13 to the Defence.

The electricity network of the Core CCR is highly meshed and in combination with the zonal design of the EU Internal Energy Market a certain level of loop flows is therefore inevitable, even with the most ambitious grid investments. Indeed, such a goal could lead to the target which could be opposite to the goals of internal electricity market (lower investments in cross-border lines). Due to these reasons a threshold for the loop flows could be considered. The consequence of applying a threshold is that a part of the loop flows gets accepted and gets less highly prioritised as the remaining bigger share. This option leads to the following questions:

On what parameter does the threshold apply?

(For the sake of clarity, please find an example in order to grasp the difference between the two possible options or parameters.)(..)”

927. Similarly, All Core NRAs unanimously agreed on the need for a threshold in All Core NRAs' Non-Paper, Section 2.3. The debate was not centred on whether to have a threshold but what the scope of application of the threshold had to be¹⁹⁷: “*In short, all Core NRAs agree that the flows below the defined threshold should be borne by the TSO responsible for the area to which the congested network element belongs.*”

928. Finally, in their Non-Paper (Section 1.9 “*Loop Flow Threshold*”), all Core TSOs also unanimously agreed on the need for a LF threshold¹⁹⁸: “*In accordance with article 16(13) of REGULATION (EU) 2019/943, TSOs have to define the acceptable level of flows resulting from transactions internal to bidding zones. This level of acceptable loop flow is defined by a loop flow threshold.*” The debate was centred on the modalities of such threshold. None of Core TSOs, including the Appellants, tabled a legitimate LF threshold exceeding 15%:

“In accordance with article 16(13) of REGULATION (EU) 2019/943, TSOs have to define the acceptable level of flows resulting from transactions internal to bidding zones. This level of acceptable loop flow is defined by a loop flow threshold.

1.9.1 Core TSO positions

Regarding the loop-flow threshold, the different positions are as follow:

- *9 TSOs support a fix loop-flow threshold for all XBRNEs*
 - *APG, PSE CEPS, ELES, SEPS, Transelectrica: 5%*
 - *ELIA, MAVIR: several % up to 10%*
 - *HOPS: 3%*
- *7 TSOs support a threshold per bidding zone border, but with the different design ideas*
 - *RTE, TenneT DE, TenneT NL, TransnetBW: LF threshold per XBRNE for each bidding zone border*
 - *Amprion, 50Hz, CREOS, TransnetBW: LF threshold per direction.*”

929. The Board of Appeal concludes that, in carrying out its functions of regulatory supervision, ACER had to take account of the fact that All Core TSOs unanimously agreed on the need for a LF threshold, whilst taking due account of the views of All Core NRAs. Furthermore, ACER had to ensure compliance of All Core TSOs' RDCTCS Proposal with Article 74 CACM (especially Article 74(6)(f) CACM) and 16(13) ER).

930. ACER therefore asked All Core TSOs to set the legitimate LF threshold required by Article 16(13) ER in a 4 month deadline (by 20 August 2020). In the absence of compliance by All Core TSOs, ACER was under a duty to ensure compliance with Article 16(13) ER. ACER was not in a position to conduct the in-depth LF analysis required by Article 16(13) ER in a month time (from 20 August 2020, when TSOs did not provide requested analysis at the end of the hearing, until the 6-month deadline for ACER to take the RDCTCS decision, which ended on 27 September 2020). Such in-depth LF threshold study per BZ would have required ACER to first determine a situation with no structural congestion in any BZ. This would have required a protracted analysis of, *inter alia*, network investments and alternative BZ configurations which would address and remove all structural congestions in all Core BZs)

931. Consequently, ACER determined a temporary common threshold for legitimate LFs, following a rigorous analysis of the results from All Core TSOs' Experimentation Report, All Core TSOs' Non-Paper, All Core NRAs' Non-Paper and the results from ACER's own simulations using a variety of parameters.

932. The Contested Decision's RDCTCS clarifies that this threshold is temporary and will automatically be replaced by a new threshold commonly determined by All Core TSOs and

¹⁹⁷ Annex A.3.2 to Appeal VI.

¹⁹⁸ Annex 79 to the Defence.

approved by All Core NRAs. No steps have been taken by Core TSOs to determine a legitimate LF threshold since the adoption of the Contested Decision¹⁹⁹.

7.3 The LF threshold requires a prior study and cannot be temporary.

933. Appellant II alleges that the common threshold for acceptable LFs of the Contested Decision's RDCTCS' should have been the outcome of a prior study performed by All Core TSOs and approved by All Core NRAs in accordance with Article 16(13) ER.
934. Appellant II also alleges that the requirements of Article 74 CACM require such study because costs need to be allocated in a manner that is transparent and auditable, fair and consistent with the responsibilities and liabilities of TSOs, and in line with the principles of transparency and non-discrimination.
935. In Appellant II's view, even though Article 16(13) ER does not set any time-limit within which All Core TSOs need to realise the prior study, in the context of the RDCTCS' decision-making, such prior study clearly had to be performed by All Core TSOs by the regulatory deadline to submit their All Core TSOs' RDCTCS Proposal to NRAs. In its opinion, the RDCTCS' implementation should have been postponed and such postponement would not have prevented a timely implementation of the RDCT because RDCT optimisation tools needed to implement the RDCTCS will only be operational at the earliest at the end of 2024 according to Core TSOs' operational planning. It claims that the availability of RDCT optimisation tools, which are ruled by Articles 35 CACM and 76 SO, is a prerequisite for the implementation of the RDCTCS.
936. Appellant III sets out that a temporary LF threshold triggers the risk that it becomes permanent in case All Core TSOs do not agree, "*permanently undermining NRAs' competences*". Rather than affecting negatively the need for a temporary LF threshold, this actually demonstrates the uncertainty of an agreement between Core TSOs in a short to medium term and, hence, reinforces the need for a temporary LF threshold up until that date.
937. Intervener I observes that ACER was not competent to set a common LF threshold without an analysis being conducted. It observes that this infringes the formal requirement of Article 16(13) ER, which confers the power to approve and analyse the LF threshold to NRAs and not to ACER.
938. As set out in detail in the Fourteenth Consolidated Plea, Sub-plea 14.2, the bottom-up decision-making process provides that the initiative comes from the market (TSOs) but is supervised by regulatory authorities (NRAs or ACER) to ensure adequate regulatory compliance by private companies having private interests, in particular on CB issues. In the present case, All Core NRAs referred decision-making on All Core TSOs' RDCTCS Proposal to ACER on the basis of Article 9(11) CACM.
939. Given that All Core TSOs' RDCTCS Proposal did not contain a legitimate LF threshold as required by Article 16(13) ER, ACER had to ensure compliance with Article 74(6)(f) CACM and Article 16(13) ER. Article 16(13) ER requires that the legitimate LF threshold "*shall be jointly analysed and defined by all transmission system operators in a capacity calculation region for each individual bidding zone border, and shall be subject to the approval of all regulatory authorities in the capacity calculation region*". This is especially so because, as set out in detail in Sub-Plea 14.2 below and acknowledged by All Core NRAs and All Core TSOs, the legitimate LF threshold is indispensable for the RDCTCS.
940. ACER therefore asked All Core TSOs to set the legitimate LF threshold required by Article 16(13) ER in a 4 month deadline but, in the absence of compliance by All Core TSOs, it was under a duty to ensure compliance with Article 16(13) ER and therefore determined a temporary common threshold for legitimate LFs in the amount of 10%, following a rigorous analysis of the results from All Core TSOs' Experimentation Report, All Core TSOs' Non-

¹⁹⁹ Replies to the Third Request for Information of the Board of Appeal of Appellants I, III, IV, V and VI.

Paper, All Core NRAs' Non-Paper and the results from ACER's own simulations using a variety of parameters and following an extensive consultation with Core TSOs and NRAs.

941. The Board of Appeal consequently finds that, even though no prior study was performed by All Core TSOs, ACER duly ensured compliance of All TSOs' RDCTCS Proposal with the applicable regulatory framework, especially Article 16(13) ER, in light of the indispensable nature of the legitimate LF threshold. The Board of Appeal notes, furthermore that, even though it is not based on a prior study by All Core TSOs, the LF threshold set by ACER is not arbitrary but based on a rigorous analysis, as set out in Sub-Pleas 7.2 and 7.14, taking account of available experiments and surveys performed by All Core TSOs on the subject.
942. The 2-step approach of the legitimate LF threshold, set out in Article 7 of the Contested Decision's RDCTCS, is transparent and auditable. It is also consistent with the responsibilities and liabilities of TSOs because it allows Core TSOs precisely to comply with their responsibilities with respect to the RDCTCS under the CACM and the ER, despite their failure to reach an agreement during the decision-making process. As set out in the Twelfth Consolidated Plea, the legitimate LF threshold of the Contested Decision is fair and in line with the principle of non-discrimination.
943. Furthermore, the temporary nature is, contrary to Appellants' claim, compliant with the principle of proportionality, given that ACER allows All Core TSOs and NRAs to set a definitive threshold, having had the benefit of performing an in-depth study on the subject. ACER left it up to All Core TSOs to determine the legitimate LF threshold but, in the absence of such timely determination, ensured an interim solution in order not to jeopardise the implementation of the RDCTCS and, what is more, the implementation of the interim solution could still be avoided by All Core TSOs as soon as they would agree on a definitive legitimate LF threshold to replace ACER's temporary threshold. The Contested Decision's RDCTCS clarifies that this threshold is temporary and will automatically be replaced by a new threshold commonly determined by All Core TSOs and approved by All Core NRAs. The Contested Decision's RDCTCS does not set any time restrictions upon Core TSOs and NRAs to adopt a definitive legitimate LF threshold replacing the temporary threshold of the Contested Decision's RDCTCS. All Core TSOs' could even agree to determine a legitimate LF threshold before the implementation of the RDCTCS in order to avoid any use of ACER's temporary threshold at all. The risk of the temporary threshold becoming permanent, as alleged by Appellant III, is fully left over to All Core TSOs and NRAs. The Board of Appeal notes that no steps have been taken by Core TSOs to determine a legitimate LF threshold since the adoption of the Contested Decision²⁰⁰. As indicated by Interveners II to VI, All Core TSOs are under a duty to develop a proposal for amendment to improve all aspects of the RDCTCS not later than 12 months after its implementation, as per Article 12 of ACER Decision 30/2020's RDCTCS.
944. Appellant II refers in its Reply²⁰¹ to Case C-24/19 to make the generic claim that "*the European Court of Justice considers that studies or evaluations planned prior to a legal decision are compulsory*". The Board of Appeal finds that no analogy can be drawn with Case C-24/19 *A and Others against Gewestelijke stedenbouwkundige ambtenaar van het departement Ruimte Vlaanderen, afdeling Oost-Vlaanderen*²⁰², because the issue at stake was precisely which type of plans, programmes or studies for environmental assessments were compulsory and which were not and because the case is sector-specific and relates to environmental assessments under Directive 2001/42/EC.
945. Appellant II errs when claiming that the setting of a legitimate LF threshold and the RDCTCS' implementation should have been postponed until All Core TSOs' in-depth study

²⁰⁰ Replies to the Third Request for Information of the Board of Appeal of Appellants I, III, IV, V and VI.

²⁰¹ Appellant II's Reply, para 36.

²⁰² Case C-24/19 *A and Others against Gewestelijke stedenbouwkundige ambtenaar van het departement Ruimte Vlaanderen, afdeling Oost-Vlaanderen*, ECLI:EU:C:2020:503.

would have been performed. The statement in Appellant II's Reply that it was compulsory to wait for Core TSOs' study is flawed²⁰³.

946. First, ACER was under a regulatory obligation to take a decision on All TSOs' RDCTCS Proposal by a set deadline and a legitimate LF threshold was an indispensable part of the RDCTCS (Article 6(12) ACER Regulation and 9(11) CACM). The Board of Appeal notes, in this respect, that all deadlines under the applicable energy regulation are compulsory and set by the legislator with specific regulatory objectives in sight. Second, ACER provides email correspondence showing that in August 2020²⁰⁴, Core TSOs had not started performing the study. Third, the Board of Appeal refers to the Tenth Consolidated Plea, which sets out in detail that the implementation timeline of the RDCTCS, the RDCT and the ROSC need to happen simultaneously. Postponing the implementation of the RDCTCS would therefore have postponed the implementation of the RDCT and the ROSC. Given the fact that the first implementation step of all 3 methodologies needs to be done by 4 June 2023 at the latest, Appellant II's statement that the RDCT optimisation tools are "*expected to be robustly developed at the earliest for the end of 2024*" implies that waiting for such tools would cause delays in the implementation of all 3 methodologies.

7.4 The LF threshold's value should not be common but per BZB.

947. Appellant II alleges that Article 16(13) ER does not allow for a common threshold but requires a threshold for each individual BZB and requires to take account of the level of flows that could be expected without structural congestion in each BZ. Appellant II claims that each BZ generates structurally different LFs depending on their size, location and topological characteristics, e.g. the location of the generation plants and volume of imports/exports.

948. Appellant II claims that a common threshold for the Core region is therefore incompatible with Article 74(6)(b) CACM, which requires that the RDCTCS is "*consistent with the responsibilities and liabilities of the TSOs involved.*"

949. Appellant IV claims that there is no legal basis for a temporary common LF threshold because Article 16(13) requires a legitimate LF threshold per BZB. Appellant IV advocates a 30%-threshold and alleges that account has to be taken of national characteristics, e.g. high renewable generation in larger BZs, which lead to comparably more LFs.

950. Appellant V claims that the legitimate LF threshold has to be set for each individual BZB. It alleges that setting the threshold for each individual BZB is important because in an intermeshed system, the LF level depends on network topology, locations of generators and loads and the configuration of BZs. It claims, furthermore, that (i) the different system characteristics of BZs are dynamic and change over time and (ii) in an intermeshed electricity system, bigger BZs are subject to higher transits. Appellant V claims that an equally fixed LF threshold for all BZBs forces BZs to reach the same level of technical characteristics of all BZs, e.g. by influencing the load and generation characteristics or the size of the BZ by merging or splitting respective BZs to reduce LFs.

951. Appellant VI claims that the legitimate LF threshold set by ACER is unlawful because it is a common LF threshold whereas Article 16(13) ER requires a LF threshold per BZ. Appellant VI alleges that a common LF threshold ignores the fact that, as long as the BZ review process provided for in Article 15 ER does not recommend otherwise and the zonal system remains the target model, the cost allocation methodology has to reflect the fact that there are different BZs in terms of size and topology.

952. Intervener I alleges that a common LF threshold contradicts the requirement to differentiate between BZB for each BZ, does not take into account that LFs occur bi-directionally and does not analyse the level of LFs that could be expected without structural congestion in the BZ. In

²⁰³ Reply of Appellant II, para 36.

²⁰⁴ Annex 45 to the Defence.

its view, a LF threshold should comprise the threshold-value per BZ but also the threshold-value per direction over the respective BZB (two threshold values to each BZ on each BZB).

953. Article 16(13) ER states: “When allocating costs of remedial actions between transmission system operators, regulatory authorities shall analyse to what extent flows resulting from transactions internal to bidding zones contribute to the congestion between two bidding zones observed, and allocate the costs based on the contribution to the congestion to the transmission system operators of the bidding zones creating such flows except for costs induced by flows resulting from transactions internal to bidding zones that are below the level that could be expected **without structural congestion in a bidding zone**. That level shall be jointly analysed and defined by all transmission system operators in a capacity calculation region **for each individual bidding zone** border, and shall be subject to the approval of all regulatory authorities in the capacity calculation region.” (emphasis added)
954. First, as has been set out in Sub-Pleas 7.3 and in the Fourteenth Consolidated Plea (Sub-Plea 14.2), given the indispensable nature of the legitimate LF threshold for the RDCTCS (and therefore, given the interaction of all 3 methodologies, also for the RDCT and the ROSC), not setting any threshold at all would have amounted to an infringement of the applicable regulatory framework provided by the CACM and the ER. ACER was under a regulatory obligation to set a legitimate LF threshold in order to carry out its duty of regulatory oversight of All Core TSOs’ RDCTCS Proposal. In so doing, ACER was not in a position to conduct the in-depth LF analysis required by Article 16(13) ER in a month time (from 20 August 2020, when TSOs did not provide requested analysis at the end of the hearing, until the 6-month deadline for ACER to take the RDCTCS decision, which ended on 27 September 2020). Such in-depth LF threshold study per BZ would have required ACER to first determine a situation with no structural congestion in any BZ. This would have required a protracted analysis of, *inter alia*, network investments and alternative BZ configurations which would address and remove all structural congestions in all Core BZs)
955. The Board of Appeal notes that All Core TSOs had not been able to carry out such analysis in a period of nearly 3 years (during the development of All Core TSOs’ RDCTCS Proposal from 17 November 2016 until 27 March 2019 and when requested by ACER to carry out the study from 18 April 2020 until 20 August 2020).
956. ACER’s material impossibility to conduct an in-depth LF threshold study per BZ motivated, therefore, correctly its choice for a Core-level LF threshold in a first step, split between individual BZ in a second step.
957. Second, ACER’s 2-step LF threshold takes account, to the extent possible, of the specific characteristics of both Core CCR and its BZs. The 10%-threshold has been set after a rigorous analysis aimed at reflecting the characteristics of Core BZs (see Sub-Plea 7.2 above). Furthermore, the split of the common threshold between individual Core BZs is done through a splitting method that avoids any discrimination between BZs and allows larger BZs to benefit from the fact that LFs from smaller BZs are not utilising their individual threshold to the full extent. This takes account of the specific characteristics of larger BZs such as the French BZ or the DE-LU BZ (see Sub-Plea 7.9).
958. Third, even though temporary and based on a 2-step approach, ACER complied with the requirement of Article 16(13) ER to determine an individual LF threshold per BZ. In this respect, the Board of Appeal notes that the correct interpretation of Article 16(13) ER is that it requires a LF threshold per BZ and not per BZB. Indeed, cost sharing is not limited to interconnectors. Also, as noted by ACER in its Defence, a LF threshold per BZB would be unviable because “there would be high positive and high negative loop flows which would be netted despite the fact that they would cause high costs”.
- Finally, the 2-step approach of the legitimate LF threshold is consistent with the responsibilities and liabilities of TSOs because it allows Core TSOs precisely to comply with their responsibilities with respect to the RDCTCS under the CACM and the ER, despite their failure to reach an agreement during the decision-making process. The 2-step approach determines the LF threshold in accordance with the requirement of Article 16(13) ER based on the absence of structural congestion. It therefore provides correct incentives to TSOs with

a high level of LFs to takes the necessary measures to reduce the level of LFs below the threshold (e.g. make proper investments within their network, in line with Article 74(6)(a) CACM), in line with their responsibilities and liabilities under Article 75(6)(b) CACM.

7.5 The LF threshold is set at an incorrect value.

959. Most Appellants claim that the value of the threshold set by ACER for legitimate LFs is incorrect for varying reasons.
960. Appellant I²⁰⁵ claims that the legitimate LF threshold set by ACER at 10% should be lowered in order to correctly reflect the PPP in the context of an overestimation of LFs for importing zones and to ensure a correct ratio between the PPP and OPP. Appellant I claims that its opinion is in line with All Core TSOs' Non-Paper, in which Core TSOs indicated a preference for a LF threshold of 5% as the highest value. It alleges an infringement of Articles 74(6)(c) and (i) CACM and 16(13) ER. In its Reply²⁰⁶, Appellant I clarifies that its request is to lower the threshold, without indication to which value.
961. At the Oral Hearing, Appellant I underlined the importance of the threshold. It held that the lower the value of the LF threshold, the lower the share paid by the polluters and the higher the share paid by the owners and, *vice versa*, the higher the value of the LF threshold, the higher the share paid by the polluters and the lower the share paid by the owners. Appellant I added that a low LF threshold supports fair rules of CB trade (as required by the ER) because, in its view, only the PPP supports a fair cost sharing (meaning that costs are borne by those who cause them).
962. Appellant III claims that the 10%-threshold is too low. It ties its claim for a threshold of at least 30% to its claim that the RDCTCS only applies to interconnectors: Article 16(8) ER explicitly allows the use of 30% of its capacity for LFs and reliability margins on interconnectors and no reliability margin needs to be used in the *ex post* process of cost sharing.
963. Appellant IV also claims that the LF threshold should be set in accordance with Article 6(8) ER.
964. Appellant V claims that the common legitimate LF threshold has been arbitrarily set by ACER at 10% and should comply with the 30%-rule of Article 16(8) ER. It alleges that the 10%-threshold lacks a technical justification.
965. Appellant VI claims that the legitimate LF threshold set by ACER is unlawful because it should be based on the maximum limit of Article 16(8) ER.
966. The Board of Appeal notes, with respect to the claim of Appellant III, that the scope of the Contested Decision's RDCTCS is not limited to interconnectors (see First Consolidated Plea).
967. The Board of Appeal also observes, with respect to any discriminatory setting of the LF threshold, that this is dealt with in the Twelfth Consolidated Plea and, with respect to the claims that the LF threshold should be tied to the 30%-split of Article 6(8) ER, that this is dealt with in Sub-plea 7.6 below.
968. The value of 10% is not the result of an arbitrary determination.
969. First, Article 16(13) ER requires that the legitimate LF threshold be determined in the absence of structural congestion. When determining the value of the legitimate LF threshold, the starting point is a situation whereby Core BZs did not experience structural congestion. This starting point unavoidably has an impact on the appropriate value of the threshold.
970. Second, the legitimate LF threshold of 10% relies on factually accurate, reliable and consistent evidence, which is based on the results from the analysis done by All Core TSOs in the context of the Experimentation Report, the results from ACER's own simulations and TSOs' expertise and NRAs' input through the exchanges done during consultations (e.g. All Core TSOs' RDCTCS Non-Paper, All Core NRAs' RDCTCS Non-Paper, consultation by

²⁰⁵ Appeal I, Plea 2, paras 30-34.

²⁰⁶ Appellant I's Reply, para 32.

ACER of All Core NRAs regarding a higher common LF threshold of 15%, etc.). Given that the initiative comes from the market - and in more specifically from All Core TSOs - in the bottom-up RDCTCS decision-making process, ACER had to take account of All Core TSO's Experimentation Report, whilst duly acknowledging its disclaimers and caveats. Moreover, ACER did not rely upon All Core TSOs' Experimentation Report to carry out its assessment of the legitimate LF threshold but carried out its own simulations. ACER's own simulations were based on All Core TSOs' Experimentation Report but included specific parameters aimed at addressing the concerns that All Core NRAs and All Core TSOs had conveyed to ACER during the consultation. When carrying out its own simulations, ACER simulated the results of other scenarios (by modifying the parameters of this same model) in order to (i) carefully evaluate the different arguments from Core TSOs and NRAs and (ii) investigate alternative options that were compliant with Articles 74 CACM and 16 ER.

971. Third, the Board of Appeal observes that the Appellants challenge the value of 10% *per se*. In that respect, it has to be observed that the ultimate aim of penalising LFs above a threshold is in accordance with the PPP is to reduce LFs. Recital (27) ER states: “[...] *Clear minimum levels of available capacity for cross-zonal trade need to be put in place in order to reduce the effects of loop flows and internal congestions on cross-zonal trade and to give a predictable capacity value for market participants*”.
972. The more LFs in the network, the higher the risk of congestion in the BZs hosting these LFs, with all negative consequences for OS.
973. As set out above in the First Consolidated Plea, LFs are unavoidable in a zonal model. That is the reason why Article 16(13) ER requires All Core TSOs to agree on an acceptable level of LFs. And that is the reason why, in the absence of such agreement so far, ACER set a temporary legitimate LF threshold to allow due cost sharing of XRAs in Core CCR. As set out below in the Fourteenth Consolidated Plea, the legitimate LF threshold is indispensable for the correct implementation of the RDCTCS and, consequently, for the correct implementation of the RDCT and the ROSC.
974. Setting the legitimate LF threshold at a very high level would not only jeopardise a correct implementation of the RDCTCS – providing the correct incentives to take all necessary measures to reduce LFs – but also undermine the implementation of the RDCT and the ROSC, threatening OS at Core level.
975. Setting the legitimate LF threshold at a very low level would fail to recognise that a degree of LFs are unavoidable in a zonal model. As correctly set out by Appellant IV in its Reply²⁰⁷, both the limitation of capacity and the inevitability of a certain degree of LFs is inherent to any zonal model and to any trade over large distances in a meshed grid.
976. The Board of Appeal acquiesces the observations of Interveners II to VI, that the effect of increasing the LF threshold is more than linear: BZs that host LFs pay a larger part of the costs to solve congestions and, on top, they will see an increased frequency and volume of congestions. Therefore, every % increase in LF threshold in cost sharing moves the solution more than proportionately away from the PPP.
977. Interveners II to VI provide the following example: “*Drawing a parallel with the capacity calculation process and the 70% requirement of the Article 16(8) of Electricity Regulation, – for demonstration – labelling 15% of the loop flows as acceptable comes to say that only 15% are left for both the reliability margin and the internal flows. Considering a usual value for the reliability margin of 10%, it would imply that only 5% would be left for internal flows. This highlights the fact that any threshold higher than 10% is in fact giving a preference to the loop flows (i.e. they pollute less) over the internal flows. With other words, a 10% threshold means that each country grid tariff payers offer only half of its transmission capacity to host internal exchanges and, offer for free, the second half for loop-flows, for the pollution. The maximum loop flow threshold acceptable is therefore 10% which leads more or less to an equal sharing between loop flows and internal flows.*”
978. Intervener V adds another example: “*Another parallel with the capacity calculation process and the 70% requirement of the Article 16(8) of Electricity Regulation, – for demonstration – labelling 20% of the loop flows as acceptable comes to say that errors in the estimation of loop flow in capacity calculation is covered up to this level by the TSO(s) subject to the congestion. Considering a loop flow level estimated with 5% in capacity*

²⁰⁷ Reply of Appellant IV, para 6.

calculation, the reliability margin being 10%, the capacity offered to the market will be 85%. If in fact the loop flows will finally happen to be 20%, and the market flows 85%, which results in 105% loading of the elements. The polluters' significantly increased contribution is fully covered by the 20% threshold and the TSO(s) subject to the overload shall come up for the costs. This is against the polluter-pays-principle."

979. The Board of Appeal observes that none of Core TSOs tabled the possibility of a 30% legitimate LF threshold during the decision-making process leading up to the Contested Decision. Section 1.9 "Loop flow threshold" of All Core TSOs' RDCTCS Non-Paper²⁰⁸ summarizes the position of All Core TSOs on the appropriate legitimate LF threshold. None of Core TSOs, including the Appellants, tabled a legitimate LF threshold exceeding 15%:

"In accordance with article 16(13) of REGULATION (EU) 2019/943, TSOs have to define the acceptable level of flows resulting from transactions internal to bidding zones. This level of acceptable loop flow is defined by a loop flow threshold.

1.9.1 Core TSO positions

Regarding the loop-flow threshold, the different positions are as follow:

- *9 TSOs support a fix loop-flow threshold for all XBRNEs*
 - o *APG, PSE CEPS, ELES, SEPS, Transelectrica: 5%*
 - o *ELIA, MAVIR: several % up to 10%*
 - o *HOPS: 3%*
- *7 TSOs support a threshold per bidding zone border, but with the different design ideas*
 - o *RTE, TenneT DE, TenneT NL, TransnetBW: LF threshold per XBRNE for each bidding zone border*
 - o *Amprion, 50Hz, CREOS, TransnetBW: LF threshold per direction"*.

980. Fourth, the Board of Appeal notes that the Appellants do not challenge the numerical validity of the simulations performed by ACER which led to the value of 10%. However, it is important to verify the analysis that ACER carried out to reach the 10% LF threshold. Given the fact that none of Core TSOs had mentioned a need for a legitimate LF threshold in excess of 15%, ACER's simulations logically did not cover a threshold in excess of 15%.

981. ACER analysed All Core TSOs' RDCTCS Experimentation Report²⁰⁹, which (i) analysed options based on 3 base scenarios (labelled green/yellow/blue, see [Table 1](#)); (ii) carried out a sensitivity analysis to test cost sharing results against different parameters in each of the scenarios, e.g. the PTFD threshold in relation to XNEs (see [Table 2](#)); and (iii) was limited to 10 timestamps i.e., 10 hours for which the costly and non-costly RAs are optimised within the Core region, which were taken from historical data and were deliberately chosen based on expert knowledge as well as agreed criteria (see [Table 3](#)).

²⁰⁸ Annex 79 to the Defence.

²⁰⁹ All Core TSOs declared in their Explanatory Note on the Core RDCTCS Methodology of February 2019 that "[t]his experimentation cannot support all possible scenarios. Indeed, the multiplicity of the above described options is likely to lead to a number of different scenarios so high that they could not reasonably be computed". The objective of the Core TSOs was to investigate "the different possibilities that can be used to apply the polluter pays principle via the experimentation" and "to explore several ways of applying the methodology, by varying its parameters".

Table 1: Scenarios of All Core TSOs' Experimentation Report.

OPTIONS	GREEN	YELLOW	BLUE
Netting	Equal per category with credit	Equal per category with credit	proportional per category
Internal Flow threshold	Not applicable (no threshold for internal flows)		Y = 30%
Loop Flow threshold (5-10% already agreed in PT)	X = 10%	Common threshold of 20%	X = 0%
Cost allocation Market Flows	Owner of the line	Owner of the line	50:50 source-sink
Cost allocation for LF<x%	Owner of the line	Owner of the line	Causer pays
Order-stack	LF>x% (polluter) Internal flow (owner) LF<x% (owner) Market + PST (owner of the line)	LFs>th (polluter) and IFs (owner) LFs<th (owner) MFs and PST	LF> x% (polluter) IF> y% (owner) Market + PST (same level, polluter) LF < x% (polluter) IF < y% (owner)
Application LF threshold	Equal with credit	Equal with credit	Proportional split / Equal with credit (no NRs Agreement: 2 views)
Non-Core TSO costs	Owner of the line (no socialization)	Owner of the line	Equal share
XB relevance definition	CNECs considered in CCM (with at least 10% PTFD threshold)	Tie line + directly connected line	CNECs considered in CCM with PTFD >= 5%

Source: Experimentation Report, Section 2.2.1 Base scenarios, p.19

Table 2: Sensitivity analysis of All Core TSOs' Experimentation Report.

	Green	Blue 1 (LF th: equal w/ credit)	Blue 2 (LF th: proportional)	Yellow
Scenarios execution	V	V	V	V
Sensitivity analysis XBRNE threshold change vs. results influence	V	V	V	X
Sensitivity analysis LF threshold change vs. results influence	V	V	V	X
Sensitivity analysis IF change vs. results influence	X	V	V	X
Sensitivity analysis IF+LF threshold change vs results influence	X	X	X	V

Source: Experimentation Report, Section 2.2.2 Sensitivity Analysis, p.19

Table 3: Timestamps (10) of All Core TSOs' Experimentation Report.

Timestamp	Label
2018-11-21 06:30	TS1
2018-11-30 10:30	TS2
2019-02-03 23:30	TS3
2019-03-18 19:30	TS4
2019-04-18 16:30	TS5
2019-04-22 15:30	TS6
2019-05-08 08:30	TS7
2019-06-24 09:30	TS8
2019-07-22 13:30	TS9
2019-07-23 16:30	TS10

982.ACER carried out its own simulations of the options on the basis of the arguments that had been put forward by All Core NRAs and All Core TSOs during the consultation phase. The main parameters investigated by ACER in this additional analysis were (i) IF and LF thresholds and (ii) IF and LF priorities in the order-stack, creating 7 additional scenarios (Tables 4, 5 and 6):

Table 4: Additional scenarios of ACER’s own simulation (GREEN, GREEN SENSI 2 and GREEN SENSI 4 scenarios).

Options	Green	Green sensi 2	Green sensi 4
Netting	Equal with credit	Equal with credit	Equal with credit
Internal Flow (IF) threshold (Y)	Y = 0% (no threshold)	Y = 0% (no threshold)	Y = 0% (no threshold)
Core Loop Flow (LF) Threshold (X)	X = 10%	X = 15%	X = 10%
Cost sharing principle (cost allocation) for Allocated Flow (AF)	Owner pays	Owner pays	Owner pays
Cost sharing principle (cost allocation) for Core LF < X	Owner pays	Owner pays	Owner pays
Order-stack	LF > X (Polluter pays); IF (Owner pays); Core LF < X (Owner pays); AF + PST (Owner pays)	LF > X (Polluter pays); IF (Owner pays); Core LF < X (Owner pays); AF + PST (Owner pays);	LF > X (Polluter pays); IF (Owner pays); Core LF < X (Owner pays); AF + PST (Owner pays);
Application Core LF Threshold (common to individual)	Equal splitting with credit	Equal splitting with credit	Equal splitting with credit
Cost sharing principle (cost allocation) for Non-Core LF	Owner pays	Owner pays	Owner pays
Definition of cross-border relevant network element	CNECs considered in the capacity calculation methodology (with a PTDF >= 10%)	CNECs considered in the capacity calculation methodology (with a PTDF >= 10%)	CNECs considered in the capacity calculation methodology (with a PTDF >= 15%)

Source: Paragraph 101 of the Defence, referring to its Annex 24, which includes ACER’s e-mail of 21 July 2020 to All Core NRAs and All Core TSOs and the annexed excelsheet containing “Scenarios ACER.

Table 5: Additional scenarios of ACER’s own simulation (ACER SCEN.1, ACER SCEN.2 and ACER SCEN.3 scenarios).

Options	ACER Scen. 1	ACER Scen. 2	ACER Scen. 3
Netting	No netting	No netting	No netting
Internal Flow (IF) threshold (Y)	X+Y = 20% (after deduction of non-Core LFs, min X+Y = 10%)	X+Y = 20% (after deduction of non-Core LFs, min X+Y = 10%)	X+Y = 20% (after deduction of non-Core LFs, min X+Y = 10%)
Core Loop Flow (LF) Threshold (X)	X+Y = 20% (after deduction of non-Core LFs, min X+Y = 10%)	X+Y = 20% (after deduction of non-Core LFs, min X+Y = 10%)	X+Y = 20% (after deduction of non-Core LFs, min X+Y = 10%)
Cost sharing principle (cost allocation) for Allocated Flow (AF)	Owner pays	Owner pays	Owner pays
Cost sharing principle (cost allocation) for Core LF < X	Owner pays	Owner pays	Owner pays
Order-stack	LF > X (Polluter pays); IF > Y (Owner pays); LF < X (Owner pays); IF < Y (Owner pays); AF (Owner pays); PST (Owner pays)	LF, IF > Ind. Thr. (Polluter pays; Owner pays); LF, IF < Ind. Thr. (Owner pays); AF (Owner pays); PST (Owner pays)	LF, 50%IF > Ind. Thr. (Polluter pays; Owner pays); LF, 50%IF < Ind. Thr. (Owner pays); AF (Owner pays); PST (Owner pays)
Application Core LF Threshold (common to individual)	Equal splitting with credit	Equal splitting with credit	Equal splitting with credit
Cost sharing principle (cost allocation) for Non-Core LF	Owner pays	Owner pays	Owner pays
Definition of cross-border relevant network element	All XNEs	All XNEs	All XNEs

Source: Paragraph 101 of the Defence, referring to its Annex 24, which includes ACER's e-mail of 21 July 2020 to All Core NRAs and All Core TSOs and the annexed excelsheet containing "Scenarios ACER."

Table 6: Additional scenarios of ACER's own simulation (ACER SCEN.4, ACER SCEN.5, ACER SCEN.6 and ACER SCEN.7 scenarios).

Options	ACER Scen. 4	ACER Scen. 5	ACER Scen. 6	ACER Scen. 7
Netting	No netting	No netting	No netting	No netting
Internal Flow (IF) threshold (Y)	Y = 0% (no threshold)	Y = 0% (no threshold)	Y = 0% (no threshold)	Y = 0% (no threshold)
Core Loop Flow (LF) Threshold (X)	X = 10%	X = 10%	X = 10%	X = 15%
Cost sharing principle (cost allocation) for Allocated Flow (AF)	Owner pays	Owner pays	Owner pays	Owner pays
Cost sharing principle (cost allocation) for Core LF < X	Owner pays	Owner pays	Owner pays	Owner pays
Order-stack	LF > X (Polluter pays); IF > Y (Owner pays); LF < X (Owner pays); IF < Y (Owner pays); AF (Owner pays); PST (Owner pays)	LF, IF > Ind. Thr. (Polluter pays; Owner pays); LF, IF < Ind. Thr. (Owner pays); AF (Owner pays); PST (Owner pays)	LF, 50%IF > Ind. Thr. (Polluter pays; Owner pays); LF, 50%IF < Ind. Thr. (Owner pays); AF (Owner pays); PST (Owner pays)	LF, 25%IF > Ind. Thr. (Polluter pays; Owner pays); LF, 25%IF < Ind. Thr. (Owner pays); AF (Owner pays); PST (Owner pays)
Application Core LF Threshold (common to individual)	Equal splitting with credit	Equal splitting with credit	Equal splitting with credit	Equal splitting with credit
Cost sharing principle (cost allocation) for Non-Core LF	Owner pays	Owner pays	Owner pays	Owner pays
Definition of cross-border relevant network element	All XNEs	All XNEs	All XNEs	All XNEs

Source: Paragraph 101 of the Defence, referring to its Annex 24, which includes ACER's e-mail of 21 July 2020 to All Core NRAs and All Core TSOs and the annexed excelsheet containing "Scenarios ACER."

983. ACER discussed the results of its own simulations during consultation to allow All Core TSOs and All Core NRAs to consider the concrete impact of these choices and options, as set out in paragraph 24 of the Contested Decision: "During the close cooperation phase between ACER and all Core regulatory authorities and TSOs as detailed in paragraph (11) above, and beyond the above-mentioned issues, ACER: (...) (e) provided simulation results for all the choices and options which were discussed during consultation to allow the TSOs and regulatory authorities to consider the concrete impact of these choices and options; (...)". ACER's Defence summarises the results of ACER's own simulations of July 2020 including 3 base scenarios and 2 sensitivity analysis for the green scenarios (i.e. the scenario "GREEN_SENSI_2" where the LF threshold was increased from 10% to 15% and (ii) the scenario "GREEN_SENSI_4" where the PTDF threshold was increased from 10% to 15%), as shown in Table 7.

Table 7: Cost shares (in %) for coordinated RAs taken during 10 timestamps of All Core TSOs' RDCTCS Experimentation Report in various scenarios of ACER's simulations.

Scenario (%)	AT	BE	CZ	DE	FR	HR	HU	NL	PL	RO	SI	SK	TOTAL
GREEN	21,2%	0,3%	1,2%	68,9%	8,1%	-0,5%	0,0%	0,0%	0,9%	0,0%	-0,2%	0,2%	100,0%
GREEN_SENSI_2	21,1%	0,4%	1,2%	69,8%	7,0%	-0,6%	0,1%	0,1%	1,0%	0,0%	-0,3%	0,2%	100,0%
GREEN_SENSI_4	21,1%	0,3%	1,2%	66,7%	8,1%	-0,5%	0,0%	2,9%	0,3%	0,0%	-0,2%	0,2%	100,0%
YELLOW	21,5%	0,5%	-2,4%	57,9%	5,6%	-0,7%	0,2%	6,0%	11,2%	0,0%	-0,2%	0,4%	100,0%
BLUE	14,7%	1,4%	1,2%	56,5%	11,6%	1,3%	2,5%	3,6%	2,5%	1,2%	1,4%	2,0%	100,0%
ACER Scen. 1	22,6%	0,4%	1,2%	67,8%	6,5%	-0,5%	0,0%	0,9%	1,1%	0,0%	-0,2%	0,1%	100,0%
ACER Scen. 2	22,6%	0,4%	0,6%	64,3%	6,5%	-0,5%	0,0%	3,4%	2,7%	0,0%	-0,2%	0,1%	100,0%
ACER Scen. 3	22,6%	0,4%	0,8%	65,6%	6,5%	-0,5%	0,0%	2,6%	1,9%	0,0%	-0,2%	0,1%	100,0%
ACER Scen. 4	19,8%	0,5%	1,0%	69,5%	7,6%	-0,4%	0,0%	0,9%	1,0%	-0,1%	-0,1%	0,5%	100,0%
ACER Scen. 5	19,6%	0,5%	0,4%	65,3%	7,6%	-0,4%	0,0%	3,7%	3,0%	-0,1%	-0,1%	0,4%	100,0%
ACER Scen. 6	19,7%	0,5%	0,6%	66,7%	7,6%	-0,4%	0,0%	2,9%	2,1%	-0,1%	-0,1%	0,5%	100,0%
ACER Scen. 7	21,3%	0,4%	1,0%	66,4%	7,7%	-0,5%	0,0%	2,1%	1,6%	0,0%	-0,1%	0,2%	100,0%
Average	20,6%	0,5%	0,7%	65,4%	7,5%	-0,4%	0,2%	2,4%	2,5%	0,1%	-0,1%	0,4%	100,0%
Minimum	14,7%	0,3%	-2,4%	56,5%	5,6%	-0,7%	0,0%	0,0%	0,3%	-0,1%	-0,3%	0,1%	100,0%
Maximum	22,6%	1,4%	1,2%	69,8%	11,6%	1,3%	2,5%	6,0%	11,2%	1,2%	1,4%	2,0%	100,0%

Source: Paragraph 102 and 501 of the Defence, referring to its Annexes 24 and 87.

984. The parameters of ACER SCEN.4, highlighted in grey and underlined in bold in Table 7 correspond to the parameters of the Contested Decision if mapping solution iVBM had been adopted (however, the Contested Decision did not adopt mapping solution iVBM but mapping solution LCBM). There was no scenario with a LF threshold >15% in none of the sensitivity analysis of All Core TSOs' RDCTCS Experimentation Report.
985. The Board of Appeal analyses the results of the ACER SCEN.4 scenario (a LF threshold of 10%, no IF threshold, no common IF/LF threshold and no IF priority) for the Member States of the Appellants: the shares in total costs of Germany was 69.5%, France 7.6% and Poland 1%.
986. Under the GREEN scenario (a LF threshold of 10%, no IF threshold, no common IF/LF threshold and a PTDF threshold of 10% for XNE), the shares in total costs of Germany was 68.9%, France 8.1% and Poland 0.9%.
987. Under the GREEN SENS₂ scenario (a LF threshold of 15%, no IF threshold, no common IF/LF threshold and a PTDF threshold of 10% for XNE), the shares in total costs of Germany was 69.9%, France 7% and Poland 1%.
988. Under the ACER SCEN.7 scenario (a LF threshold of 15%, no IF threshold, no common IF/LF threshold and a prioritisation of 25% of the IFs), the shares in total costs of Germany was 66.4%, France 7.7% and Poland 1.6%.
989. In August 2020, ACER performed new simulations for ACER SCEN.4 scenario, whereby the only difference was a different mapping solution (LCBM), as shown below in Table 8.

Table 8: Cost shares (in %) for coordinated RAs taken during 10 timestamps of All Core TSOs' RDCTCS Experimentation Report under ACER scenario 4, comparing iVBM mapping and LCBM mapping.

Mapping	AT	BE	CZ	DE	FR	HR	HU	NL	PL	RO	SI	SK	Sum
iVBM old	19.8%	0.5%	1.0%	69.5%	7.6%	-0.4%	0.0%	0.9%	1.0%	-0.1%	-0.1%	0.5%	100.0%
LCBM	11.9%	0.3%	17.1%	60.4%	1.8%	0.2%	0.0%	3.5%	4.3%	0.0%	0.0%	0.6%	100.0%

Source: Paragraphs 103 and 504 of the Defence, referring to its Annexes 28 and 87.

990. In March 2021, after the Appeals had been submitted by the Appellants, ACER carried out an additional analysis to simulate the influence of the variation of the LF threshold and of the IF prioritisation % under the LCBM mapping of the Contested Decision because such variations had not yet been simulated²¹⁰. The results are shown in Table 9, which adds an additional line to ACER's simulations of August 2020:

Table 9: Cost shares (in %) for coordinated RAs taken during 10 timestamps of All Core TSOs' RDCTCS Experimentation Report under ACER scenario 4, comparing (1) August 2020 simulations with iVBM mapping; (2) August 2020 simulations with LCBM mapping and (3) March 2021 simulation with LCBM mapping.

	Mapping (cost shares %)	AT	BE	CZ	DE	FR	HR	HU	NL	PL	RO	SI	SK	Sum
1	ACER SC4. iVBM old August 2020	19.8%	0.5%	1.0%	69.5%	7.6%	-0.4%	0.0%	0.9%	1.0%	-0.1%	-0.1%	0.5%	100.0%
2	ACER SC4. LCBM August 2020	11.9%	0.3%	17.1%	60.4%	1.8%	0.2%	0.0%	3.5%	4.3%	0.0%	0.0%	0.6%	100.0%
3	ACER SC4. LCBM March 2021	10.8%	0.1%	14.9%	61.5%	2.0%	0.3%	0.0%	7.2%	3.1%	0.0%	0.0%	0.2%	100.0%

Source: Paragraphs 505 and 506 of the Defence, referring to its Annexes 28, 86 and 87.

²¹⁰ As confirmed in ACER's reply to the Board of Appeal's Third Request for Information, the simulations of March 2021 were done on the basis of the inputs used in ACER's simulation of August 2020 following the correction of a clerical error. This is set out in para 505 and footnotes 291 and 548 of the Defence and in Annex 99 to ACER's Rejoinder.

991. The Board of Appeal notes that the results of the simulations, evidenced by ACER in its Defence²¹¹ show that the value of 10% of the temporary Core LF threshold to be divided per Core BZ is appropriate:

- an increase of the LF threshold from 10% to 15% implies (i) an increase of Germany's cost share²¹², (ii) a negligible decrease of France's cost share, and (iii) no impact on Poland's cost share.
- a decrease of the LF threshold from 10% to 5% implies (i) a decrease of Germany's cost share, (ii) an increase of France's cost share, and (iii) a negligible decrease of Poland's cost share. The results of the simulations clearly demonstrate that ACER set an appropriate LF threshold, given all the BZs involved and their respective network particularities.

992. The conclusion from the simulations performed by ACER is that the impact in terms of cost sharing between the different scenarios that ACER analysed is not very high and that the contribution of Germany, France and Poland is quite constant regardless of the varying parameters.

993. In light of the above, the Board of Appeal concludes that the value of the 10% LF threshold set by ACER in the Contested Decision is not unlawful.

7.6 The LF threshold should not be fixed but floating and infringes Article 16(8) ER.

994. Appellants III and IV allege that Article 16(8) ER foresees that a percentage of 30% can be used freely for reliability margins, LFs and IFs, whilst 70% has to be made available for CB trade. Hence, the common threshold for acceptable LFs should, in their opinion, not be fixed but floating, at least until All Core TSOs perform a study to determine the acceptable LF threshold.

995. Appellant III claims that Article 16(8) ER does not contain a further distinction between the different sub-categories of non-CZ trade (reliability margins reflecting exchange uncertainties, LFs, IFs) but only states that up to 30% of the maximum interconnection capacity is freely available to the TSOs and can be used for non-CZ trade flows without any further specification. In Appellant III's view, TSOs may use up to the maximum of 30% of the interconnection capacity for LFs.

996. Appellant III notes that, in particular, on interconnectors, there are no IFs and that therefore the 30% is to be used for LFs and reliability margins (which can be argued not to apply after the actual flow has taken place, *ex post*, during cost sharing).

997. Appellant III adds furthermore that a fixed threshold is inconsistent with Article 10(5) Core CCM, which foresees that a percentage of 30% of the technical capacity of a relevant network can be used freely for reliability margins, LFs and IFs, mirroring Article 16(8) ER. The common LF threshold of 10% threatens to create inconsistencies with Core CCM, hindering a smooth execution of the CC process.

998. Appellant V claims that the 30%-threshold of Article 16(8) ER constitutes an upper bound of the individual thresholds to be determined according to Article 16(13) ER. This implies that for CNECs, the individual thresholds may not exceed 30% of its maximum capacity. Appellant V alleges that a 10%-threshold instead of 30%-threshold penalises TSOs because, in an extreme scenario, TSOs will have to provide 90% of the CZC for market flows (instead of 70%) in order to avoid having to solely bear the costs related to LFs. This goes, in its opinion, against the will of the European legislator, who considered the use of interconnection capacity of up to 30% for LFs to be legitimate. Appellant V adduces that under the Contested Decision's RDCTCS, Core TSOs "are forced to use less than 30% for loop flows via the "detour" of

²¹¹ Defence, paras 505-506, supported by Annex 86 to the Defence containing the sheet "Sum 1-10" of the Excel file "Appeal_RDCS_ACER_SUMMARY ALL TS 01-10 Ver2S_DDW" and Annexes 29 to 38 containing the underlying data used for Annex 86.

²¹² The Board of Appeal had verified that ACER's simulation results are more favourable for Germany and contradict the forecasts and claims of Appellants III, IV and V.

cost-sharing. If they use more than 10% of the capacity on an eligible network element for loop flows, they are “penalised” by having to solely bear the costs caused by these loop flows.” This implies, in Appellant V’s opinion, that the 10%-threshold indirectly penalises flows that the ER explicitly considered permissible.

999. Appellant V alleges that Recital (28) ER states that the objective of the minimum capacity is to reduce “uncoordinated curtailments of interconnector capacities”, i.e. to reduce LFs and internal congestions on CZ trade. If the minimum capacity is made available it is irrefutably presumed that TSOs do not limit the volume of the interconnection capacity to be made available to market participants as a means of solving congestion within their own BZ or as a means of managing flow resulting from transactions internal to BZs.
1000. Appellant VI claims that the legitimate LF threshold set by ACER is unlawful because it should be based on the maximum limit of Article 16(8) ER.
1001. Article 16(8) ER reads as follows: “Transmission system operators shall not limit the volume of interconnection capacity to be made available to market participants as a means of solving congestion inside their own bidding zone or as a means of managing flows resulting from transactions internal to bidding zones. Without prejudice to the application of the derogations under paragraphs 3 and 9 of this Article and to the application of Article 15(2), this paragraph shall be considered to be complied with where the following minimum levels of available capacity for cross-zonal trade are reached: (a) for borders using a coordinated net transmission capacity approach, the minimum capacity shall be 70 % of the transmission capacity respecting operational security limits after deduction of contingencies, as determined in accordance with the capacity allocation and congestion management guideline adopted on the basis of Article 18(5) of Regulation (EC) No 714/2009; (b) for borders using a flow-based approach, the minimum capacity shall be a margin set in the capacity calculation process as available for flows induced by cross-zonal exchange. The margin shall be 70 % of the capacity respecting operational security limits of internal and cross-zonal critical network elements, taking into account contingencies, as determined in accordance with the capacity allocation and congestion management guideline adopted on the basis of Article 18(5) of Regulation (EC) No 714/2009. The total amount of 30 % can be used for the reliability margins, loop flows and internal flows on each critical network element.”
1002. The Board of Appeal notes, with respect to the claim of Appellant III, that the scope of the Contested Decision’s RDCTCS is not limited to interconnectors (see First Consolidated Plea).
1003. The Board of Appeal also refers to the First Consolidated Plea, Sub-Pleas 1.1.2, 1.3 and 1.7, with respect to the relationship between the CC process and the RDCTCS.
1004. First, the RDCTCS relates to XRAs, which are CM measures, whereas Article 16 ER contains the “*general principles of capacity allocation and congestion management*”, i.e. it covers a wider scope of CACM, i.e. CM and CA. Regardless of the fact that the ER has been adopted after the CACM, the Contested Decision’s RDCTCS needs to comply with the ER to the extent that they are CM principles, because RDCT are CM measures and not CA measures. Yet the general principles of Article 16 ER contain both CA and CM measures.
1005. Second, the LF threshold complies with the general principles of CM contained in Article 16 ER, especially Articles 16(1) and 16(13) ER. As is set out in Fourteenth Consolidated Plea, ACER was under a regulatory obligation to set the LF threshold in order to ensure compliance with Article 16(13) ER and with its mandate to adopt the RDCTCS decision in accordance with the CACM overall. As set out in the Twelfth Consolidated Plea, the LF threshold does not violate the principle of non-discrimination.
1006. Third, Article 16(8) ER contains a general principle of CA (maximising interconnection capacity or CZC up to 70% and maintaining 30% for IFs, LFs and the reliability margin). This principle applies to the CC processes but not to the cost sharing process of the RDCTCS. Both processes are different and serve different goals at different points in time, as set out in the First Consolidated Plea. CC processes do not execute costly RAs and, therefore, no costs arise from them. If the 30%-threshold were to amount to the applicable threshold for LFs, there would be no need for Article 16(13) ER to require such threshold, and even less to require TSOs to perform an in-depth study to set the threshold per BZ.
1007. Fourth, the 30% reserved for IFs, LFs and reliability margin is not a threshold but a cap. Article 16(8) ER codified the cap that had been set by ACER in ACER Decision 02/2019 (Article 10(5) of the DA CCM and Article 10(5) of the ID CCM). In ACER Decision

02/2019, ACER decided to cap IFs, LFs and reliability margin to a maximum of 30% of allowable flows on CNECs. This consequently required that at least 70% of maximal allowable flows on CNECs be reserved for CZ exchanges²¹³. The 70% is a *de minimis* requirement and TSOs have the obligation to maximise trade beyond 70% if they can, without applying costly RAs²¹⁴. ACER reached the conservative figure of 70% through a benchmarking exercise on limited data made available by the CWE and Nordic TSOs, which did not take account of XRA-related cost sharing process. Given its nature of a cap, the 30%-reserve for IFs, LFs and reliability margin is, as Appellants correctly indicate, floating: if CZ exchanges take-up 85%, there will only be 15% left for IFs, LFs and reliability margin. The 10%-threshold is, due to the fact that it is a threshold, not flexible: LFs above the threshold are not considered legitimate whereas LFs below the threshold are considered legitimate. The wording of Article 16(13) ER is clear in that it requires a threshold and not a cap.

1008. Fifth, the 30%-capacity for IFs, LFs and reliability margin is not in any way affected by the 10%-threshold for legitimate LFs.

7.7 The LF threshold infringes Article 15(2) ER.

1009. Appellant V claims that the 10%-threshold of the Contested Decision's RDCTCS undermines Article 15(2) ER, which allows TSOs to reach the minimum capacity of 70% by a gradual linear trajectory in 2025 if a Member State established an AP in the sense of Article 15(3) ER. Article 15(2) ER grants the possibility that non-CZ trade flows (i.e. primarily LFs) may even exceed 30% of the interconnection capacity in the transitional phase of an AP. Appellant V alleges that the same applies to temporary derogations from the minimum capacity (Article 16(9) ER).
1010. Articles 15(2) and 16(9) ER allow for exceptions to the 70% minimum capacity rule of Article 16(8) ER. The Board of Appeal refers to Sub-Plea 6.7, which sets out that the rule of Article 16(8) ER does not determine any legitimate LF threshold. Consequently, the minimum capacity rule of Article 16(8) ER - and its exceptions - continues to apply to CC processes, in parallel with RA cost sharing processes, where a temporary legitimate 10% LF threshold will allow costs to be allocated to TSOs causing LFs above the threshold in line with the PPP.

7.8 The LF threshold infringes Article 74(6)(b) CACM with Article 16(8) and (13) ER.

1011. Appellant II claims that Article 74(6)(b) CACM requires an individual threshold per BZ to be consistent with the responsibilities and liabilities of Core TSOs.
1012. Appellant IV claims that, given that Article 74(6)(b) CACM requires the RDCTCS to be consistent with the responsibilities and liabilities of the TSOs involved and that Article 16(13) ER foresees that it is All Core TSOs' responsibility to jointly analyse and determine a legitimate LF threshold, ACER's determination of a common LF threshold infringes both provisions.
1013. Appellant IV also claims that these responsibilities and liabilities involve compliance with Article 16(8) ER, which provides that the total amount of 30% of the capacity can be used by the TSOs for the reliability margin (which is generally irrelevant in the context of cost sharing given that costs are determined *ex post* whereas the reliability margin is determined *ex ante* as a means of operating the system in a secure manner), LFs and IFs on each CNE. Appellant IV argues that, by setting a common LF threshold at 10%, All Core TSOs' responsibility to use up to 30% of the capacity for LFs is violated.
1014. Appellant IV claims that the legitimate LF threshold is not an indispensable part of the RDCTCS and that, in the absence of a determination of a legitimate LF threshold by All Core TSOs pursuant to Article 16(13) ER, Article 16(8) ER provided a mandatory temporary solution, i.e. a legitimate LF threshold of 30% for each eligible NE, allowing for a flexible use

²¹³ ACER Decision 02/2019, para 124. Board of Appeal Decision A-001-2019, para 100.

²¹⁴ Board of Appeal Decision A-001-2019, para 115.

of the total 30% for TSOs to react adequately to individual LFs (as opposed to a common threshold for all eligible NEs).

1015. The Board of Appeal finds that the setting of a temporary legitimate LF threshold is consistent with the responsibilities and liabilities of TSOs under Article 74(6)(b) CACM because it allows Core TSOs precisely to comply with their responsibilities with respect to the RDCTCS under the CACM and the ER, despite their failure to reach an agreement during the decision-making process. The LF threshold of the Contested Decision's RDCTCS takes account of the absence of structural congestion in accordance with Article 16(13) ER. It therefore provides correct incentives to TSOs with a high level of LFs to take the necessary measures to reduce the level of LFs below the threshold (e.g. make proper investments within their network, in line with Article 74(6)(a) CACM), in line with their responsibilities and liabilities under Article 75(6)(b) CACM.
1016. As has been set out in Sub-Pleas 7.3 and in the Fourteenth Consolidated Plea (Sub-Plea 14.2), given the indispensable nature of the legitimate LF threshold for the RDCTCS (and therefore, given the interaction of all 3 methodologies, also for the RDCT and the ROSC), not setting any threshold at all would have amounted to an infringement of the applicable regulatory framework provided by the CACM and the ER, especially Article 16(13) ER. ACER was under a regulatory obligation to set a legitimate LF threshold in order to carry out its duty of regulatory oversight of All Core TSOs' RDCTCS Proposal.
1017. The responsibilities and liabilities of TSOs do not have to be considered in a vacuum but correctly placed in the large picture of the EU bottom-up decision-making processes to achieve integration of the electricity markets at EU-level. These decision-making processes are market-driven, bottom-up, gradual, step-based, multipartite processes in which, at different points in time, various national and EU stakeholders – in essence the TSOs, NRAs and ACER – are required to take formal steps to attain certain goals set by EU law. These multipartite bottom-up decision-making processes ensure that the initiative comes from the market but that, given the private interests of the market players taking the initiative (TSOs), the initiative is supervised by regulatory authorities as to their compliance with EU regulation (NRAs and/or ACER). These processes guarantee multipart balances between a variety of national and EU stakeholders, with ample possibilities for them to consult and interact²¹⁵.
1018. In this bottom-up decision-making process, the TSOs' role is to develop proposals and submit them for regulatory approval to the regulators, i.e. the NRAs (or ACER in the event of a disagreement of the NRAs beyond a certain deadline or in case of a joint referral by the NRAs). It is noteworthy that this has changed since: now, under the revised regime of regulators' competences of Article 5 of the ACER Regulation, All TSOs' proposals are not submitted for approval to All NRAs anymore but to ACER. In this bottom-up decision-making process, the role of the regulators – either the NRAs or ACER – is to assess whether the TSOs' proposals comply with the applicable regulatory framework in order to subsequently grant regulatory approval.
1019. The powers conferred upon ACER by EU law are to supervise All Core TSOs' initiative to ensure compliance with the EU regulatory framework. In so doing, in accordance with Article 74(6)(b) CACM, ACER had to ensure that the RDCTCS would be consistent with the responsibilities and liabilities of All Core TSOs, *inter alia*, Article 16(13) ER, which requires a legitimate LF threshold.
1020. Given that All Core TSOs' RDCTCS Proposal did not contain a legitimate LF threshold as required by Article 16(13) ER, ACER had to ensure compliance with Article 16(13) ER as per Article 74(6)(f) CACM. It therefore asked All Core TSOs to set the legitimate LF threshold

²¹⁵ Board of Appeal Decisions A-004-2019, para 233; A-001-2020, paras 14, 102, 106, 138, 139, 160, 161, 184, 188, 234 and 258; A-002-2020, paras 14, 102, 106, 139, 140, 161, 162, 185, 189, 235 and 259; A-003-2020, para 14; A-007-2020, paras 5, 14, 68, 103 and 104; and A-008-2020, paras 19, 113-115, 138, 150, 153, 165, 167, 175, 188, 218, 239, 250, 290, 297 and 326.

required by Article 16(13) ER in a 4 month deadline but, in the absence of compliance by All Core TSOs, it was under a duty to ensure compliance with Article 16(13) ER and therefore determined a temporary common threshold for legitimate LFs in the amount of 10%, following a rigorous analysis of the results from All Core TSOs' Experimentation Report, All Core TSOs' Non-Paper, All Core NRAs' Non-Paper and the results from ACER's own simulations using a variety of parameters. The Contested Decision's RDCTCS clarifies that this threshold is temporary and will automatically be replaced by a new threshold commonly determined by All Core TSOs and approved by All Core NRAs. The Board of Appeal notes that no steps have been taken by Core TSOs to determine a legitimate LF threshold since the adoption of the Contested Decision²¹⁶.

1021. The Board of Appeal refers to Sub-Plea 7.6 above regarding compliance with Article 16(8) ER.

7.9 The LF threshold should not be equally split among BZs.

1022. Appellant IV alleges that the equal splitting denies the possibility for TSOs to make a flexible use of the 30% of the capacity and that a proportional splitting should have been set. Appellant IV disagrees with ACER's reasoning that a proportional splitting would lead to make the smallest BZs without structural congestion still pay a portion of the costs of RAs, contrary to Article 16(13) ER because, in Appellant IV's opinion, the EU legislator's intention was not to create small BZs as a means to avoid an undue amount of LFs, but to create BZs without LT structural congestion, unless they have no impact on neighbouring BZs or, as a temporary exemption, their impact on neighbouring BZs is mitigated through the use of RAs and those structural congestions do not lead to reductions of CZC in accordance with Article 16 ER (Article 14 ER). It also invokes Article 15(2) ER to set out that Core TSOs of large BZs are given time to tackle their alleged structural congestions by means of linear trajectory or APs.
1023. Appellant IV claims that equal splitting infringes Article 74(6)(c) CACM, which requires the RDCTCS to ensure a fair distribution of costs and benefits between the TSOs involved. In Appellant IV's view, it is fair to penalise LF polluters but it is not fair to over-penalise LF polluters and the Contested Decision's RDCTCS over-penalises Core TSOs of large BZs and ultimately those TSOs' end-customers refinancing the costs via network fees or tariffs. Appellant IV refers to the example provided by ACER in paragraph 119 of the Contested Decision.
1024. Appellant IV also claims that equal splitting infringes Article 74(6)(f) CACM, which requires the RDCTCS to facilitate adherence to the general principles of CM as set out in Article 16(13) ER. In its view, ACER errs in considering that Article 16(13) ER aims at protecting smaller BZs and in considering that proportional splitting renders the concept of a threshold superfluous.
1025. Appellant IV also claims that equal splitting is contrary to the PPP of Article 16(13) ER since polluters of smaller BZs will not bear any costs despite their contribution to a congestion (possibly along with the polluters of larger BZs).
1026. Finally, Appellant IV opposes equal splitting because it only mitigates the over-penalisation of LFs to a marginal extent for large BZs. In its opinion, the intention of Article 16(13) ER is not to grant privileges to small BZs at the expense of larger BZs (and ultimately, their end-consumers) but that TSOs only bear the costs of illegitimate LFs in the absence of structural congestion (ideal grid topology and/or ideal BZ configuration). In other words, the absence of structural congestion is the only factor conditioning the threshold. This has been accepted by All Core NRAs (paragraph 23(c) of the Contested Decision).
1027. Intervener I observes that the second step of the splitting method of the Contested Decision's RDCTCS does not alleviate the fact that the threshold is not set per BZ but amplifies it.

²¹⁶ Replies to the Third Request for Information of the Board of Appeal of Appellants I, III, IV, V and VI.

1028. The Contested Decision (paragraphs 118 to 120) explains why, in the second step of the 2-step threshold, the common threshold is split equally among all Core BZs that create LFs on the concerned NE.
1029. The splitting method of the Contested Decision's RDCTCS splits the common LF threshold equally between BZs and provides that, if Core BZs have a level of LFs below the equally divided individual BZ LF threshold (negative value), this negative leftover value of usable but unused LFs can be redistributed to relieve Core BZs having a level of LFs above the threshold. Thus, the individual BZ LF threshold of the relieved Core BZs is increased proportionally to the unused leftovers of structurally not congested BZs. Ultimately the sum of all LFs from all Core BZs below the individual threshold is equal to the common LF threshold of 10%. As set out in the Contested Decision (paragraph 117), the aim is that BZs with a high level of LFs benefit from the fact that BZs with a low level of LFs are not utilising their individual threshold to the full extent. In so doing, the Contested Decision's RDCTCS aims at alleviating any disproportionate burden for larger BZs, e.g. the French BZ or the DE-LU BZ.
1030. The Board of Appeal has duly analysed the illustrations of the splitting method of the Contested Decision's RDCTCS and the proportional splitting method respectively included in Table 1 and Table 2 of paragraph 119 of the Contested Decision.
1031. They have the same starting point. The total LFs are 20% and there are 5 BZs, which generate LFs on top of the Fmax of a XNE in varying %:

- BZ 1 creates 1% LFs on top of Fmax => it represents 1% of the total LFs of 20% = 5%
- BZ 2 creates 3% LFs on top of Fmax => it represents 3% of the total LFs of 20% = 15%
- BZ 3 creates 8% LFs on top of Fmax => it represents 8% of the total LFs of 20% = 40%
- BZ 4 creates 2% LFs on top of Fmax => it represents 2% of the total LFs of 20% = 10%
- BZ 5 creates 6% LFs on top of Fmax => it represents 6% of the total LFs of 20% = 30%

The Contested Decision's RDCTCS splitting method.

First, the 10% LF-threshold is equally split among each of the 5 BZs:
 $10\%/5 = 2\%$ for each BZ.

Then, splitting is adjusted to take account of the absence of structural congestion:

- BZ 1 only generates 1% LFs: below its 2% LF threshold => 1% leftover, contributes 0%
- BZ 2 generates 3% LFs: 1% above its 2% LF threshold => no leftover, contributes 1%
- BZ 3 generates 8% LFs: 6% above its 2% LF threshold => no leftover, contributes 6%
- BZ 4 only generates 2% LFs: equal to the 2% LF threshold => no leftover, contributes 0%
- BZ 5 generates 6% LFs: 4% above its 2% LF threshold => no leftover, contribute 4%

The leftover created by BZ 1 (1% leftover or negative value) is redistributed to the BZs with LFs above the threshold, i.e. BZ 2, BZ 3 and BZ 5 ($1\%/3 = 0.33\%$), turning the 2% into 2.33% for these BZs. Hence, BZ 2, BZ3 and BZ 5 will benefit from the redistribution as follows:

- BZ 2 generates 3% LFs: 0.67% above its 2.33% LF threshold
- BZ 3 generates 8% LFs: 6% above its 2.33% LF threshold
- BZ 5 generates 6% LFs: 4% above its 2.33% LF threshold

BZ	LF %	Contribution to LF costs <u>without a threshold</u>	BZ LF threshold after equal splitting	LFs Left-Over (non-used %)	LFs above BZ LF %	BZ LF threshold adjusted to structural congestion	LFs above adjusted BZ LF threshold	Contribution to LF costs <u>after splitting of Contested Decision</u>
BZ 1	1%	5%	2%	-1%	0%	/	0%	0%
BZ 2	3%	15%	2%	/	1%	2.33%	0.67%	6.7%
BZ 3	8%	40%	2%	/	6%	2.33%	5.67%	56.6%
BZ 4	2%	10%	2%	/	0%	/	0%	0%
BZ 5	6%	30%	2%	/	4%	2.33%	3.67%	36.7%
ALL		TOTAL	TOTAL	TOTAL			TOTAL	TOTAL

BZs	20%	LF contribution 100%	LF threshold 10%	LF threshold 10%		LF threshold 10%	LF contribution 100%
-----	-----	-----------------------------	------------------	-------------------------	--	------------------	-----------------------------

Source: Board of Appeal, based on the example of paragraph 119 of the Contested Decision

Proportional splitting

The 10% LF-threshold is proportionally split among each of the 5 BZs:

- BZ 1: 5% of the total 10% LF threshold: **0.5%**
- BZ 2: 15% of the total 10% LF threshold: **1.5%**
- BZ 3: 40% of the total 10% LF threshold: **4%**
- BZ 4: 10% of the total 10% LF threshold: **1%**
- BZ 5: 30% of the total 10% LF threshold: **3%**

BZ	LF %	Contribution to LF costs <u>without a threshold</u>	BZ LF threshold <u>after proportional splitting</u>	Contribution to LF costs <u>after proportional splitting</u>
BZ 1	1%	5%	0.5%	5%
BZ 2	3%	15%	1.5%	15%
BZ 3	8%	40%	4%	40%
BZ 4	2%	10%	1%	10%
BZ 5	6%	30%	3%	30%
ALL BZs	20%	TOTAL LF contribution 100%	TOTAL LF threshold 10%	TOTAL LF contribution 100%

Source: Board of Appeal, based on paragraph 119 of the Contested Decision

Comparison of the splitting method of the Contested Decision’s RDCTCS and proportional splitting.

BZ	LF %	Contribution to LF costs <u>without a threshold</u>	Contribution to LF costs <u>after splitting of Contested Decision</u>	Contribution to LF costs <u>after proportional splitting</u>
BZ 1	1%	5%	0%	5%
BZ 2	3%	15%	6,7%	15%
BZ 3	8%	40%	56.6%	40%
BZ 4	2%	10%	0%	10%
BZ 5	6%	30%	36.7%	30%
ALL BZs	20%	TOTAL LF contribution 100%	TOTAL LF contribution 100%	TOTAL LF contribution 100%

1032. An analysis of both methods demonstrates that the Contested Decision’s splitting method complies with Article 16(13) ER, whereas the proportionality method infringes Article 16(13) ER.

1033. Indeed, a proportionally divided common LF threshold renders the concept of a LF threshold obsolete because the contribution of each BZ to the LF costs before and after proportional splitting is the identical. This would be contrary to the requirement of Article 16(13) ER to set a threshold. Additionally, a proportional split of the common LF threshold does not set the LF threshold level in accordance with a situation with no structural congestion because BZs with no structural congestion (e.g. BZ 1) contribute to the costs of RAs. Furthermore, a proportional split of the common LF threshold increases the LF threshold for BZs with a high level of LFs and decreases the threshold for BZs with a low level of LFs, which goes against the PPP and does not give correct incentives for TSOs to reduce LFs below the threshold.

1034. Conversely, the splitting method of the Contested Decision's RDCTCS is in accordance with both the concept of a LF threshold and Article 16(13) ER: it sets the LF threshold level in accordance with a situation with no structural congestion because BZs with no structural congestion (e.g. BZ 1) do not contribute to XRA costs. Furthermore, the splitting method does not penalise BZs which cause a low level of LFs. Such penalisation would go against the PPP and would not give correct incentives for TSOs to reduce LFs below the threshold. The splitting method is therefore in line with Article 16(13) ER and the PPP and also with Article 74 CACM, as it creates the correct incentives to manage congestion and fosters the efficient development and operation of the EU interconnected system and electricity market in the long term (Article 74(6)(a) and (e) CACM), is consistent with the responsibilities and liabilities of Core TSOs (Article 74(6)(b) CACM), ensures a fair distribution of costs and benefits between Core TSOs (Article 74(6)(c) CACM), facilitates adherence to the general principles of CM (Article 74(6)(f) CACM) and complies with the principles of transparency and non-discrimination (Article 74(6)(i) CACM).
1035. Regarding Appellant IV's claim that the LF threshold of the Contested Decision's RDCTCS denies the possibility for TSOs to make a flexible use of the 30% of the capacity, the Board of Appeal refers to Sub-Plea 7.6, which sets out the difference between the 30%-cap and the 10%-threshold and explains that, in any case, the 10%-threshold does not impede TSOs to comply with the 30%-cap. Furthermore, splitting the 10%-threshold per BZ corresponds with Appellant IV's claim in Sub-Plea 7.4 to take account of the specific characteristics of each BZ in order to avoid any discrimination. Given that the test of Article 16(13) ER is based on a situation without structural congestion, splitting in accordance with the Contested Decision's RDCTCS takes due account of the absence of structural congestion in some BZs.
1036. Contrary to Appellant IV's claim, there is not over-penalisation of large BZs, the Board of Appeal finds that splitting as per the Contested Decision's RDCTCS does not give undue privileges to some BZs but correctly takes account of the absence of structural congestion as per Article 16(13) ER. Proportional splitting, on the contrary, penalises BZs without structural congestion, unduly making them contribute to the costs of burdening LFs.
1037. For the same reasons, Appellant IV's claim related to Articles 15(2) ER and 14(1) ER need to be dismissed. These provisions allow for temporary exceptions to allow Member States to tackle structural congestion and high LF levels. However, these temporary exceptions allow for a temporary application of the OPP within the boundaries of the exceptions but do not eliminate Core TSOs' responsibilities for the costs of XRAs in general under the RDCTCS.
1038. Appellant IV's claim related to Article 15(2) ER needs to be dismissed. Appellant IV opposes the Contested Decision's splitting process because it would allegedly go against the fact that Core TSOs of large BZs are given time to tackle their alleged structural congestions by means of linear trajectory or APs.
1039. The Board of Appeal refers to the Second Consolidated Plea for an in-depth analysis of APs in accordance with Article 15(2) ER. As regards the legitimate LF threshold, splitting in accordance with the Contested Decision's RDCTCS takes due account of the absence of structural congestion in some BZs, whereas proportional splitting compels BZs without structural congestion to contribute to XRA costs.
1040. For the same reasons, Appellant IV's claim related Article 14(1) ER needs to be dismissed. Appellant IV opposes the Contested Decision's splitting method because it allegedly contradicts the fact that the EU legislator's intention was not to create small BZs as a means to avoid an undue amount of LFs, but to create BZs without LT structural congestion, unless they have no impact on neighbouring BZs or unless, as a temporary exemption, their impact on neighbouring BZs is mitigated through the use of RAs and those structural congestions do not lead to reductions of CZC in accordance with Article 16 ER.
1041. Article 14(1) ER, entitled "*Bidding zone review*" reads as follows: "*Member States shall take all appropriate measures to address congestions. Bidding zone borders shall be based on long-term, structural congestions in the transmission network. Bidding zones shall not contain such structural congestions unless they*

have no impact on neighbouring bidding zones, or, as a temporary exemption, their impact on neighbouring bidding zones is mitigated through the use of remedial actions and those structural congestions do not lead to reductions of cross-zonal trading capacity in accordance with the requirements of Article 16. The configuration of bidding zones in the Union shall be designed in such a way as to maximise economic efficiency and to maximise cross-zonal trading opportunities in accordance with Article 16, while maintaining security of supply.”

1042. Article 14(1) ER aims at creating BZs without structural congestion. This aim is in accordance with the aim of Article 16(13) ER to penalise burdening flows and set a threshold for burdening flows in the absence of structural congestion. Article 14(1) ER provides that, if a BZ with structural congestion has no impact on neighbouring BZs, this BZ is allowed to have structural congestion. Consequently, as soon as a BZ has an impact on neighbouring BZs, it can no longer contain structural congestion, and appropriate measures should be taken to address this situation. Article 14(1) ER also provides that it is allowed for a BZ to have structural congestion as a temporary exemption, if the impact on the neighbouring BZs is mitigated through the use of RAs. Splitting in accordance with the Contested Decision’s RDCTCS complies with the requirements of this provision as it allows for a legitimate LF threshold in every BZ and accordingly does not penalise BZs causing LFs below this threshold.
1043. Furthermore, Appellant IV’s claim needs to be dismissed according to which the Contested Decision’s splitting process infringes Article 74(6)(c) CACM (which requires the RDCTCS to ensure “*a fair distribution of costs and benefits between the TSOs involved*”) because it over-penalises LF polluting TSOs. As set out above, splitting in accordance with the Contested Decision’s RDCTCS neither over-penalises LF polluting TSOs nor TSOs of large BZs.
1044. Appellant IV’s claim also has to be dismissed according to which the Contested Decision’s splitting process infringes Article 74(6)(f) CACM because it does not facilitate adherence to the general CM principles and is contrary to the PPP of Article 16(13) ER. As set out above and in the Twelfth Coordinated Plea, splitting in accordance with the Contested Decision’s RDCTCS complies with the general CM principles, in particular with the principle of non-discrimination of Article 16(1) ER, with Article 16(13) ER and with the PPP.

7.10 The LF threshold infringes Article 74(6)(f) CACM.

1045. Appellant IV alleges that the failure to comply with Articles 16(8) and (13) ER infringes Article 74(6)(f) CACM, which requires the RDCTCS to facilitate adherence to the general principles of CM as set out in Article 16 ER.
1046. As set out above in Sub-Plea 7.8, the legitimate LF threshold of the Contested Decision’s RDCTCS complies with Article 16(8) and (13) ER and, consequently, complies with Article 74(6)(f) CACM.

7.11 The LF threshold should apply to LFs and IFs.

1047. Appellant II alleges that the threshold should not only apply to LFs but also to IFs. Appellant II claims, in this regard, that Article 16(13) ER refers to all polluting flows, both IFs and LFs, and that the threshold needs to apply to both IFs and LFs.
1048. Appellant VI claims that the legitimate LF threshold set by ACER is unlawful and does not comply with Article 16(13) ER because it should also apply to IFs.
1049. The Board of Appeal notes that, when providing regulatory approval to All Core TSO’s RDCTCS Proposal, there was no need for ACER to review the Proposal in this respect.
1050. ACER acted in accordance with the Explanatory Document accompanying All Core TSOs’ RDCTCS Proposal²¹⁷. Section 4.5.2 of the Explanatory Document, “Treatment of internal flows”, stated “*No Threshold All the internal flows are considered as one and there is no differentiation within them.*” Similarly, in their Non-Paper (Section 1.1)²¹⁸, All Core TSOs with the exception

²¹⁷ Annex 13 to the Defence.

²¹⁸ Annex 79 to the Defence.

of one (Appellant I) – including Appellant VI - agreed that the IF threshold had to be set at 0% or had to be labelled as non-relevant for the cost-sharing process. The debate was centred on the modalities of such threshold. Their Non-Paper held: “Core TSOs commonly agree that internal flows threshold is not needed (or is set to 0%) as internal flows, if they are relevant, should be considered as a whole in the order stack and be subjected to the same cost sharing treatment. In the case that the allocation of internal loop flow costs is not associated to the owner of the line (and if the order stack changes) in the final methodology, the necessity for a threshold on internal flows different than zero percent might arise.” Appellant VI never raised the issue during the bottom-up decision-making process, even though the issue was tabled on several occasions. Given that All TSOs’ choice ensured compliance with the applicable regulatory framework, there was no need for ACER to review the Proposal in this respect.

1051. The issue whether to have a legitimate IF threshold or not is moot insofar as the OPP is applied to IFs: all costs deriving from IFs are born by the owner of the NEs on which they occur. Applying the OPP or the PPP to IFs would place the cost burden on the same TSO because the TSO causing the IF or the polluter is also the owner of the NE.
1052. Also, Article 16(13) ER requires a LF threshold, allowing a portion of acceptable LFs below the threshold and penalising LFs above the threshold on the basis of the PPP because LFs are unavoidable in a zonal model. IFs are not unavoidable in a zonal model. This was set out by All Core TSOs in the Explanatory Document accompanying All Core TSOs’ RDCTCS Proposal²¹⁹: “The electricity network of the Core CCR is highly meshed and in combination with the zonal design of the EU Internal Energy Market a certain level of loop flows is therefore inevitable, even with the most ambitious grid investments. Indeed, such a goal could lead to the target which could be opposite to the goals of internal electricity market (lower investments in cross-border lines). Due to these reasons a threshold for the loop flows could be considered. The consequence of applying a threshold is that a part of the loop flows gets accepted and gets less highly prioritised as the remaining bigger share.” (emphasis added)
1053. The Board of Appeal refers to the First Consolidated Plea (Sub-Plea 1.1.7) regarding the reason why the OPP should apply to IFs.
1054. As set out in All Core NRAs’ Non-Paper, the same stakeholders that opine that the threshold should apply to LFs and IFs opine that LFs should not be prioritised above IFs in the order stack. Supporters of an IF threshold - separating the IF amounts in 2 parts that would be subject to a different cost sharing treatment – also allege that LFs should be deprioritised as compared to IFs, because, in their opinion, both are equally polluting.
1055. The Board of Appeal refers to the Sixth Consolidated Plea (Sub-Plea 6.2) as to the reason why IFs should not be prioritised equally as LFs in the priority stack.

7.12 The LF threshold should comply with the principle of transparency.

1056. Appellant II alleges that the threshold should comply with the requirement of Article 74(3) CACM, i.e. that costs need to be allocated in a manner that is transparent and auditable, in line with the principle of transparency.
1057. The Board of Appeal finds that the 2-step legitimate LF is clear and straight-forward and that it is part of the Contested Decision’s RDCTCS, which is duly monitored according to its Article 10, subject to reporting according to its Article 11 and subject to an annual review in order to identify possible improvements according to its Article 12.

7.13 No replacement of the LF threshold set by ACER.

1058. Appellant IV alleges that the Contested Decision’s RDCTCS foresees the automatic replacement of the individual LF thresholds, based on a common LF threshold, when All Core TSOs determine the legitimate LF threshold pursuant to the study foreseen by Article 16(13) ER but that it does not foresee an automatic replacement of the common LF threshold itself.
1059. Intervener I observes that the Contested Decision’s RDCTCS does not provide how the temporary solution will be replaced.

²¹⁹ Annex 13 to the Defence.

1060. Article 7(5) of the Contested Decision's RDCTCS foresees that the individual thresholds pursuant to paragraph 4 are temporary and will automatically be replaced by the legitimate LF threshold determined by All Core TSOs pursuant to All Core NRAs' approval. Given that the temporary individual threshold is the final outcome of a 2-step calculation involving a preliminary common LF threshold, the latter will automatically become obsolete.

7.14 The LF threshold set by ACER lacks due technical analysis.

1061. Appellant V claims that the common legitimate LF threshold has been arbitrarily set by ACER at 10%. It alleges that the 10%-threshold lacks a technical justification. It views that ACER made an error of assessment because the temporary threshold (i) does not rely on factually accurate, reliable and consistent evidence, (ii) relies on evidence that does not contain all information that had to be taken into account in order to assess a complex situation and (iii) insufficiently substantiated the conclusion drawn from the evidence.
1062. Appellant V furthermore alleges that the 10%-threshold was chosen to reach a majority in ACER's BoR and is the result of a political negotiation, as set out by paragraph 122 of the Contested Decision. Appellant V alleges that ACER implemented a majority decision of the TSOs, contrary to Article 9(3) CACM.
1063. Appellant VI claims that the legitimate LF threshold set by ACER is unlawful and does not comply with Article 16(13) ER because it should have been preceded by a due analysis of Core TSOs.
1064. As set out in Sub-Pleas 7.2 and 7.3, the legitimate LF threshold has not been set by ACER in an arbitrary fashion and is backed-up by a robust technical analysis. It was set after a rigorous analysis of the results of All Core TSOs' Experimentation Report, All Core TSOs' Non-Paper, All Core NRAs' Non-Paper and the results from ACER's own simulations using a variety of parameters and following an extensive consultation with Core TSOs and NRAs. When carrying out its own simulations, ACER simulated the results of other scenarios (by modifying the parameters of this same model) in order to (i) carefully evaluate the different arguments from Core TSOs and NRAs and (ii) investigate alternative options that were compliant with Articles 74 CACM and 16 ER.
1065. The legitimate LF threshold of 10% relies on factually accurate, reliable and consistent evidence, which is based on the results from the analysis done by All Core TSOs in the context of the Experimentation Report, the results from ACER's own simulations and TSOs' expertise and NRAs' input through the exchanges done during consultations (e.g. All Core TSOs' RDCTCS Non-Paper, All Core NRAs' RDCTCS Non-Paper, consultation by ACER of All Core NRAs regarding a higher common LF threshold of 15%, etc.).
1066. Appellant V's claim that the 10%-threshold implemented a majority decision of the TSOs, contrary to Article 9(3) CACM is incorrect. First, as set out in the Fourteenth Consolidated Plea (Sub-Plea 14.2), ACER acts on the basis of Article 6(10) ACER Regulation, upon a referral of All Core NRAs. Hence, the qualified majorities foreseen by Article 9(3) CACM are not relevant to ACER's decision-making but only relevant to All Core TSOs' initial Proposal, submitted to All Core NRAs. Second, it transpires that ACER set the legitimate LF threshold after a rigorous analysis involving external information, internal simulations and an extensive stakeholder consultation.
1067. On Appellant V's claim that the 10%-threshold was not based on a technical analysis but aimed at reaching a majority in the BoR is also erroneous, the Board of Appeal reiterates that ACER set the legitimate LF threshold on the basis of a coherent and objective evidence-based assessment in compliance with the applicable regulatory framework. The obtainment of a favourable opinion from the BoR, which is required under the ACER Regulation, has not prevented the Contested Decision and its RDCTCS to be fully compliant with the relevant legal framework. Yet the Contested Decision is the outcome of ACER's decision-making process, including an extensive consultation process with All Core TSOs and All Core NRAs,

the involvement of ACER's AEWG and ACER's BoR (composed of All NRAs), two-thirds of which decide on whether ACER's draft decision are to be approved. ACER is an agency that is meant to promote cooperation between NRAs.

7.15 The LF threshold infringes Article 74(6)(e) CACM.

1068. Appellant III claims that BZs with large volume of LFs due to their high amount of RES will bear an unjustifiable financial burden in case of a common threshold for acceptable LFs of 10%, infringing the EU goal of an internal energy market that fosters RES. Article 74(6)(e) CACM requires the RDCTCS to “(e) facilitate the efficient long-term development and operation of the pan-European interconnected system and the efficient operation of the pan-European electricity market”.
1069. As set out in the Twelfth Consolidated Plea, Sub-Plea 12.1, the objective of the RDCTCS is not to penalise TSOs from BZs with RES.
1070. The LF threshold is imposed by the law and indispensable for the implementation of the RDCTCS and, given their interaction, the RDCT and the ROSC. An adequate level of coordination in terms of RDCTs and OS can only be achieved through a corollary cost sharing system, as provided for in the RDCTCS and, as set out in the Fourteenth Consolidated Plea, Sub-Plea 14.2, LF threshold is indispensable for the RDCTCS. The RDCTCS plays a role in the identification of the most effective CM measures under CACM and aims to maximise CZC and ensure OS. In so doing, the Contested Decision's RDCTCS has been designed in way that ensures an adequate level of investments in the long term and provides correct economic signals in accordance with 74 CACM and 16 ER, whilst fostering integration of Core CCR in terms of congestions. This adequate level of investments will foster, in the long term, correct investment initiatives by All Core TSOs and a smooth transition of the entire Core CCR towards decarbonisation. Adequate investments are therefore key with respect to RES.
1071. **It follows that the Seventh Consolidated Plea must be dismissed as unfounded.**
1072. Appellants' claims in relation to the infringement of the PPP are dealt with in the Eighth Consolidated Plea.
1073. Appellants' claims in relation to an infringement of the principle of proportionality are dealt with in the Eleventh Consolidated Plea.
1074. Appellants' claims in relation to an infringement of the principle of non-discrimination are dealt with in the Twelfth Consolidated Plea.
1075. Appellants' claims in relation to ACER's competence are dealt with in the Fourteenth and Fifteenth Consolidated Pleas.
1076. Appellants' claims in relation to an infringement of the duty to reason are dealt with in the Seventeenth Consolidated Plea
1077. Appellants' claims in relation to an infringement of the right to be heard are dealt with in the Eighteenth Consolidated Plea.

Eighth Consolidated Plea – Polluter Pays Principle.

1078. Appellant VI²²⁰ claims that the Contested Decision's RDCTCS infringes the PPP as regards (i) the scope of the RDCTCS and the determination of XNEs and (ii) the inclusion of NEs covered by Action Plans in the RDCTCS scope.
1079. In its Defence²²¹, ACER responds that the Contested Decision's RDCTCS complies with the PPP as regards its scope and lawfully included NEs covered by APs in the RDCTCS scope

8.1 RDCTCS scope.

1080. Appellant VI alleges an infringement of the PPP due to the scope of the RDCTCS and the determination of XNEs

²²⁰ Appeal VI, Plea 5, paras 209-241.

²²¹ Defence, paras 280-311.

1081. Appellant VI claims that LFs are over-penalised in comparison with IFs due to the scope of the RDCTCS, which allows cost sharing on internal NEs. It holds that “TSOs responsible for the initial internal congestion must continue to bear the costs of actions to remedy that congestion on internal NEs.” It alleges that, by including internal NEs as eligible for cost sharing, ACER has failed to acknowledge that internal NEs may be congested solely as a result of IFs and not just due to LFs resulting from internal trade within another BZ. In its view, it is wrong to assume that in most cases internal NEs are sufficient to accommodate both domestic internal trade and CZ trade. Appellant VI furthermore invokes the application of Article 16(4) and 16(8) ER in order to support this stance.
1082. In its Reply, Appellant VI states that ACER “claims, without reference to any legal basis, that it can pick which cost sharing principle should be applied to the cost sharing methodology”.²²²
1083. The Board of Appeal refers to the First Consolidated Plea, in particular Sub-Plea 1.1.7, regarding the correct application of the PPP and to the Fourteenth Consolidated Plea, in particular, Sub-Plea 14.1, regarding ACER’s competence in relation to the RDCTCS scope.
1084. The Board of Appeal refers to Sub-plea 1.7 of the First Consolidated Plea regarding the application of Articles 16(4) and (8) ER to the RDCTCS scope.
1085. As set out in the First Consolidated Plea, Sub-plea 1.6, and the Twelfth Consolidated Plea, Sub-plea 12.1, one should carefully differentiate between the scope, on the one hand, and the distribution of costs, on the other hand.
1086. Regarding the scope, all XNEs should be included, also internal XNEs (which host and cause a variety of flows, not only IFs). Appellant VI’s claim that the scope of the RDCTCS should be narrowed down in order to reduce the penalisation of LFs is contrary to the CACM, which requires a cost sharing solution for XNEs, and the ER, which requires due application of the PPP when sharing costs among TSOs regarding burdening LFs. By removing internal XNEs from the scope of the RDCTCS, TSOs causing LFs that congest those internal XNEs would not be accountable under the PPP and a situation of free-riding would be created.
1087. Regarding the distribution of costs, the Contested Decision’s RDCTCS duly complies with the PPP because it (i) sets a *de minimis* threshold for LFs above which they contribute to the costs, whereas it does not set any threshold for IFs; (ii) prioritizes LFs above the threshold, which come first in the flow stack, over IFs, which come second in the flow stack; and (iii) applies the PPP to LFs above the threshold and applies the OPP to IFs. Given the fact that IFs are created by internal transactions in the BZ of the network-owning TSO, applying the OPP or the PPP to IFs would place the cost burden on the same TSO.
1088. At the Oral Hearing, Appellant VI stated that ACER uses interpretative techniques to circumvent the language of Article 16(13) ER. It also held that the sub-set of NEs subject to the RDCTCS is an exception and that the Contested Decision’s broader scope downplays the exceptional nature of this sub-set.
1122. The Board of Appeal notes, in that regard, that the textual wording of Article 16(13) ER does not limit the application of the PPP exclusively to congestions between 2 BZs. It does not impede the application of the PPP to other congestions than congestions between 2 BZs. It simply requires the application of the PPP to congestions between 2 BZs. A literal interpretation of Article 16(13) ER specifies the elements of a cost sharing solution for congestions between 2 BZs observed but it does not contain any prohibition regarding the adoption of a other cost sharing solutions. Moreover, as set out in the First Consolidated Plea, the application of the PPP to the full scope of the RDCTCS is confirmed by contextual, teleological and historic interpretations, which require the RDCTCS to apply the PPP to the full scope of XNEs²²³.

²²² Reply of Appellant VI, para 40.

²²³ H.G. Schermes, D.F. Waelbroeck, “Judicial Protection in the European Union” (2001); N. Fennelly, “Legal Interpretation at the European Court of Justice”, Fordham International Law Journal Volume 20, Issue 3 1996; A. Albers Llorens, “The European Court of Justice, More than a Teleological Court”, Cambridge University Press,

1089. Appellant VI erroneously reverses the PPP and applies it to the polluting flow-hosting TSOs, which Article 16(13) ER does not identify as polluters that should contribute to the RDCTCS. In the absence of IFs or LFs from polluting flow-causing TSOs, the internal NEs of the polluting flow-hosting TSOs would not be congested. Article 16(13) ER does not define pollution as a lack of maintenance or investment. Pollution is clearly defined as the contribution to the congestion through electricity flows.

8.2 Unlawful inclusion of NEs covered by Action Plans in the RDCTCS scope.

1090. Appellant VI alleges an infringement of the PPP because of the inclusion of NEs covered by APs the scope of the RDCTCS.

1091. Appellant VI states that, contrary to the requirements of Article 15 ER, pursuant to the Contested Decision's RDCTCS, costs may be wrongly allocated to TSOs in another Member State due to (i) the scope of the RDCTCS which includes internal NEs and (ii) the penalisation of LFs on both XNEs and internal NEs. In its view, this renders a Member State's obligation to address internal congestion at its own cost as required by Article 15(6) ER redundant. Appellant VI also invokes Recital 31 (ER).

1092. Article 15(6) ER reads as follows: *"On the basis of the methodology and assumptions approved pursuant to paragraph 5, the transmission system operators participating in the bidding zone review shall submit a joint proposal to the relevant Member States or their designated competent authorities to amend or maintain the bidding zone configuration no later than 12 months after approval of the methodology and assumptions pursuant to paragraph 5. Other Member States, Energy Community Contracting Parties or other third countries sharing the same synchronous area with any relevant Member State may submit comments."*

1093. Recital (31) ER reads as follows: *"To reflect the divergent principles of optimising bidding zones without jeopardising liquid markets and grid investments two options should be provided for in order to address congestion. Member States should be able to choose between a reconfiguration of their bidding zone or measures such as grid reinforcement and grid optimisation. The starting point for such a decision should be the identification of long-term structural congestions by the transmission system operator or operators of a Member State, by a report by the European Network of Transmission System Operators for Electricity (the 'ENTSO for Electricity') on congestion or by a bidding zone review. Member States should first try to find a common solution on how to best address congestion. In the course of doing so Member States might adopt multinational or national action plans to address congestion. For Member States which adopt an action plan to address congestion, a phase-in period in the form of a linear trajectory for the opening of interconnectors should apply. At the end of the implementation of such an action plan, Member States should have a possibility to choose whether to opt for a reconfiguration of the bidding zone(s) or whether to opt for addressing remaining congestion through remedial actions for which they bear the costs. In the latter case their bidding zone should not be reconfigured against the will of that Member State, provided that the minimum capacity is reached. The minimum level of capacity that should be used in coordinated capacity calculation should be a percentage of the capacity of a critical network element, as defined following the selection process under Regulation (EU) 2015/1222, after, or, in the case of a flow-based approach, while, respecting the operational security limits in contingency situations. A Commission decision on the configuration of a bidding zone should be possible as a measure of last resort and should only amend the configuration of a bidding zone in those Member States which have opted to split the bidding zone or which have not reached the minimum level of the capacity."*

1094. In Appellant VI's view, the inclusion of all RDCT costs to meet APs in the RDCTCS scope is contrary to the PPP, unless the eligible costs for cost sharing are further delineated to ensure that necessary incentives remain in place for Member States to resolve the structural congestion in their own networks and meet AP requirements. It claims that the inclusion of internal NEs in the RDCTCS scope renders a breach of the PPP more likely because congestions on internal NEs are caused by LFs and IFs and both should be penalised.

1095. Paragraphs 78 and 79 of the Contested Decision read as follows:

2017;; Case 26/62 *Van Gend en Loos* ECLI:EU:C:1963:1; Case 6/64 *Costa v. ENEL* ECLI:EU:C:1964:66; Case 26/69 *Stauder v Ulm*, ECLI:EU:C:1969:57; Case 55/87 *Moksel v. BALM*, ECLI:EU:C:1988:377; Case C-89/81 *Hong Kong Trade*, ECLI:EU:C:1982:121; Case C-101/01 *Lindqvist* ECLI:EU:C:2003:596; Case C-409/06 *Winner Wette* ECLI:EU:C:2010:503; Case C-402/07 *Sturgeon and Others*, ECLI:EU:C:2009:716; Case C-439/08 *VEBIC* ECLI:EU:C:2010:739; Case C-41/09 *European Commission and Kingdom of the Netherlands*, ECLI:EU:C:2011:108; Joined Cases C-188/10 and C-189/10 *Melki and Abdeli* ECLI:EU:C:2010:363; Case C-583/11 *P Inuit Tapiriit Kanatami and Others*, ECLI:EU:C:2013:625.

- “(78) ACER considers that the costs of remedial actions which are not stemming from making available the required level of cross-zonal capacities should still be subject to cost sharing in accordance with the cost sharing methodology. With this regard ACER notes that the adopted cost sharing methodology by default allocates all the costs attributed to a specific network element to the TSO which owns such network element (i.e. the TSO in whose control area such network element is connected or located), except for the costs which are caused by congestions created by loop flows originating from other bidding zones. These costs are then borne by the TSOs of these other bidding zones that create such loop flows.
- (79) ACER understands that the remedial actions, which are required to address congestions caused by loop flows from other bidding zones cannot be considered as remedial actions necessary to achieve the linear trajectory as stipulated by Article 15(3) of the Electricity Regulation. This is because the action plan and the related linear trajectory are designed to address the congestion⁸ identified within the bidding zone(s) of the concerned Member State in accordance with Article 15(1) and (2) of the Electricity Regulation. The action plan and linear trajectory therefore reflect the (high level of) loop flows and internal flow caused by the bidding zone of such Member State and they are not designed to solve the physical congestion problems that are caused by loop flows from other bidding zones. The action plan should gradually reduce the level of loop flows and internal flow resulting from the bidding zone of a Member State applying the action plan, which should allow for a gradual increase of cross-zonal capacities. However, this may not be possible if during this period the loop flows from other bidding zones would increase and no cost sharing with polluter-pays principle would be applied for these loop flows. Excluding all network elements concerned by the action plan from the cost sharing would not allow the Member State applying the action plan to increase cross-zonal capacities, because there would be no cost sharing for congestions caused by loop flows originating from neighbouring bidding zones. Such a solution would, on the other hand, provide perverse incentives to neighbouring Member States. With this respect, Article 15(3) of the Electricity Regulation does not aim at contradicting the polluter-pays principle in case of action plans, but rather to safeguard and reinforce it.”
1096. The Board of Appeal refers to the Second Consolidated Plea on the unlawful inclusion of internal NEs covered by APs. First, Article 15 ER is part of the CC process, whereas the RDCTCS is part of the CROSA process, which occurs closer to the delivery of electricity.
1097. Article 15 ER amounts to an exception from the PPP (i.e. a temporary allowance of the OPP) in order to guarantee maximum capacity levels by 2025. APs and their related linear trajectory are designed to address structural congestion in a BZ (or BZs) of a Member State and are not related to physical congestion caused by LFs from other BZs, which are unpredictable.
1098. The Board of Appeal finds that there is no reason justifying the application of the OPP in situations not covered by the express wording of Article 15 ER. Yet there are reasons to apply the PPP to these situations: physical congestions caused by LF from other BZs (over a certain threshold) hinder APs. As set out by ACER in its Defence, “the action plan relates to the actions of a Member State by which it is able to comply with the 70% target (e.g., network investments), but if the network of such Member State is continuously polluted by loop flows from other bidding zones, there is no action that a Member State can do to achieve the 70% target”²²⁴. Article 15 ER does not aim at contradicting the PPP in case of APs, but rather at safeguarding and reinforcing it.
1099. Appellant VI’s claim that the inclusion of internal NEs infringes Article 74(6)(a) CACM which requires the RDCTCS to “provide incentives to manage congestion, including remedial actions and incentives to invest effectively” is flawed. APs have to be encouraged as they foster the attainment of minimum CZC capacity in 2025. If LFs from other BZs hamper APs, they should be discouraged in order to allow APs to attain their long term objective to increase CZC in a Member State. LFs from other BZs are discouraged by having their costs shared and included in the RDCTCS. It is erroneous to hold that the inclusion of LFs from other BZs in cost sharing would discourage TSOs from Member States with APs (relying on their exception) from developing measures to address congestions in order to increase CZC. That is precisely what APs are designed for: the development of short term measures to address structural congestion in a Member State and to allow this Member State to gradually increase CZC and attain the 70%-threshold in the long term. Excluding LFs from other BZs from cost sharing under the RDCTCS would not provide the necessary incentives to neighbouring Member States to take measures to reduce polluting LFs. Member States owning XNECs with APs may not be able to increase CZC, despite the requirement of Article 15(2) ER, because APs

²²⁴ Defence, Plea 1, para 305.

are unable to reduce LFs from neighbouring BZs, and Member States from which LFs originate would not be incentivised to invest or change their BZ configuration in order to avoid such LFs, in violation of Article 74(6)(b) CACM.

1100. Appellant VI’s claim must be dismissed, according to which the inclusion of internal NEs infringes Article 74(6)(b) CACM, which requires the RDCTCS to “be consistent with the responsibilities and liabilities of the TSOs involved”. This is because the Contested Decision’s RDCTCS includes LFs from other BZs above the threshold in cost sharing and applies the PPP to these situations. This is in line with the responsibility and liability of TSOs for physical congestions caused by LFs. Doing otherwise would unlawfully place a burden on Member States implementing APs which is fully unrelated to APs and, moreover, hinders those APs of producing the desired effects.
1101. In its Reply, Appellant VI states that “it endorses ACER’s reading of Article 15(3), as presented in points 299-301 of the Defence, but contrary to ACER’s assertions, (Defence, paras. 305 -311) its Methodology does not split and then allocate the costs of remedial actions between those necessary to make available the linear trajectory or to make available cross-zonal capacity at the borders or on critical network elements concerned by the action plan and those remedial actions identified to relieve structural congestion. As a result, the former category of costs may well be borne by a TSO other than the TSO owner of the network element subject to an action plan. This is because the burdening loop flows above the threshold are prioritised first with no consideration of netting with the relieving loop flows. This is a clear breach of the polluter pays principle”²²⁵.
1102. In other terms, Appellant VI endorses ACER’s reasoning but claims that the Contested Decision is not designed in a way that will provide a correct outcome in accordance with ACER’s reasoning.
1103. Appellant VI illustrates this with the following example²²⁶:

- “a. Consider an XNE owned by TSO A and subject to an action plan whose linear trajectory is 50% of the thermal capacity (Fmax) at this time. The Fmax of this XNE is 1000 MW.
 b. This XNE is overloaded since the observed capacity is of 1050MW. This can be explained by the following flows distribution:

Type of flows	MW	comments
Commercial Flows	500	Market actors exchanges require the whole capacity set in the linear trajectory (50% Fmax)
Internal Flows (TSO A)	600	
Loop flows (TSO B)	150	Burdening loop flows: based on the LF threshold of 10%, 50MW of this flow is prioritised
Loop flows (TSO C)	-200	Relieving loop flows

- c. Consider here a scenario with a burdening and relieving loop flows (respectively from TSO B and TSO C) – a frequent occurrence, as observed in the TSOs’ RDCT experimentation report.³⁸

The Methodology would lead to the following flows order stack to allocate the remedial actions costs to relieve the congestion:

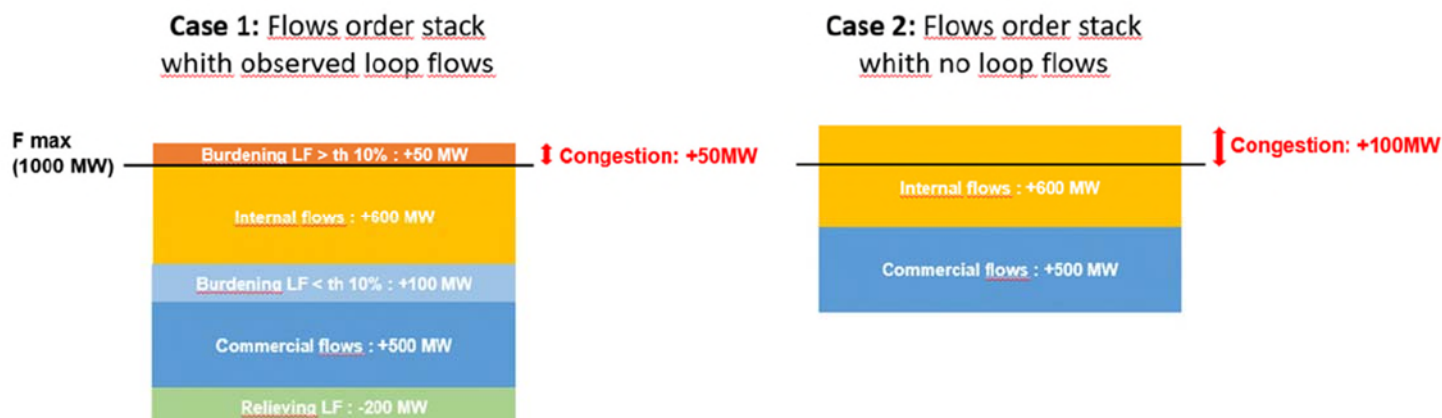

²²⁵ Reply of Appellant VI, para 42.

²²⁶ Reply of Appellant VI, paras 43-46.

Then, in **Case 1** which corresponds to the observed situation for this XNE, the distribution of costs would lead to allocate 100% of the costs to TSO B whereas TSO A would have no cost. But, in case 2 in the absence of loop flows, the XNE would be still overloaded by 100 MW because of the combination of internal and commercial flows.

Case 2 shows that remedial actions are necessary to make available the capacity defined in the linear trajectory for this XNE (as required by Article 15(3)). But when applying ACER's Methodology as in case 1, TSO A has no costs and TSO B bears all the costs. This Methodology cannot be deemed compliant with Article 15(3). This is because the burdening loop flows above the threshold are prioritised first with no consideration of netting with the relieving loop flows. RTE submits that there are two solutions that ACER could have adopted to ensure compliance with Article 15(3). First, and in the absence of netting, the prioritisation of the internal flows at the same level as for the burdening loop flows ensures that a TSO owner of a XNE subject to an action plan will always bear at least some of the costs to make available the linear trajectory. Second, a netting solution (per category of flows) would avoid case 1-type situations where only the TSO responsible for burdening loop flows bears all the costs and the TSO owner of the XNE subject to an action plan bears no cost at all – contrary to Article 15(3).”

1104. The Board of Appeal observes that the Contested Decision's RDCTCS complies with Article 15(3) ER in both scenarios of Case 1 and Case 2. Whether there is an AP or not is not relevant for the example. The same scenarios would arise if the XNEC of the example were not concerned by an AP: IFs would contribute more to the costs in Case 2 than in Case 1. The real issue at stake is whether or not the same category of flows – in this case relieving and burdening LFs - needs to be netted, as set out by Appellant VI: “This is because the burdening loop flows above the threshold are prioritised first with no consideration of netting with the relieving loop flows”. The Board of Appeal refers to the Fifth Consolidated Plea, which sets out in detail why there is not legal ground, such as Article 15(3) ER, that justifies that the relieving LFs of the BZ of TSO C should benefit to the BZ of TSO B and why such additional netting process would artificially reduce burdening LFs and not be in line with the PPP, the responsibilities and liabilities of the TSOs involved, the principle of non-discrimination, the general CM principles and other applicable regulatory requirements.
1105. **It follows that the Eighth Consolidated Plea must be dismissed as unfounded.**

Ninth Consolidated Plea – Lack of timescale to implement the RDCTCS.

1106. Appellant II²²⁷ claims that the Contested Decision's RDCTCS fails to provide a timescale for the implementation in the Contested Decision itself, given that it refers to the implementation timescale of ACER Decisions 33/2020 (ROSC) and 35 (RDCT). It also claims that the ROSC and RDCT had not yet been adopted at the time of the voting of the RDCTCS by ACER's BoR on 18 November 2020. Appellant II claims that is contrary to legal certainty and infringes Article 9(9) CACM.
1107. In its Defence²²⁸, ACER responds that the Contested Decision's RDCTCS complies with the requirement of Article 9(9) CACM to provide a proposed timescale for its implementation and that ACER's BoR had full knowledge of the implementation timeline of the Contested Decision's RDCTCS when casting its favourable vote on 18 November 2020.
1108. Article 9(9) CACM reads as follows: “The proposal for terms and conditions or methodologies shall include a proposed timescale for their implementation and a description of their expected impact on the objectives of this Regulation. Proposals on terms and conditions or methodologies subject to the approval by several or all regulatory authorities shall be submitted to the Agency at the same time that they are submitted to regulatory authorities. Upon request by the competent regulatory authorities, the Agency shall issue an opinion within three months on the proposals for terms and conditions or methodologies.”
1109. Article 9(9) CACM requires that the RDCTCS includes a “proposed timescale for its implementation”. In other terms, the RDCTCS has to include a timescale, but this timescale is not definitive and can be subject to amendments in future.
1110. Article 13(2) of the Contested Decision's RDCTCS reads as follows:

²²⁷ Appeal II, Plea 3, paras 80-84.

²²⁸ Defence, paras 745-780.

“2. This cost sharing methodology shall be implemented by the implementation deadline as defined in the methodology pursuant to Article 35 of the CACM Regulation and the methodology pursuant to Article 76 of the SO Regulation.

3. The implementation process for this cost sharing methodology, which shall start with the entry into force of this methodology and finish by the deadline in accordance with paragraph 2, shall ensure provision of regular information to Core regulatory authorities and stakeholders on the development and testing of this methodology. It shall also provide to Core regulatory authorities regular reports on the results of testing.”

1111. There is legal certainty: both the starting date and the end date are certain. The implementation process starts with the entry into force of the RDCTCS, i.e. 4 December 2020²²⁹, and ends by the implementation deadline of the RDCT (ACER Decision 35/2020) and the ROSC (ACER Decision 33/2020), which contains a two-stage implementation process, the first step of 30 months ending on 4 June 2023 and the second step of 24 additional months ending on 4 June 2025. In addition, the implementation timescale provides leeway for the RDCTCS’ implementation through a maximum deadline by which the implementation should be finished. However, nothing impedes the implementation process to finish earlier than the maximum end dates.
1112. The implementation timescale is a “*proposed*” timescale. It is not definitive and can be reviewed pursuant to an amendment under Article 12 of the Contested Decision’s RDCTCS. Those amendments also follow a bottom-up decision-making process initiated by All Core TSOs and submitted for approval to Core NRAs.
1113. With respect to the comment that Appellant II tabled at the 95th BoR meeting of 18 November 2020 and joined as annex to its appeal, it reads as follows: “*CRE requests that the implementation timeline is defined in the Core/SEE RDCT cost sharing methodologies themselves, as opposed to the current situation where they are defined only in ACER’S decision on ROSC (SO 76) and RDCT coordination (CACM 35). To comply with the requirement of Article 9(9) of CACM, which foresees that a methodology proposal should include a timescale for implementation, Article 13 (covering the implementation) should specify that the RDCT cost sharing methodologies will be implemented by a given deadline, such as the date by which a robust version of the ROSC/RDCT coordination tools will be available*”.²³⁰ In its comment, Appellant II acknowledges that Article 9(9) CACM requires that the RDCTCS should specify that it will be implemented by a deadline, such as “*the date by which a robust version of the ROSC/RDCT coordination tools will be available*”²³¹. Appellant II does not challenge that the implementation timescale of the RDCTCS is tied to the implementation timescale of the ROSC and RDCT. Even though the comment did not reach the required two-thirds majority for its adoption²³², the Contested Decision’s RDCTCS does not go counter the comment given that it ties the implementation of the RDCTCS to a date by which a robust version of the ROSC and RDCT will be available.
1114. Finally, Appellant II claims that the BoR lacked knowledge on the RDCTCS’s implementation timescale when issuing its favourable vote to the RDCTCS on 18 November 2020 because the RDCTCS’ implementation timescale is linked to the implementation of the ROSC and the RDCT and because the BoR issued a favourable vote on those methodologies at a later date, on 4 December 2020.
1115. First, the stakeholders during the RDCTCS, ROSC and RDCT decision-making processes, including the BoR approval process, are identical stakeholders. Hence, the same Core NRAs involved in the consultations on the RDCTCS were also involved in the consultations on the ROSC and RDCT. The decision-making process of the RDCTCS and the RDCT were carried out simultaneously (Core TSO RDCTCS and RDCT Proposal on 22 February 2019 and a single Core NRAs RDCTCS/RDCT Paper on 27 March 2020). Moreover, at the 95th BoR meeting of 18 November 2020, the attendees were not only provided with the draft RDCTCS

²²⁹ Confirmed by ACER in its response to the Board of Appeal’s First Request for Information.

²³⁰ Annex III to Appeal II.

²³¹ Appeal II, Plea 3, paras 80-84.

²³² https://acer.europa.eu/Official_documents/BoR/Meeting_Docs/A20-BoR-95-02.pdf, see also Annex 82 to the Defence

decision, but also with the draft ROSC decision and the draft RDCT decision. On 18 November 2020, even though voting was limited to the Contested Decision, Point 4.4. of the Agenda had foreseen discussions on the ROSC and RDCT²³³. Those discussions were held, as demonstrated by the Minutes of the 95th BoR meeting: “*The Director presented the state of play relating to the Core and SEE methodologies on ROSC and the Core methodology on coordination of redispatching and countertrading, which aim to ensure coordination of operational security in Core and South-East Europe, and remedial actions in the Core CCR. The AEWG advice broadly endorses the draft decisions, which will be adopted via an electronic procedure to meet the 5 December deadline. The BoR Chair invited members to agree to the use of the electronic procedure, and opened the floor for discussion. The BoR agreed to the use of the electronic procedure.*”²³⁴ In any event, the BoR members were aware of the linking of the RDCTCS’ implementation timescale to the implementation of the ROSC and RDCT since a long time given that the first draft RDCTCS decision that ACER’s Director submitted to the BoR in September 2020 contained an identical proposed timescale in its Article 13²³⁵.

1116. The Board of Appeal concludes that the implementation timescale of the Contested Decision’s RDCTCS provides legal certainty and does not infringe Article 9(9) CACM.

1117. **It follows that the Ninth Consolidated Plea must be dismissed as unfounded.**

Tenth Consolidated Plea – Definition of new implementation timeline.

1118. Appellant VI²³⁶ claims that ACER has breached Article 9(9) CACM and the principle of proportionality by obliging All Core TSOs to commit to a defined implementation timeline at the point of adoption of the Contested Decision’s RDCTCS, a decision which it had no legal basis to take.

1119. In its Defence²³⁷, ACER responds that the Contested Decision’s RDCTCS complies with the requirement of Article 9(9) CACM to provide a proposed timescale for its implementation.

1120. Article 9(9) CACM reads as follows: “*The proposal for terms and conditions or methodologies shall include a proposed timescale for their implementation and a description of their expected impact on the objectives of this Regulation. Proposals on terms and conditions or methodologies subject to the approval by several or all regulatory authorities shall be submitted to the Agency at the same time that they are submitted to regulatory authorities. Upon request by the competent regulatory authorities, the Agency shall issue an opinion within three months on the proposals for terms and conditions or methodologies.*”

1121. Article 9(9) CACM requires that the RDCTCS includes a “*proposed timescale for its implementation*”. In other terms, the RDCTCS has to include a timescale, but this timescale is not definitive and can be subject to amendments in future.

1122. Article 13(2) of the Contested Decision’s RDCTCS reads as follows:

“2. This cost sharing methodology shall be implemented by the implementation deadline as defined in the methodology pursuant to Article 35 of the CACM Regulation and the methodology pursuant to Article 76 of the SO Regulation.

3. The implementation process for this cost sharing methodology, which shall start with the entry into force of this methodology and finish by the deadline in accordance with paragraph 2, shall ensure provision of regular information to Core regulatory authorities and stakeholders on the development and testing of this methodology. It shall also provide to Core regulatory authorities regular reports on the results of testing.”

1123. The implementation process starts with the entry into force of the RDCTCS, i.e. 4 December 2020, and ends by the implementation deadline of the ROSC (ACER Decision 33/2020) and the RDCT (ACER Decision 35/2020), which both contain an identical two-stage implementation process, the first step of 30 months ending on 4 June 2023 and the second step of 24 additional months ending on 4 June 2025. This is confirmed by Article 37 ROSC and Article 37 RDCT as well as in ACER Decision 33/2020 (paragraphs 165-171) and ACER Decision 35/3030 (paragraphs 105-125). The implementation timescale provides leeway for

²³³ https://acer.europa.eu/Official_documents/BoR/Meeting_Docs/A20-BoR-95-01.pdf

²³⁴ https://acer.europa.eu/Official_documents/BoR/Meeting_Docs/A20-BoR-95-02.pdf, see also Annex 82 to the Defence

²³⁵ Annex A.2.2 of Appeal VI.

²³⁶ Appeal VI, Plea 6, paras 242-267.

²³⁷ Defence, paras 745-780.

the RDCTCS's implementation through a maximum deadline by which the implementation should be finished. Nothing impedes the implementation process to finish earlier than the maximum end dates.

1124. The implementation timescale is a "proposed" timescale. It is not definitive and can be reviewed pursuant to an amendment under Article 12 of the Contested Decision's RDCTCS. Those amendments also follow a bottom-up decision-making process initiated by All Core TSOs and submitted for approval to Core NRAs.

1125. Appellant VI's argument according to which the Contested Decision's RDCTCS should have maintained the implementation timescale of All Core TSOs' RDCTCS Proposal is immaterial. Article 14 of All Core TSOs' Proposal did not contain an implementation timescale but only contained (i) an obligation to publish the RDCTCS (Article 14(1)); (ii) an obligation to amend the RDCTCS during the year following its approval or as soon as the details requiring clarification are available, including an obligation to include "a detailed time plan for implementation" "in accordance with Article 9(13) of the CACM guideline" (Article 14(2)) and (iii) a statement that the RDCTCS' implementation is conditional upon regulatory approval of the RDCTCS (Article 9 CACM), of the RDCT (Article 35(1) CACM), of the CCM (Articles 20 and 21 CACM), of the CSAM (Article 75(1) SO), of the ROSC (Article 76(1) SO) and of the development, testing and implementation of IT tools, systems and procedures required to support the RDCTCS (Article 14(3)):

"Article 14 Implementation

1. Core TSOs shall publish this Cost Sharing Methodology without undue delay after its approval in accordance with article 9(10), articles 9(11) or 9(12) of the CACM guideline.

2. This Cost Sharing Methodology shall be amended by Core TSOs no later than 12 months after its approval, or as soon as the details that require clarification are available, whichever happens earlier. This amendment shall also contain a detailed time plan for implementation in accordance with Article 9(13) of the CACM guideline.

3. The implementation of the Cost Sharing Methodology is subject to: a. Regulatory approval of this Cost Sharing Methodology in accordance with Article 9 of CACM guideline; b. Regulatory approval of the Core RD and CT Methodology pursuant to Article 35(1) of CACM guideline in accordance with Article 9 of CACM guideline; c. Regulatory approval of common coordinated capacity calculation methodology required by Articles 20 and 21 of CACM guideline in accordance with Article 9 of CACM guideline; d. Regulatory approval of the coordinated security analysis methodology pursuant to Article 75(1) of SO guideline, its implementation, the regulatory approval of the methodology for regional operational security coordination pursuant to Article 76(1) of SO guideline and its implementation; e. Development, testing and implementation of the IT tools, systems and procedures required to support the Cost Sharing Methodology"

1126. The Explanatory Document to All Core TSOs' RDCTCS Proposal²³⁸ states in the same line: "In article 14 of the submitted methodology, Core TSOs commit themselves to submit an amended version of this methodology, no later than 12 months after its approval or after an agreement is reached on the details of the cost sharing application (whichever happens earlier)."

1127. That is precisely why ACER introduced a proposed implementation timescale in the Contested Decision's RDCTCS. This is confirmed by paragraphs 155 to 157 of the Contested Decision:

"(155) In its Article 14, the Proposal defines the deadline for publication of the cost sharing methodology according to the Articles 9(10), 9(11) and 9(12) of the CACM Regulation. This Article also contains a proposal for the amendment of the cost sharing methodology twelve months after its approval, which would also include a detailed implementation timeline, which would be subject to approval by Core regulatory authorities. Further, this Article contains a number of conditions for the implementation of the cost sharing methodology, which serve as an indication or information on what is needed to implement this methodology.

(156) The Proposal therefore contains the obligation for publication of the methodology. However, the Proposal does not contain the timescale for implementation as required by Article 9(9) of the CACM Regulation. For this reason, ACER specified clearly the timescale for the implementation of the cost sharing methodology. After consultation with Core TSOs and regulatory authorities, ACER was informed that cost sharing methodology is conditional on the implementation of the methodology pursuant to Article 35 of the CACM Regulation and the methodology pursuant to Article 76 of the SO Regulation. ACER therefore clarified that the implementation of the cost sharing methodology shall be done by the same deadline as the implementation of these two methodologies.

²³⁸ Annex 13 to the Defence, p. 55.

(157) In Article 13 of the adopted cost sharing methodology, ACER also introduced, at the request of some Core regulatory authorities, additional requirements that TSOs need to meet during the implementation of the cost sharing methodology. These include the requirements on the provision of regular information and reports to Core regulatory authorities regarding development, implementation and testing of the cost sharing methodology. This is required to provide Core regulatory authorities with sufficient perspective on the impact of cost sharing methodology on the national transmission tariffs, which they are competent to set or fix.”

1128. Furthermore, the introduction of a proposed implementation timescale does not contradict All Core TSOs’ RDCTCS Proposal, which made implementation conditional upon regulatory approval in accordance with Article 9 CACM. Indeed, ACER ensured compliance with Article 9(9) CACM through the introduction of a proposed timescale prior to its regulatory approval of the RDCTCS.
1129. Appellant VI errs when alleging that All Core TSOs’ RDCTCS Proposal rightly did not contain an implementation timescale but an obligation to amend the RDCTCS and that, given that this amendment would include the insertion of an implementation timescale, this would suffice to comply with the requirement of a proposed timescale by Article 9(9) CACM.
1130. It is correct that a proposed timescale implies that the timescale is not definitive. Both Appellant VI and ACER agree on that. However, the possibility to amend the proposed timescale at a later stage should not root out the existence of a timescale in the first place. This is even the more true in a bottom-up decision-making process, whereby the amendment at a later stage will be based on developments and feedback on the methodology’s implementation (as mentioned in Article 14(3) of All Core TSOs’ RDCTCS Proposal: “*development, testing and implementation of IT tools, systems and procedures*”), allowing for All Core TSOs to submit an amendment proposal that will require regulatory approval. Article 37(5) ROSC and Article 37(5) RDCT foresees development, testing and implementation of the IT tools in both steps of the implementation. Appellant VI’s pre-emptive approach advocating that there is no need to include elements in a methodology if they can be modified at a later stage is moot, even more so in bottom-up decision-making processes which, as a rule, allow for amendments down the line in order to adapt to developments. Reasoning otherwise would bring about a chain of deadlock situations, whereby the inclusion of amendable elements of methodologies could be postponed *ad eternum*. Amendment clauses in methodologies would *de facto* postpone their implementation. In the case at hand, following Appellant VI’s reasoning would mean that the amendment process would uphold the methodology’s implementation all in all, which would not only not be able to start until the end of the amendment’s decision-making process, but would also not enable stakeholders to take stock of the implementation of the RDCTCS when deciding upon the amendment.
1131. A distinction has to be made between the requirement of a proposed implementation timescale required by Article 9(9) CACM, on the one hand, and the requirement of a possibility to amend the methodology required by Article 9(13) CACM, on the other hand. Article 9(13) CACM foresees that All Core TSOs or NRAs may request amendments to the RDCTCS, which will be subject to a consultation and require regulatory approval. The Contested Decision’s RDCTCS complies with Article 9(9) CACM by introducing a proposed implementation timescale in its Article 13 and complies with Article 9(13) CACM by introducing a possibility to amend the methodology in its Article 12. The Board of Appeal observes that All Core TSOs’ RDCTCS Proposal acknowledges that the possibility of an amendment of the implantation timescale ensures compliance “*with Article 9(13) CACM*”, and not Article 9(9) CACM.
1132. Article 12 of the Contested Decision’s RDCTCS requires All Core TSOs to perform an annual review of methodology in order to identify possible improvements in, *inter alia*, “*deadlines regarding the delivery of data and information*” and “*deadlines regarding the settlement process*” and to develop and submit to All Core NRAs in parallel a proposal for amendment of the RDCTCS “*within twelve months of the implementation of the cost sharing*

methodology". Appellant VI's reasoning would create an irresolvable deadlock given that the deadline of twelve months to table an amendment would not be able to start running in the absence of any implementation timescale at all. Furthermore, as highlighted above, in the absence of any implementation prior to the amendment, All Core TSOs and NRAs would not be able to carry out an initial analysis of its general compliance with its objectives and purpose, its effectiveness, its efficiency and the quality of its cost estimations as foreseen by Article 12(1) of the Contested Decision's RDCTCS, let alone to take stock of those results in order to amend the RDCTCS in accordance with Article 12(2) of the Contested Decision's RDCTCS.

1133. Appellant VI's argument according to which the Contested Decision's RDCTCS should not have linked its proposed implementation timescale to the implementation of the ROSC (ACER Decision 33/2020) and RDCT (ACER Decision 35/2020) is also moot.
1134. For the reasons set out in the First Consolidated Plea, all three methodologies are inevitably linked. The ROSC and RDCT lay down a mechanism to coordinate RAs in the Core CCR. Cost sharing of the RDCTs activated as a result of the ROSC and RDCT depends unavoidably on the latter methodologies: their outputs are a necessary input into the RDCTCS. Indeed, the RDCTCS can only be implemented once the relevant inputs into the RDCTCS, the main one being the XRAs, have been implemented by the RDCT and ROSC. Similarly, the RDCT and ROSC need a cost sharing mechanism in order to be implemented because of their very nature: when optimising RA coordination, RDCT and ROSC aim at minimising costs deriving from RAs. Regional RA coordination can only occur if an adequate cost sharing ensues and, *vice versa*, cost sharing of RAs can only occur once the RAs have taken place. This is duly illustrated by ACER in ACER Decision 33/2020 (ROSC)²³⁹.
1135. That is why its implementation timescale needs to be linked to their implementation timescale. All Core TSOs acknowledged this in Article 40 of All Core TSOs' RDCT Proposal²⁴⁰ and its Explanatory Document²⁴¹, in Article 40 of All Core TSOs' ROSC Proposal²⁴² and its Explanatory Document²⁴³. Also, Article 14(3) of All Core TSOs' RDCTCS Proposal required the RDCTCS to be conditional upon the regulatory approval of the ROSC and the RDCT. When linking the RDCTCS' implementation timescale to the implementation of the ROSC and the RDCT, ACER reproduced All Core TSOs' RDCTCS Proposal. This link was confirmed ACER Decision 33/2020 (ROSC, paragraphs 165 to 171) and paragraphs 112 to 114 of ACER Decision 35/2020 (RDCT, paragraphs 105 to 125).
1136. In this context, Appellant VI expressly acknowledged the need to link the RDCTCS' implementation timescale with the implementation of the ROSC and RDCT in its email correspondence to ACER during the consultation:

²³⁹ ACER Decision 33/2020, para 167: "*For example, a congestion on the border between Germany and Poland may be most efficiently resolved by involving downward redispatching of generating unit(s) in Germany and upward redispatching of generating unit(s) in Czech Republic. It is expected that this redispatching actions will involve some revenues for German TSOs and some costs for the Czech TSO. Naturally, the Czech TSO will only be willing to support solving the congestion on the border between Germany and Poland if the incurred costs will be shared with all involved TSOs based on the polluter-pays principle. It is thus impossible to expect that TSOs can fully coordinate remedial actions at regional level without having the certainty that the corresponding costs will be shared among all TSOs.*"

²⁴⁰ https://consultations.entsoe.eu/markets/article-76-so-regulation-core-rosc-methodology/supporting_documents/2019%20%20Core%20ROSC%20Methodology%20.pdf

²⁴¹ Annex 16 to the Defence, p. 21: "*The implementation of this methodology is dependent on a number of conditions: a. Regulatory approval of Redispatching and Countertrading cost-sharing methodology required by Article 74 of CACM Regulation; b. CSA methodology, according to Article 76 of SO GL Regulation, has been implemented and is in operation in the Core CCR.*"

²⁴² https://consultations.entsoe.eu/markets/article-76-so-regulation-core-rosc-methodology/supporting_documents/2019%20%20Core%20ROSC%20Methodology%20.pdf

²⁴³ Annex 22 to the Defence, p. 26: "*The Core ROSC Methodology shall be implemented in a consistent manner with the Core RD and CT Methodology and Core Cost Sharing Methodology.*"

“Besides, we would like to stress again that implementing the whole cost sharing methodology for the first version of ROSC implementation is too risky. 30 months is too short to implement an efficient invoicing process trusted by TSOs and therefore RTE advocates more flexibility in the wording of article 37.2.b to allow implementation of basic cost sharing instead of the full cost sharing methodology in this timeframe. RTE highlights that trust is needed in the cost sharing tooling since large amount of money will be transferred between TSOs and a lack of trust in that tooling will lead to numerous disputes. Furthermore, implementing a full cost-sharing methodology before the implementation of Core ROSC puts the cart before the horse. A full implementation of Core ROSC Methodology shall be done in order to properly apply the cost sharing methodology.”²⁴⁴ The email evidences that Appellant VI does not negate the need to link the RDCTCS’ implementation timescale with the ROSC’s timeline but instead expresses its concerns about (i) 30 months being, in its opinion, too short for the RDCTCS’ implementation timescale and (ii) implementing the RDCTCS prior to a full implementation of the ROSC.

1137. Appellant VI challenges a simultaneous implementation of the RDCTCS with the ROSC and advocates that the RDCTCS’ implementation should start after a full implementation of the said methodologies.
1138. A simultaneous implementation of the RDCTCS with the ROSC and RDCT is, however, indispensable to attain the objectives of Article 3(3) CACM, whilst ensuring compliance with Article 16 ER. Indeed, the RDCTCS can only be implemented once the relevant inputs into the RDCTCS, the main one being the XRAs, have been implemented by the RDCT and ROSC. Similarly, the RDCT and ROSC need a cost sharing mechanism in order to be implemented because of their very nature: when optimising RA coordination through an algorithm, RDCT and ROSC aim at minimising costs deriving from RAs. Regional RA coordination can only occur if an adequate cost sharing ensues and, *vice versa*, cost sharing of RAs can only occur once the RAs have taken place. This is duly illustrated by ACER with an example in ACER Decision 33/2020 (ROSC)²⁴⁵.
1139. As to Appellant VI’s opposition to a 30 month duration, it omits to mention that this duration relates to the first step of a two-step timescale of, respectively, 30 months (2 and a half years) and 54 months (4 and a half years).
1140. First of all, the 30 month duration corresponds with the first step of the implementation of all three methodologies. It is the first step of a two-step approach, which is necessary and suitable to attain the objectives of the applicable regulatory framework (CACM and ER).
1141. A full implementation of the ROSC, RDCT and RDCTCS is complex and challenging from a technological perspective in a CCR comprising 13 countries. That is the reason why All Core TSOs proposed a timescale of 55 months for their full implementation²⁴⁶: “Considering the different principles and the size of the Core region, this automatization will represent a challenge that should not be underestimated.” It is the reason why the ROSC, RDCT and Contested Decision’s RDCTCS foresee a proposed timescale of 54 months for their full implementation²⁴⁷. In the light of the long term for the full implementation of the ROSC, RDCT and RDCTCS – 4 and ½ years – the necessity to introduce regional RA coordination in order to foster an optimal relief of physical congestions, whilst minimizing costs and maximizing CZC available to the market - hence improving social welfare – calls for a step-wise approach whereby some parts of the methodologies will be implemented in a shorter term. This is especially true because regional

²⁴⁴ Annex A.2.4 to Appeal VI.

²⁴⁵ Para 167: “For example, a congestion on the border between Germany and Poland may be most efficiently resolved by involving downward redispatching of generating unit(s) in Germany and upward redispatching of generating unit(s) in Czech Republic. It is expected that this redispatching actions will involve some revenues for German TSOs and some costs for the Czech TSO. Naturally, the Czech TSO will only be willing to support solving the congestion on the border between Germany and Poland if the incurred costs will be shared with all involved TSOs based on the polluter-pays principle. It is thus impossible to expect that TSOs can fully coordinate remedial actions at regional level without having the certainty that the corresponding costs will be shared among all TSOs.”

²⁴⁶ Annex 22 to the Defence, p. 25.

²⁴⁷ Article 13 of the Contested Decision’s RDCTCS, Article 37 of the ROSC (Annex 1 to ACER Decision 33/2020) and Article 37 of the RDCT (Annex 1 to ACER Decision 35/2020). See also para 115 of ACER Decision 35/2020.

RA coordination plays a key role in the maximisation of CB capacities. Compliance with the general CACM principles of Article 16 ER requires an earlier, first-step implementation of regional RA coordination at DA level, even though the absence of ID coordination could create some inefficiency, as acknowledged by ACER²⁴⁸. Indeed, the implementation of the ROSC, RDCT and RDCTCS is crucial to ensure due implementation of Articles 16(4) and 16(8) ER. RDCTs are used to maximize available capacities to reach the minimum 70%-threshold of Article 16(8) ER and a coordinated, non-discriminatory XRA process is used to enable this maximisation following the implementation of the RDCTCS, in accordance with Article 16(4) ER. Postponing the maximisation of CZC according to the ER until 4 June 2025 (54 months to await a full implementation of the methodologies) would be disproportionate to attain the objectives of the applicable regulatory framework. This is why a first-step implementation, initiating the gradual coordination process immediately as of the adoption of the ROSC and RDCT, was necessary and suitable.

1142. In addition, the need for an earlier implementation was expressly requested by All Core TSOs in the Explanatory Document to their ROSC Proposal²⁴⁹.
1143. The proposed timescale of 30 months as of the date of adoption of the ROSC and RDCT for the first step of the implementation of all three methodologies is also proportionate with the objectives of the applicable regulatory framework. Indeed, the first implementation step merely contains a simplified version of the regional coordination of all three methodologies. It ensures the implementation of the DA CROSA, the implementation of cost sharing for DA CROSA pursuant to cost sharing methodology (RDCTCS) and the inclusion of at least optimisation of RD resources and phase shifting transformers in RAO for DA CROSA (it may include some additional simplified processes of the ROSC or RDCT)²⁵⁰. When setting the 30 month duration, ACER correctly balanced any drawbacks caused by the length (30 months) of the first step of the implementation against the regulatory benefits of this first step, simplified coordination at DA level to attain the objectives of the applicable regulatory framework, including CZC maximisation. A term of 30 months is reasonable to ensure cost sharing of a simplified regional coordination, limited to a less demanding and challenging RA coordination at DA level. As set out by ACER during a presentation, a timescale of 30 months is standard for methodologies of similar or higher complexity, e.g. the aFRR and mFRR balancing platforms²⁵¹. Furthermore, All Core TSOs' request for a first-step interim solution in the Explanatory Document to their ROSC Proposal foresaw a shorter duration, of 24 months²⁵². Another example, put forward by ACER in its Rejoinder²⁵³, is the implementation of the "Transparency Platform"²⁵⁴, which only took 12 months and required highly complex IT tools to enable ENTSO-E and TSOs to meet their transparency obligations (such as data

²⁴⁸ Para 114 of ACER Decision 35/2020 (RDCT): "In case of under-estimation of congestions, however, it is possible that the remedial actions calculated at day-ahead timeframe will not be enough and additional cross-border relevant remedial actions will need to be ordered in intraday for which no cost sharing will apply. However, ACER emphasised that the interim solution with coordination at day-ahead level is still a significant improvement of the status quo, where no regional coordination exists. In ACER's view, the proposed gradual implementation with an interim (although imperfect) target would still provide the majority of the expected benefits much earlier (i.e. within 30 months) and therefore outweighs the alternative of one step implementation with the final target which can only be achieved within 54 months after the adoption of this RDCT Methodology."

²⁴⁹ Annex 22 to the Defence, p. 25: "Nevertheless, considering the importance to improve the efficiency of the coordination at regional level, Core TSOs and Core RSCs are aware and convinced that they cannot wait for the full implementation of the target situation. This is the reason why they also engage themselves to define and develop a step-wise approach considering interim solutions in a more ambitious but still realistic timing (...)."

²⁵⁰ Article 37(2) and (3) of the ROSC (ACER Decision 33/2020) and Article 37(2) and (3) of the RDCT (ACER Decision 35/2020).

²⁵¹ Annex A.3.6 to Appeal VI.

²⁵² Annex A.3.7 to Appeal VI.

²⁵³ Rejoinder, para 50.

²⁵⁴ Annex 104 to the Rejoinder.

about power consumption, balancing, outages, congestion management and system operations) pursuant to Art. 3 Commission Regulation (EU) No 543/2013 of 14 June 2013 on submission and publication of data in electricity markets and amending Annex 1 to Regulation (EC) No 714/2009 of the European Parliament and of the Council. Also, during the consultation process with ACER October 2020, Appellant VI proposed a first-step interim solution, which also foresaw a 30-months duration²⁵⁵.

1144. The proportionality of the 30-months duration is confirmed by Annex 103 to ACER's Rejoinder, entitled "*Core TSOs' Implementation Plan for Core ROSC, CACM 35 and 74 methodologies*" of 4 April 2021, which contains an implementation roadmap submitted by Core TSOs to Core NRAs. As set out by ACER's Rejoinder, this roadmap "*places critical dependencies in the implementation timescale to ROSC Methodology, whose implementation is much more complex and challenging than the RDCTCS Methodology. The Implementation roadmap does not indicate that implementation delays would be stipulated by the complexities in the implementation of RDCTCS Methodology.*"²⁵⁶
1145. Appellant VI claims that the 30 month duration is disproportionate because it fails to take account of the financial risks of implementing RDCTCS and of the likelihood of disputes between Core TSOs. The extensive bottom-up decision-making process evidences, however, that ACER was aware of the intrinsic financial consequences of the introduction of a cost sharing methodology and duly took them into account when adopting the Contested Decision.
1146. With respect to the financial consequences of the first step implementation of the RDCTCS, Article 12 of the Contested Decision's RDCTCS requires All Core TSOs to perform an annual review of methodology in order to identify possible improvements in, *inter alia*, "*the effectiveness of this cost sharing methodology in terms of (i) reasonable financial planning*"; and (ii) *providing correct incentives for managing congestions in an efficient way, including reconfiguration of bidding zones and capacity calculation as well as incentives for network investments*" and to develop and submit to All Core NRAs in parallel a proposal for amendment of the RDCTCS "*within twelve months of the implementation of the cost sharing methodology*". As set out in para 154 of the Contested Decision, this allows All Core TSOs to gain sufficient understanding and information about the appropriateness of all the aspects of the cost sharing solution based on real data.
1147. Regarding the likelihood of disputes between All Core TSOs, ACER introduced an obligation to appoint a "settlement entity", responsible to settle the costs among All Core TSOs in Article 8 of the Contested Decision's RDCTCS.
1148. Finally, Appellant VI claims that ACER should have expressly set out in the Contested Decision (i) the reasoning behind the starting and end date of the proposed implementation and (ii) the reasoning for not adhering to Appellant VI's interim solution that the latter presented at a meeting between ACER, CRE and RTE on 26 October 2020²⁵⁷.
1149. The Contested Decision sets out the reasoning for linking the RDCTCS' implementation timescale to the ROSC and the RDCT in a clear and unequivocal manner in paragraphs 155 to 158 referred to above. The reasoning for the starting and end date of the ROSC and RDCT are extensively explained in ACER Decision 33/2020 (paragraphs 165-171) and ACER Decision 35/3030 (paragraphs 105-125). It would not have been possible and was not necessary for ACER to fully reproduce this reasoning in the text of the Contested Decision. The stakeholders during the RDCTCS, ROSC and RDCT decision-making processes, including Appellant VI, are identical. The same Core TSOs and NRAs involved in the consultations on the RDCTCS were also involved in the consultations on the ROSC and RDCT, including Appellant VI. Hence, requiring a replication of the full reasoning of the ROSC and RDCT in the Contested Decision due to its linkage with the RDCTCS was neither necessary nor suitable, even more in the light of Appellant VI's detailed plea, which demonstrates that Appellant VI clearly and unequivocally understood the underlying reasoning of the Contested

²⁵⁵ Annex 22 to the Defence, p. 25.

²⁵⁶ Rejoinder, para 50.

²⁵⁷ Annex A.3.7 to Appeal VI.

Decision's timescale. Appellant VI's Plea provides a detailed reiteration of the arguments that it provided throughout the proceedings leading-up to the Contested Decision and expresses its dissatisfaction with the duly stated reasons set out in the Contested Decision. This evidences that ACER provided Appellant VI with a clear and unequivocal reasoning, which it was able to understand and is now able to rebut, even though it is dissatisfied with its content.

1150. Appellant VI's claim requiring an express mentioning of its proposed interim solution equally ties-in to its claim for a full replication of the reasoning behind the ROSC and RDCT in the Contested Decision. Regardless of the practical impossibility for the Agency to fully reproduce all the steps of the bottom-up decision-making process - which per definition implies a constant sharing of proposals and amendments between all stakeholders - in the body of its decisions, Appellant VI's interim solution is extensively set out in paragraphs 170 and 171 of ACER Decision 33/2020 (ROSC) and paragraphs 112 to 114 of ACER Decision 35/2020 (RDCT).
1151. Moreover ACER duly took account of Appellant VI's interim solution. Appellant VI's interim solution wanted to (i) delete the requirement to implement the RDCTCS implementation in the then available draft RDCTCS decision of 23 October 2020²⁵⁸ and to (ii) include a simplified version of the RDCTCS to complement the first-step 30 month implementation of the ROSC and RDCT as follows: *"a basic cost sharing with a minimum requirement to implement the existing cost sharing processes between TSOs, based on bilateral contracts"* and *"it could be mentioned that an initial version of the CACM 74 cost sharing methodology must be implemented as a parallel run process but that cannot enter into force until all the robust IT and invoicing requirements are met"*²⁵⁹. This proposal was, however, not submitted as All Core TSOs' Proposal. Regardless of the contents of the proposal, given (i) the lack of a demonstrated adherence or All Core TSOs to the Proposal, (ii) the timing of the submission of Appellant VI's submission - at the very end of the consultation process, on 26 October 2020, i.e. after ACER's 6 month deadline had already expired to take the Contested Decision and when a second draft decision still needed to go through AEWG and BoR approvals (the 95th BoR meeting was scheduled for 18 November 2020, as set out in the Eighteenth Consolidated Plea) - and (iii) the earlier delays that had arisen due to Core TSOs' inability to agree (All Core TSOs were unable to submit their proposal by the deadline of 17 May 2018 and submitted it almost a year later than the regulatory required date²⁶⁰), ACER rightly had no grounds to consider that All Core TSOs could agree on a provisional cost sharing solution to complement the first step of the implementation of the ROSC and RDCT, as is expressly set out in paragraphs 170 and 171 of ACER Decision 33/2020 (ROSC).
1152. **It follows that the Tenth Consolidated Plea must be dismissed as unfounded.**
1153. Appellants' claims on an infringement of the principle of proportionality are dealt with in the Eleventh Consolidated Plea

Eleventh Consolidated Plea – Principle of proportionality.

1154. The principle of proportionality is a general principle of EU law. Article 5(4) TEU provides that *"under the principle of proportionality, the content and form of Union action shall not exceed what is necessary to achieve the objectives of the Treaties."* and Recital (45) of the ACER Regulation states: *"In accordance with the principle of proportionality, as set out in that Article, this Regulation does not go beyond what is necessary in order to achieve those objectives."* Also, the CACM expressly highlights in Recital (32) that its rules are proportionate. Recital (74) ER states: *"Since the objective of this Regulation, namely the provision of a harmonised framework for cross-border exchanges of electricity, cannot be sufficiently achieved by the Member States but can rather, by reason of its scale and effects, be better achieved at Union level, the Union may adopt measures, in accordance with the principle of subsidiarity, as set out in Article 5 of the Treaty on European Union. In accordance with the principle of*

²⁵⁸ Annex A.2.8 to Appeal VI.

²⁵⁹ Annex A.2.8 to Appeal VI.

²⁶⁰ Contested Decision, para 6.

proportionality, as set out in that Article, this Regulation does not go beyond what is necessary in order to achieve that objective.”

1155. In line with the Board of Appeal’s consistent decision-making practice, ACER is bound by the general principles of EU Law, including the principle of proportionality²⁶¹.

1156. The main objectives of the CACM are:

“(a) promoting effective competition in the generation, trading and supply of electricity; (b) ensuring optimal use of the transmission infrastructure; (c) ensuring operational security; (d) optimising the calculation and allocation of cross-zonal capacity; (e) ensuring fair and non-discriminatory treatment of TSOs, NEMOs, the Agency, regulatory authorities and market participants; (f) ensuring and enhancing the transparency and reliability of information; (g) contributing to the efficient long-term operation and development of the electricity transmission system and electricity sector in the Union; (h) respecting the need for a fair and orderly market and fair and orderly price formation; (i) creating a level playing field for NEMOs; (j) providing non-discriminatory access to cross-zonal capacity.”²⁶².

1157. The objectives of the CACM are highlighted in Recital 1(1) CACM:

“The urgent completion of a fully functioning and interconnected internal energy market is crucial to the objectives of maintaining security of energy supply, increasing competitiveness and ensuring that all consumers can purchase energy at affordable prices. A well-functioning internal market in electricity should provide producers with appropriate incentives for investing in new power generation, including in electricity from renewable energy sources, paying special attention to the most isolated Member States and regions in the Union’s energy market. A well-functioning market should also provide consumers with adequate measures to promote more efficient use of energy, which presupposes a secure supply of energy.”

1158. Article 1(1) ER states that the ER aims to

“(a) set the basis for an efficient achievement of the objectives of the Energy Union and in particular the climate and energy framework for 2030 by enabling market signals to be delivered for increased efficiency, higher share of renewable energy sources, security of supply, flexibility, sustainability, decarbonisation and innovation”;

(b) set fundamental principles for well-functioning, integrated electricity markets, which allow all resource providers and electricity customers non-discriminatory market access, empower consumers, ensure competitiveness on the global market as well as demand response, energy storage and energy efficiency, and facilitate aggregation of distributed demand and supply, and enable market and sectoral integration and market-based remuneration of electricity generated from renewable sources;

(c) set fair rules for cross-border exchanges in electricity, thus enhancing competition within the internal market for electricity, taking into account the particular characteristics of national and regional markets, including the establishment of a compensation mechanism for cross-border flows of electricity, the setting of harmonised principles on cross-border transmission charges and the allocation of available capacities of interconnections between national transmission systems” and

“(d) facilitate the emergence of a well-functioning and transparent wholesale market, contributing to a high level of security of electricity supply, and provide for mechanisms to harmonise the rules for cross-border exchanges in electricity”.

1159. The Contested Decision’s RDCTCS was adopted upon joint request of the NRAs confirming their failure to reach an agreement and is a result of the gradual coordination and integration of the internal electricity market foreseen by the CACM and ER.

11.1 Definition of a new implementation timeline.

1160. Appellant VI²⁶³ claims that ACER breached the principle of proportionality when setting a 30 month duration for the proposed implementation timescale for the Contested Decision’s RDCTCS.

1161. In its Defence²⁶⁴, ACER responds that the 30 month duration was necessary and suitable to meet the objectives laid down in Article 3 CACM, specifically to ensure OS and to provide non-discriminatory access to CZC in DA. ACER highlights, in this respect, the urgency

²⁶¹ Board of Appeal Decisions A-001-2017, paras 69 and 114; A-002-2018, para 59; A-001-2019, paras 43, 56, 233-239; A-003-2019, para 149; A-006-2019, paras 41 and 47; A-001-2020, paras 240, 252 and 263; A-002-2020, paras 241, 253 and 264; A-003-2020, para 206 and 235; A-007-2020, paras 66 and 99 and A-008-2020, paras 292-302.

²⁶² Article 3 of the CACM.

²⁶³ Appeal VI, Plea 6, paras 242-267.

²⁶⁴ Defence, paras 745-780.

expressed by various stakeholders during the public consultation of the ROSC and RDCT²⁶⁵, referred to in Annex II to the ROSC and Annex II to the RDCT. It also stresses All Core TSOs' historic difficulty to reach an agreement on cost sharing.

1162. As set out above in the Tenth Consolidated Plea, the 30 month duration amounts to the first step of the proposed implementation timescale of the Contested Decision's RDCTCS, the second step adding an additional 24 months to the first step.
1163. It goes without saying that the CACM's objective of regional coordination cannot be achieved if methodologies are created without implementation timescales and with, in their stead, mere possibilities to amend them in future. As has been set out in detail in the Ninth and Tenth Consolidated Pleas, this would trigger insurmountable chains of deadlock situations and jeopardise any methodology's *effet utile*.
1164. The Contested Decision's RDCTCS does not exceed what is necessary to achieve the CACM's objective and is suitable to achieve that objective. Indeed, the Contested Decision's RDCTCS could not have ensured compliance with the Article 9(9) CACM in the absence of a proposed implementation timescale. This would also have jeopardised the *effet utile* of Article 9(13) CACM, which allows for amendments to the RDCTCS through a bottom-up decision-making process taking stock of the experience gained during the initial implementation of the methodology. As has been set out in the Ninth and Tenth Consolidated Pleas, the proposed implementation timescale is not only necessary but suitable to attain the objectives of the applicable regulatory framework.
1165. As set out in the Tenth Consolidated Plea, linking the implementation of the RDCTCS to the implementation of the ROSC (ACER Decision 33/2020) and the implementation of the RDCT (ACER Decision 35/2020) and providing for a simultaneous implementation of the ROSC and RDCT is equally necessary and suitable to attain the objectives of the applicable regulatory framework.
1166. Furthermore, the two-step approach, with a first step starting as of the adoption of the ROSC and the RDCT and lasting 2 years and a half (30 months) has also been shown to be necessary and suitable to attain the objectives of the applicable regulatory framework, as set out in Tenth Plea. Furthermore, the 30 months duration, which Appellant VI now challenges, corresponds with the 30 months duration of the first step interim solution that Appellant VI tabled during the consultation process leading-up to the Contested Decision²⁶⁶.

11.2 RDCTCS scope.

1167. Appellant III²⁶⁷ claims that the RDCTCS scope beyond the inclusion of interconnectors infringes the principle of proportionality. It holds that the RDCTCS should be proportionate to the aim of the ER, which is to foster CB exchanges in electricity. It refers to Recital (74) ER. Appellant III holds that interconnector capacities should not be limited by internal network congestions and that this is already sufficiently done in the course of mapping.
1168. Appellant IV²⁶⁸ claims that the excessive scope of the RDCTCS infringes the principle of proportionality because it over-penalises LFs.
1169. In its Defence²⁶⁹, ACER responds that the Contested Decision's RDCTCS scope is in accordance with the principle of proportionality because it was necessary to achieve the goals of the CACM and the ER.
1170. As set out above in the First Consolidated Plea, defining the scope of the Contested Decision's RDCTCS as including XNEs, in accordance with the ROSC and RDCT at Core level and CSAM at EU level, was not only necessary but also suitable to ensure compliance

²⁶⁵ Annex II to ACER Decision 35/2020 (ROSC) and Annex II to ACER Decision 33/2020 (RDCT).

²⁶⁶ Annex A.3.7 to Appeal VI.

²⁶⁷ Appeal III, Plea 1, paras 26-125.

²⁶⁸ Appeal IV, Plea 1, paras 29-65.

²⁶⁹ Defence, paras 242-244 and 249.

with the applicable regulatory framework foreseen by both the CACM and the ER. A narrower scope, which would consider only a sub-set of the scope of XNEs of Article 5 ROSC/Article 3 RDCT, regardless of its nature (be it interconnectors, CNECs or any other sub-set), would not only infringe Article 74(2) CACM, but also undermine cost sharing under the RDCTCS, as well as a correct functioning of the ROSC and RDCT and would even negatively affect efficient overall CACM in the Core CCR, in violation of Article 16 ER. The CACM and ER objectives of cost sharing of RA coordination, and of coordination RAs *per se* would not be attained, as set out in Sub-plea 1.1.7 of the First Consolidated Plea.

1171. Appellant II's claim²⁷⁰ that the scope of the RDCTCS should be narrowed down in order to reduce the penalisation of LFs is contrary to the CACM, which requires a cost sharing solution for XNEs, and the ER, which requires due application of the PPP when sharing costs among TSOs in relation to burdening LFs. By removing internal XNEs from the scope of the RDCTCS, TSOs causing burdening LFs that congest those internal XNEs would not be accountable under the PPP and a situation of free-riding would be created.
1172. The Contested Decision's RDCTCS does not exceed what is necessary to achieve the CACM's objective and is suitable to achieve that objective. Indeed, the Contested Decision's RDCTCS could not have ensured compliance with Articles 74 CACM and 16 ER had it not defined the scope of the RDCTCS in accordance with the scope of Article 5 ROSC/Article 5 RDCT.

11.3 Netting of flow components.

1173. Appellant IV²⁷¹ claims that the absence of netting infringes the principle of proportionality because it over-penalises LFs.
1174. As has been set out in detail in the Fifth Consolidated Plea, Article 7(6) of the Contested Decision's RDCTCS contains a netting process with respect to the calculation of the overload but does not contain an additional netting process for cost distribution. Contrary to Appellant IV's claim, the Contested Decision's RDCTCS does not imply an over-penalisation of Core TSOs causing LFs.
1175. The Board of Appeal finds that the Contested Decision's RDCTCS does not exceed what is necessary to achieve the CACM's objective and is suitable to achieve that objective.
1176. The Contested Decision's RDCTCS could not have ensured compliance with the Article 74 CACM if an additional netting process would have been introduced when allocating flow types to the overload. An additional netting process when allocating flow types to the overload would have infringed Article 16(13) ER and the PPP, as has been set in detail in the Fifth Consolidated Plea. It would have allowed some burdening LFs to escape the PPP even though they exceeded the legitimate LF threshold. This would have given wrong incentives to Core TSOs causing LFs not to take the necessary measures to reduce LFs in general (be they burdening or relieving).
1177. Not adding such process was not only necessary but also suitable to attain the objectives of the CACM and ensure compliance with the general CM principles of the ER. Not adding such additional netting process is in accordance with Article 16(13) ER and the PPP: costs are allocated to Core TSOs causing the congestion on the basis of the burdening flows for which they are responsible. Also, the absence of an additional netting process when allocating flows to the overload is fair and provides the correct incentives to TSOs: they are incentivised to reduce the creation of LFs by means of appropriate measures and network infrastructure investments.
1178. Also, the fact that there is netting of relieving and burdening flows when calculating the overload but no additional netting when allocating the distinct types of flows to the overload enhances the level of transparency and reliability of the information.

²⁷⁰ Appeal II, Plea 6, paras 122-150.

²⁷¹ Appeal IV, Plea 2, paras 75, 87 and 187-189.

11.4 Priority of loop flows above the threshold.

1179. Appellant II²⁷² claims that the proportionality principle has been infringed because the prioritization of LFs above the threshold was not appropriate and necessary to fulfil the legitimate objectives of the ER.
1180. Appellant IV²⁷³ claims that the priority of LFs above the threshold infringes the principle of proportionality because it over-penalises LFs.
1181. Appellant VI²⁷⁴ claims that the prioritization of LFs above the threshold infringes the principle of proportionality because it results in a burden on TSOs responsible for LFs that is not proportionate to their responsibility for the congestion volume. It claims that the absolute prioritization of LFs above the threshold is disproportionate and that a partial prioritization of IFs would have been more proportionate. Appellant VI claims that ACER was duly alerted of the risk of discrimination between LFs and IFs in case of an absolute prioritization of LFs above the threshold because it had submitted a separate analysis (building on Core TSOs' RDCT Experimentation) to ACER on 1 July 2020²⁷⁵, which showed that IFs are the main drivers of congestions in Germany and some other Central European BZs in comparison to the volume of burdening LFs. Appellant VI adds that IFs can even come close to the thermal capacity of the NEs, in which case LFs are overloaded and TSOs causing LFs will, as a consequence, pay for most of the RDCT costs, even when they are a limited contributor to the congestions compared to IFs. Appellant VI advocates that a partial prioritization of IFs (i.e. a prioritization of 25% or 50% of the IFs) would be more in line with their contribution to congestions in terms of volume. Appellant VI claims that this was recognised by ACER in an email of 9 September 2020²⁷⁶.
1182. The Board of Appeal finds that the Contested Decision's RDCTCS does not exceed what is necessary to achieve the CACM's objective and is suitable to achieve that objective.
1183. The Contested Decision's RDCTCS could not have ensured compliance with the Article 74 CACM and 16 ER without the prioritisation of LFs above the threshold.
1184. LF prioritisation was not only necessary but also suitable to attain the objectives set by the CACM and the ER. As set out in the Sixth Consolidated Plea, Sub-Plea 6.3, LF prioritisation is required to ensure compliance with the PPP and Article 16(13) ER. As set out in Sub-Pleas 6.6 and 6.8, it creates the correct incentives to manage congestion and fosters the efficient development and operation of the EU interconnected system and electricity market in the long term (Article 74(6)(a) and (e) CACM). As set out in Sub-Plea 6.9, it is consistent with the responsibilities and liabilities of Core TSOs (Article 74(6)(b) CACM). As set out in Sub-Plea 6.10, it ensures a fair distribution of costs and benefits between Core TSOs (Article 74(6)(c) CACM). As set out in Sub-Plea 6.13, it facilitates adherence to the general principles of CM (Article 74(6)(f) CACM). Finally, as set out in the Twelfth Consolidated Plea, it complies with the principles of transparency and non-discrimination (Article 74(6)(i) CACM and Article 16(1) ER).
1185. Appellant VI provides evidence of a separate analysis that Appellant VI conducted, building on All TSOs' Core RDCTCS Experimentation Report, which shows that (i) IFs are the main drivers of the congestions in Germany and other Central European BZs in comparison to the volume of burdening LFs and (ii) IFs can even come close to the thermal capacity of the NEs.

²⁷² Appeal II, Plea 4, paras 85-106.

²⁷³ Appeal IV, Plea 5, paras 187-189.

²⁷⁴ Appeal VI, Plea 4, paras 194-208.

²⁷⁵ Annex A.2.12 to Appeal VI.

²⁷⁶ Annex A.2.2 of Appeal VI.

Table 1 - Average share of internal and burdening loop flows in volume (% thermal capacity) on overloaded internal network elements

Average share of internal and burdening loop flows in volume (% thermal capacity) on overloaded internal network elements		
	Internal Flows	Total Loop Flows
Czech Rep.	51%	5.3%
Germany	65%	4.8%
Austria	30%	15.4%

Table 2 - Internal Flows (% thermal capacity) in the 10% worst cases on overloaded internal network elements

	Internal Flows (% thermal capacity) in the 10% worst cases on overloaded internal network elements
Czech Rep.	67%
Germany	89%
Nederland	66%
Poland	92%

Source: Appeal of Appellant VI, paragraphs 196 and 197.

1186. The Board of Appeal refers to the Sixth Consolidated Plea, Sub-Plea 6.3, above. LF prioritisation duly reflects the fact that LFs above the threshold are the primary contributors to the congestion on internal NEs. This is not a quantitative criterion but a qualitative criterion.
1187. Appellant VI advocates that a partial prioritization of IFs (i.e. a prioritization of 25% or 50% of the IFs), cost sharing between TSOs responsible for IFs and LFs would be more in line with their contribution to congestions in terms of volume. In its view, placing IFs as no.2 of the priority is discriminatory and penalises LFs in such a way that it puts a financial burden on some TSOs at the expense of others. Appellant VI illustrates this with an example:

Figure 2 - Prioritisation of loop flows compared to internal flows is discriminatory

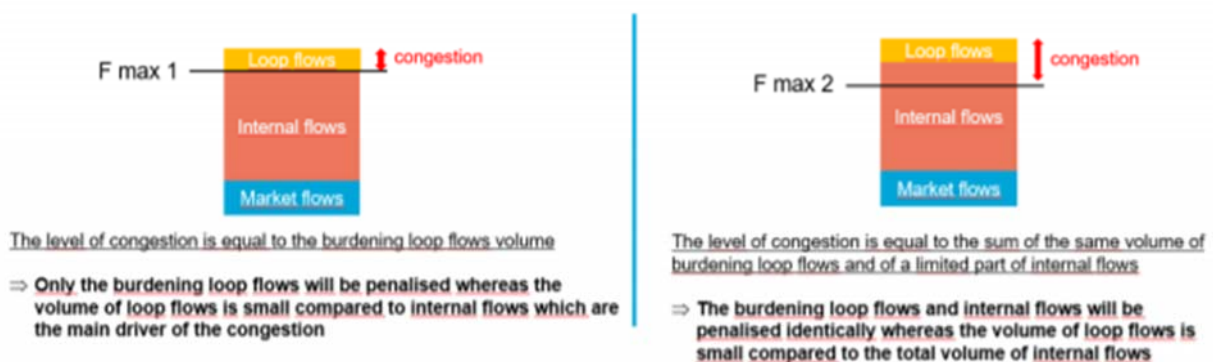

Source: Appeal of Appellant VI, paragraph 198.

1188. The Board of Appeal refers to the Twelfth Consolidated Plea, Sub-Plea 12.2, which sets out that placing IFs as no. 2 of the priority list is not discriminatory but that, conversely, an equal treatment of LFs above the threshold and IFs (placing both flows as no. 1 of the priority list) is discriminatory because of the unequal nature of LFs and IFs.
1189. Appellant VI also advocates that, with a partial prioritization of IFs (i.e. a prioritization of 25% or 50% of the IFs), cost sharing between TSOs responsible for IFs and LFs would be

more in line with their contribution to congestions in terms of volume. It illustrates this with extracts of All TSOs' Core RDCTCS Experimentation Report, as follows:

a. Case 1: Time Stamp 2018 11 21 on the overloaded German internal elements labelled D2YRHE11 - D2DOEW17

		Cost sharing (%)		
	Polluter Flows (% of internal+loop flows)	Loop flows are prioritized first	25% of internal flows are prioritised at the same level as loop flows	50% of internal flows are prioritised at the same level as loop flows
Internal flow	63%	0%	37%	54%
Dutch Loop Flow	37%	100%	63%	46%

b. Case 2: Time Stamp 2018 11 30 on the overloaded German internal elements labelled DDA_MA21 - D4DAXL21

		Cost sharing (%)		
	Polluter Flows (% of internal+loop flows)	Loop flows are prioritized first	25% of internal flows are prioritised at the same level as loop flows	50% of internal flows are prioritised at the same level as loop flows
Internal flow	55%	0%	42%	59%
French Loop Flow	38%	100%	58%	41%
Loop Flows from other BZ	8%	0%	0%	0%

Source: Appeal of Appellant VI, paragraph 199.

1190. According to Appellant VI, the above-mentioned extracts of All Core TSOs' RDCTCS Experimentation Report demonstrate that an absolute LF prioritisation leads to a disproportionate burden on some TSOs, even if they are limited contributors to the congestion. Appellant VI also alleges that the extracts demonstrate that a partial prioritisation of 25% or 50% IFs as no.1 of the priority list, alongside LFs above the threshold, would lead to a more balanced situation.
1191. The Board of Appeal notes that this claim contradicts Appellant VI's earlier claim, responded to in Sub-Plea 6.16, according to which ACER should not have used the results of All Core TSOs' RDCTCS Experimentation Report because of its deficiencies.
1192. The Board of Appeal refers to the Sixth Consolidated Plea, in particular Sub-Pleas 6.3, 6.4 and 6.16. Sub-Plea 6.16, which evidence that ACER carried out a rigorous analysis. ACER carried out own simulations, which were based on All Core TSOs' Experimentation Report but included specific parameters aimed at addressing the concerns that All Core NRAs and All Core TSOs had conveyed to ACER during the consultation. When carrying out its own simulations, ACER simulated the results of other scenarios (by modifying the parameters of this same model) in order to (i) carefully evaluate the different arguments from Core TSOs and NRAs and (ii) investigate alternative options that were compliant with Articles 74 CACM and 16 ER.
1193. Sub-Plea 6.16 evidences that ACER assessed various alternative scenarios to LF prioritisation in combination with a 10%-LF threshold. The Board of Appeal notes that scenario ACER SCEN.7 considered a scenario that combined a 15% LF threshold with the placement of 25% IFs as no.1 of the priority list, alongside LFs above the threshold. Consequently, ACER took the Contested Decision after a careful review of a variety of IF prioritisation possibilities. It took account of this rigorous analysis when deciding that LF prioritisation was not only necessary but also suitable to attain the objectives set by the CACM and the ER.

1194. Regarding the email correspondence cited by Appellant VI, the Board of Appeal highlights that the decision-making process leading-up to the Contested Decision is a bottom-up decision-making process, whereby all stakeholders involved exchange opinions and provide input to attain an optimal solution that ensures compliance with the applicable regulatory framework. This is in accordance with the Board of Appeal's earlier case-law²⁷⁷.
1195. Appellant VI alleges that the disproportionate burden on some TSOs, caused by the LF prioritisation, is further strengthened by the absence of netting between burdening and relieving flows.
1196. The Board of Appeal refers to the Fifth Consolidated Plea with respect to netting.
1197. The Contested Decision contains an implicit netting process with respect to the calculation of the total flow on each NE facing congestion in order to calculate its overload. It does not contain any additional netting of LFS for the cost distribution process among Core BZs, given that this would not ensure compliance with the applicable regulatory framework.
1198. In particular, Sub-Plea 5.6 explains that an additional netting process for the cost allocation under the Contested Decision's RDCTCS would alter the priority stack of flow components. As set out by ACER in its Rejoinder²⁷⁸, in case an additional netting solution for the cost allocation were to be applied, it is not automatically given that relieving LFs would net burdening LFs of other BZs; they could also relieve IFs, PST flows or AFs. Therefore, a trade-off would be necessary in order to decide which burdening type of flows is to be netted. There is no legal provision or law of physics that would require granting priority in netting to LFs over other flows, *i.e.*, IFs, PST flows, AFs. Deciding that relieving LFs from a BZ would net burdening LFs from another BZ would imply a different priority of flows than the one applied for identifying the contribution to congestion.
1199. Appellant VI also refers to its financial assessment for France, included as Confidential Annex A.6 to its appeal, which is based on All Core TSOs' RDCTCS Experimentation Report. Appellant VI claims that LF prioritisation leads to a disproportionately heavy financial burden for France and Appellant VI²⁷⁹.
1200. Confidential Annex A.6 to Appellant VI's appeal includes a financial assessment of cost sharing for France under 3 options ("*Option 1 - ACER proposal : Threshold on LF set to 10%; Option 2 - ACER initial compromise in July: Threshold on LF set to 15% + partial prioritisation of IF (25%); and Option 3 - Initial proposal of RTE/CRE: Threshold on LF+IF set to 20% + partial prioritisation of IF (50%)*"). For each of these options, Appellant VI considered 3 different scenarios, namely a low reference case scenario, a standard risk scenario as well as an extreme risk scenario.
1201. The Board of Appeal refers to the Sixth Consolidated Plea, which sets out in detail the rationale for stacking LFs above the threshold as no.1 of the priority list and why including IFs in the no.1 stack of the priority list would be unlawful. Hence, the solution proposed by Appellant VI does not constitute an alternative solution that ensures compliance with the applicable regulatory framework.
1202. In a subsidiary fashion, the Board of Appeal notes that both the Appeal and its Confidential Annex A.6 acknowledge that the financial assessment is not robust but amounts to a rough approximation: its elaboration was "*fraught with difficulties in the absence of any detailed, robust and reliable studies*" and "*the precise financial impact of the Methodology is uncertain and difficult to quantify without further studies*". The disclaimer to Annex A.6 states that: "*the data used to provide these results are based on the RDCT CORE experimentation. As identified by the TSOs in the report, both modelling and inputs have strong limitations; even if RTE has selected only the most robust data from the experimentation, the*

²⁷⁷ Board of Appeal Decisions A-004-2019, para 233; A-001-2020, paras 14, 102, 106, 138, 139, 160, 161, 184, 188, 234 and 258; A-002-2020, paras 14, 102, 106, 139, 140, 161, 162, 185, 189, 235 and 259; A-003-2020, para 14; A-007-2020, paras 5, 14, 68, 103 and 104; and A-008-2020, paras 19, 113-115, 138, 150, 153, 165, 167, 175, 188, 218, 239, 250, 290, 297 and 326.

²⁷⁸ Rejoinder, para 7.

²⁷⁹ A non-confidential version of Annex A.6 to Appeal VI has been provided by Appellant VI and shared among parties.

scope of the data is limited to 10 Time Stamps only; the analysis is based on historical data (2017-2019) although the European network will have changed when the cost sharing methodology will be implemented (RnW development, impact of action plans, impact of the 70% capacity requirement); all the following results are only indicative to provide a magnitude of the financial impacts for France based on strong assumptions; a larger set of experimentation is needed to provide robust results” and its conclusions contain an additional disclaimer: “Ces estimations restent indicatives du fait du jeu de données limité issu de l’expérimentation et ne peuvent être communiqués à l’ACER qu’en mentionnant toutes les limites et hypothèses”.

1203. Furthermore, the standard and extreme risk scenarios of the financial assessment are based on extreme assumptions, whereas the low reference case scenario appears to be closer to ACER’s Contested Decision.

1204. Regarding the option put forward by Appellant VI in its Appeal as likely resulting in a significantly lower financial burden for France and Appellant VI, it corresponds with option 2 of the financial assessment of Annex A.6 to its appeal. It involves a LF threshold of 15% combined with a partial prioritisation of IFs at 25% (“Appellant VI’s Alternative”). The Board of Appeal notes that Appellant VI’s Alternative was examined by ACER as ACER SCEN.7 when carrying out its own simulations during the process leading-up to the Contested Decision, as set out in the Sixth Consolidated Plea:

Table 7: Cost shares (in %) for coordinated RAs taken during 10 timestamps of All Core TSOs’ RDCTCS Experimentation Report for scenarios of ACER’s own simulations.

Scenario (%)	AT	BE	CZ	DE	FR	HR	HU	NL	PL	RO	SI	SK	TOTAL
GREEN	21,2%	0,3%	1,2%	68,9%	8,1%	-0,5%	0,0%	0,0%	0,9%	0,0%	-0,2%	0,2%	100,0%
GREEN SENSI 2	21,1%	0,4%	1,2%	69,8%	7,0%	-0,6%	0,1%	0,1%	1,0%	0,0%	-0,3%	0,2%	100,0%
GREEN SENSI 4	21,1%	0,3%	1,2%	66,7%	8,1%	-0,5%	0,0%	2,9%	0,3%	0,0%	-0,2%	0,2%	100,0%
YELLOW	21,5%	0,5%	-2,4%	57,9%	5,6%	-0,7%	0,2%	6,0%	11,2%	0,0%	-0,2%	0,4%	100,0%
BLUE	14,7%	1,4%	1,2%	56,5%	11,6%	1,3%	2,5%	3,6%	2,5%	1,2%	1,4%	2,0%	100,0%
ACER Scen. 1	22,6%	0,4%	1,2%	67,8%	6,5%	-0,5%	0,0%	0,9%	1,1%	0,0%	-0,2%	0,1%	100,0%
ACER Scen. 2	22,6%	0,4%	0,6%	64,3%	6,5%	-0,5%	0,0%	3,4%	2,7%	0,0%	-0,2%	0,1%	100,0%
ACER Scen. 3	22,6%	0,4%	0,8%	65,6%	6,5%	-0,5%	0,0%	2,6%	1,9%	0,0%	-0,2%	0,1%	100,0%
ACER Scen. 4	19,8%	0,5%	1,0%	69,5%	7,6%	-0,4%	0,0%	0,9%	1,0%	-0,1%	-0,1%	0,5%	100,0%
ACER Scen. 5	19,6%	0,5%	0,4%	65,3%	7,6%	-0,4%	0,0%	3,7%	3,0%	-0,1%	-0,1%	0,4%	100,0%
ACER Scen. 6	19,7%	0,5%	0,6%	66,7%	7,6%	-0,4%	0,0%	2,9%	2,1%	-0,1%	-0,1%	0,5%	100,0%
ACER Scen. 7	21,3%	0,4%	1,0%	66,4%	7,7%	-0,5%	0,0%	2,1%	1,6%	0,0%	-0,1%	0,2%	100,0%
Average	20,6%	0,5%	0,7%	65,4%	7,5%	-0,4%	0,2%	2,4%	2,5%	0,1%	-0,1%	0,4%	100,0%
Minimum	14,7%	0,3%	-2,4%	56,5%	5,6%	-0,7%	0,0%	0,0%	0,3%	-0,1%	-0,3%	0,1%	100,0%
Maximum	22,6%	1,4%	1,2%	69,8%	11,6%	1,3%	2,5%	6,0%	11,2%	1,2%	1,4%	2,0%	100,0%

Source: Paragraph 102 of the Defence, referring to its Annexes 24 and 87.

1205. Table 7 demonstrates that, if iVBM mapping is used, the Contested Decision generates a cost share for France of 7.6%, whereas ACER SCEN.7/Appellant VI’s Alternative generates a cost share for France of 7.7%. I.e. the difference between the Contested Decision and Appellant VI’s Alternative consists of a small increase of 0.1%.

1206. However, as set out above in the Sixth Consolidated Plea, the scenarios of Table 7 are based on iVBM mapping. In August 2020, ACER performed new simulations for LCBM mapping, but only carried out new simulations for ACER SCEN.4 scenario, and not for ACER SCEN.7 scenario/Appellant VI’s Alternative. As shown in Table 8, the change from iVBM to LCBM generates a change for ACER SCEN.4 scenario from 7.6% to 1.8% in the French BZ.

Table 8: Cost shares (in %) for coordinated RAs taken during 10 timestamps of All Core TSOs’ RDCTCS Experimentation Report under ACER scenario 4, comparing iVBM mapping and LCBM mapping.

Mapping	AT	BE	CZ	DE	FR	HR	HU	NL	PL	RO	SI	SK	Sum
iVBM old	19,8%	0,5%	1,0%	69,5%	7,6%	-0,4%	0,0%	0,9%	1,0%	-0,1%	-0,1%	0,5%	100,0%
LCBM	11,9%	0,3%	17,1%	60,4%	1,8%	0,2%	0,0%	3,5%	4,3%	0,0%	0,0%	0,6%	100,0%

Source: Paragraphs 103 of the Defence, referring to its Annexes 24 and 87

Given that the change from iVCM to LCBM netting decreased France’s cost share from 7.6% to 1.8% as regards scenario ACER SCEN.4, it is not expected that a change from iVCM to LCBM will increase France’s cost share of 7.7% as regards ACER SCEN.7/Appellant VI’s Alternative, but rather that it will decrease this share.

1207. In the light of the above, it appears that ACER carefully considered the expected financial impact of the Contested Decision on Core TSOs and consumers and that the Contested Decision is necessary and suitable in relation to the objectives pursued.
1208. Appellant VI correctly acknowledges, in this respect, that *“the principle of proportionality does not require that ACER selects an option that has the lowest possible financial impact on any given TSO which relies on such principle, which would make any decision impossible.”*
1209. The Board of Appeal concludes that ACER’s Contested Decision is not invalidated by Appellant VI’s Alternative because it does not constitute an alternative solution that ensures compliance with the applicable regulatory framework and, subsidiarily, would, in any event, not represent a significant change regarding the French BZ’s cost share in comparison to the Contested Decision.

11.5 Threshold for acceptable loop flows.

1210. Appellant III²⁸⁰ claims that ACER should have considered an alternative, less invasive threshold value, taking account of national characteristics, to the common threshold value for acceptable LFs of 10%. The absence of doing so violates, in its opinion, the principle of proportionality.
1211. Appellant IV²⁸¹ claims that the common threshold for acceptable LFs of 10% infringes the principle of proportionality because it over-penalises LFs.
1212. Appellant V²⁸² claims that the adoption of a 10%-threshold in the absence of the technical analysis foreseen by Article 16(13) ER violates the principle of proportionality. The 10%-threshold is, in its view, not appropriate to attain the objective of the cost-sharing methodology pursuant to Article 74 CACM, which is to avoid undue discrimination between internal exchanges and CZ exchanges. Appellant V alleges that the European legislator considers a minimum capacity for CZ trade of 70% to be necessary but also proportionate and sufficient to avoid undue discrimination, as set out in ACER Decision 02/2019. Conversely, this means that up to 30% of the interconnection capacity is considered appropriate for other exchanges, especially LFs, and that a common LF threshold of 10% is neither necessary nor appropriate to avoid undue discrimination between internal exchanges and CZ exchanges.
1213. Appellant V adds that the fact that the 10%-threshold is only temporary does not affect the infringement of the principle of proportionality. In its opinion the fact that ACER sets a threshold as an interim solution, suggests that ACER was well aware that its solution was neither technically justified nor a lawful solution.
1214. In its Reply²⁸³, Appellant V adduces that the mere fact that a solution is only temporary does not mean that lower standards of proportionality apply and that, irrespective of the temporary character of a provision, only a technically profoundly reasoned determination can be an adequate basis to apply the PPP when the threshold is exceeded.
1215. The Board of Appeal finds that the Contested Decision’s RDCTCS does not exceed what is necessary to achieve the CACM’s objective and is suitable to achieve that objective.
1216. The Contested Decision’s RDCTCS could not have ensured compliance with the Article 74 CACM and Article 16(13) ER without a legitimate LF threshold. An adequate level of coordination in terms of RDCTs and OS can only be achieved through a corollary cost sharing system, as provided for in the RDCTCS and, as set out in the Fourteenth Consolidated Plea, Sub-Plea 14.2, a legitimate LF threshold is indispensable for the RDCTCS.
1217. Given that All Core TSOs’ RDCTCS Proposal did not contain a legitimate LF threshold as required by Article 16(13) ER, ACER had to ensure compliance with Article 16(13) ER as per Article 74(6)(f) CACM. It therefore asked All Core TSOs to set the legitimate LF threshold

²⁸⁰ Appeal III, Plea 2, para 153.

²⁸¹ Appeal IV, Plea 5, paras 187-189.

²⁸² Appeal V, Plea 3, paras 199-205.

²⁸³ Reply of Appellant V, para 250.

required by Article 16(13) ER in a 4 month deadline but, in the absence of compliance by All Core TSOs, it was under a duty to ensure compliance with Article 16(13) ER and therefore determined a temporary common threshold for legitimate LFs.

1218. In the absence of a threshold for legitimate LFs, the Contested Decision's RDCTCS could not have ensured compliance with the Article 74(6)(b) CACM, which requires the RDCTCS to "*be consistent with the responsibilities and liabilities of the TSOs involved*". All Core TSOs had the responsibility to determine a threshold for legitimate LFs. The absence of an agreement forced ACER to determine a temporary LF threshold that would disappear as soon as All Core TSOs would determine a definitive LF threshold (which All Core TSOs could do prior to the implementation of the RDCTCS in order to avoid that ACER's temporary LF threshold by used at all).
1171. In the absence of a threshold for legitimate LFs, the Contested Decision's RDCTCS could not have ensured compliance with Article 74(6)(e) CACM, requiring the RDCTCS to "*facilitate the efficient long-term development and operation of the pan-European interconnected system and the efficient operation of the pan-European electricity market*". Both the efficient long-term development and operation of the EU interconnected system and the efficient operation of the EU electricity market require that the costs of RDCT actions be shared at a regional level among TSOs through a cost sharing solution. And a legitimate LF threshold is indispensable in order to create a RDCTCS in line with the PPP, as mandated by the ER.
1172. In the absence of a threshold for legitimate LFs, the Contested Decision's RDCTCS could not have ensured compliance with the Article 74(6)(f) CACM, which requires the RDCTCS to "*facilitate adherence to the general principles of congestion management as set out in Article 16 ER*". Article 16(13) ER expressly requires that a "*level*" is set below which structural congestion can be expected in a BZ. Given that All Core TSOs had not (yet) reached an agreement on the legitimate LF threshold, ACER was under a regulatory obligation to set a temporary LF threshold in order to ensure compliance with the CACM and the ER. The absence of the temporary LF threshold set by ACER would have thwarted the application of the PPP, at the heart of the cost sharing methodology of the RDCTCS. The PPP is at the heart of the cost sharing methodology of the RDCTCS²⁸⁴.
1173. The absence of the temporary LF threshold set by ACER would also have jeopardised the *effet utile* of Article 74 CACM, given that the threshold for legitimate LFs is as an indispensable part of the RDCTCS, as expressly recognised by the Contested Decision. Paragraph 109 of the Contested Decision states: "*The threshold for loop flows is an indispensable part of the cost sharing methodology, because Article 16(13) of the Electricity Regulation establishes a principle by which loop flows, which are expected in bidding zones without structural congestions should not be considered as contributing to congestion and therefore penalised. This principle reflects the fundamental nature of zonal electricity market model that even in an optimal bidding zone configuration, some levels of loop flows would still persist and are therefore inherent in any zonal market model. Article 16(13) of the Electricity Regulation therefore establishes a rule by which this normal level of loop flows is legitimate and should not be penalised.*"
1174. In the absence of ACER's determination of a temporary threshold for legitimate LFs, a deadlock situation could have occurred whereby the inability for All Core TSOs to reach an agreement could have led to the consequence that no adequate RDCTCS could have been implemented.
1175. ACER had two options when it faced a lack of compliance of All Core TSOs' RDCTCS Proposal with the requirements of Article 16(3) ER: either to specify a legitimate LF threshold itself or instead to require All Core TSOs propose to specify a legitimate LF threshold. ACER chose the latter, in line with the principle of proportionality, and asked All Core TSOs to specify a legitimate LF threshold within a 4-month deadline, which was reasonable to enable ACER to subsequently supervise its compliance with the applicable regulatory framework and approve it. However, in the absence of an agreement between All Core TSOs, ACER was under a duty to ensure that the RDCTCS complied with the applicable

²⁸⁴ See Contested Decision, para 109. See also, ACER's Defence, e.g. paras 447-448, 450, 462 and 467.

regulatory framework, including Article 16(13) ER and contained a legitimate LF threshold. It therefore determined a temporary common threshold for acceptable LFs in the amount of 10%, following a rigorous analysis of the results from All Core TSOs' Experimentation Report, All Core TSOs' Non-Paper, All Core NRAs' Non-Paper and the results from ACER's own simulations using a variety of parameters. The Contested Decision's RDCTCS clarifies that this threshold is temporary and will automatically be replaced by a new threshold commonly determined by All Core TSOs and approved by All Core NRAs. The Contested Decision's RDCTCS does not set any time restrictions upon Core TSOs and NRAs to adopt a definitive legitimate LF threshold replacing the temporary threshold of the Contested Decision's RDCTCS. This implies that All Core TSOs and NRAs could adopt a definitive legitimate LF threshold before the actual implementation of the RDCTCS and avoid the implementation of the temporary threshold all in all.

1176. In other terms, ACER left it up to All Core TSOs to determine the legitimate LF threshold but, in the absence of such timely determination, ensured an interim solution in order not to jeopardise the implementation of the RDCTCS and, what is more, the implementation of the interim solution could still be avoided by All Core TSOs as soon as they would agree on a definitive legitimate LF threshold to replace ACER's temporary threshold. All Core TSOs' could even agree to determine a legitimate LF threshold before the implementation of the RDCTCS in order to avoid any use of ACER's temporary threshold at all.
1219. Consequently, the determination of a LF threshold in the Contested Decision's RDCTCS is necessary and suitable to attain the objectives of the applicable regulatory framework.
1220. The fact that this threshold was determined in a 2-step LF approach, with a common 10% threshold subsequently split among individual BZs, is also necessary and suitable to attain the objectives of the applicable regulatory framework.
1221. As set out in the Seventh Consolidated Plea, the LF threshold has been set in accordance with a situation without structural congestion as required by Article 16(13) ER (Sub-Pleas 7.5 and 7.9, it does not imply over-penalisation as alleged by some Appellants). Furthermore, this determination was based on a robust technical analysis (Sub-Pleas 7.2, 7.3 and 7.15). The temporary nature of the threshold (Sub-Plea 7.1) underlines its compliance with the principle of proportionality given that Core TSOs and Core NRAs are able to remove it at any moment and replace it by a commonly agreed legitimate LF threshold upon an in-depth study. The Board notes that, since the adoption of the Contested Decision, no steps have been undertaken by Core TSOs to define a legitimate LF threshold²⁸⁵. Finally, the Board of Appeal refers to Sub-Plea 7.6 as regards the relationship between the 30%-cap of Article 16(8) ER and the 10%-threshold of the Contested Decision's RDCTCS, especially to the fact that, if the 30%-threshold were to amount to the applicable threshold for LFs, there would be no need for Article 16(13) ER to require such threshold, and even less to require TSOs to perform an in-depth study to set the threshold per BZ.

11.6 Cumulative effect of various infringements.

1222. Appellant IV²⁸⁶ claims that the various infringements of the principle of proportionality in Sub-Pleas 11.2, 11.3, 11.4 and 11.5 "*accumulate to more than the sum of their parts*". In Appellant IV's view, the RDCTCS' excessive scope enhances the over-penalisation of LF polluters due to the absence of netting, prioritisation of LFs above the threshold and common threshold for acceptable LFs of 10%. The RDCTCS scope encompasses, in its view, nearly all congested NEs in Core, which triggers a leverage effect on all the infringements and violations of EU law.

²⁸⁵ Replies to the Third Request for Information by the Board of Appeal of Appellants I, III, IV, V and VI.

²⁸⁶ Appeal IV, Plea 5, paras 187-189.

1223. Appellant VI²⁸⁷ claims that the impact of the disproportionate prioritization of LFs above the threshold is strengthened by the alleged absence of netting between the burdening and relieving LFs.
1224. In its Defence²⁸⁸, ACER responds that the scope of the NEs covered by the RDCTCS, the flows considered to be the source for costly RAs, the common LF threshold of 10%, the splitting process to determine individual thresholds per BZ and the prioritisation of LFs above the threshold are all in line with the principle of proportionality and that, consequently, there is no leverage effect.
1225. Having found no infringement of the principle of proportionality in Sub-Pleas 11.1, 11.2, 11.3, 11.4 and 11.5, the Board of Appeal does not identify a cumulative effect of infringements.
1226. **It follows that the Eleventh Consolidated Plea must be dismissed as unfounded.**
1227. Appellants' claims relating to an infringement of the duty to reason are dealt with in the Seventeenth Consolidated Plea.

Twelfth Consolidated Plea – Principle of non-discrimination.

1228. In line with the Board of Appeal's consistent decision-making practice, ACER is bound by the general principles of EU Law, including the principle of non-discrimination²⁸⁹.
1229. The principle of non-discrimination is laid down in Article 18 TFEU: "*Within the scope of application of the Treaties, and without prejudice to any special provisions contained therein, any discrimination on grounds of nationality shall be prohibited.*"
1230. It is also set out in Articles 20 and 21 of the Charter:
"Article 20 Equality before the law. Everyone is equal before the law.
Article 21 Non-discrimination 1. Any discrimination based on any ground such as sex, race, colour, ethnic or social origin, genetic features, language, religion or belief, political or any other opinion, membership of a national minority, property, birth, disability, age or sexual orientation shall be prohibited. 2. Within the scope of application of the Treaty establishing the European Community and of the Treaty on European Union, and without prejudice to the special provisions of those Treaties, any discrimination on grounds of nationality shall be prohibited."
1231. The principle of non-discrimination is also contained in the recitals of the ER and CACM.
1232. Article 74(6)(i) CACM requires the RDCTCS to "*comply with the principles of transparency and non-discrimination*".
1233. Article 3(e) CACM cites, as an objective of the CACM, "*ensuring fair and non-discriminatory treatment of TSOs, NEMOs, the Agency, regulatory authorities and market participants*".
1234. Article 16(1) ER states that "*network congestion problems shall be addressed with non-discriminatory market-based solutions which give efficient economic signals to the market participants and transmission system operators involved.*"
1235. Both the principle of equal treatment and the principle of non-discrimination require that comparable situations must not be treated differently and that different situations must not be treated equally, unless such treatment is objectively justified²⁹⁰.
1236. In order to categorise situations as similar or different, they must be considered in the light of the aims of the measure in question: whether the requirement that situations must be comparable for the purpose of determining whether there is a breach of the principle of equal treatment has been met must be assessed in the light of all the elements which characterise

²⁸⁷ Appeal VI, Plea 4, para 203.

²⁸⁸ Defence, paras 618-619.

²⁸⁹ Board of Appeal Decisions A-001-2017, paras 69 and 114; A-002-2018, para 59; A-001-2019, paras 43, 56, 233-239; A-003-2019, para 149; A-006-2019, paras 41 and 47; A-001-2020, paras 240, 252 and 263; A-002-2020, paras 241, 253 and 264; A-003-2020, para 206 and 235; A-007-2020, paras 66 and 99 and A-008-2020, paras 292-302.

²⁹⁰ Board of Appeal Decisions A-002-2018, paras 59-60; A-001-2019, para 159 and A-003-2019, para 90. See also Case C-390/15 RPO, ECLI:EU:C:2017:174, para 41 and C-336/19, Centraal Israëlitisch Consistorie van België e.a. ECLI:EU:C:2020:1031, para 85.

them and, in particular, in the light of the subject matter and purpose of the national legislation which makes the distinction at issue²⁹¹.

Discrimination occurs where one person is treated less favourably than another one in a comparable situation on account of a specific distinguishing characteristic or on account of another characteristic which, however, is strictly related to the specific distinguishing characteristic. In the case of discrimination on grounds of nationality, the distinguishing characteristic relates to nationality²⁹².

12.1 RDCTCS scope.

1237. Appellant III²⁹³, which differentiates between an illegal inclusion of internal NEs and internal CNEs in the RDCTCS scope, alleges that the RDCTCS discriminates, in both scenarios, against larger BZs, which naturally cause more LFs than smaller BZ. It explains that larger BZs such as Germany have a higher volume of LFs due to a high amount of renewable energies. In its view, the RDCTCS scope discriminates against BZs with a high share of renewable energy production (promoting the European climate targets) because it increases the already high financial burden put on end-consumers stemming from the fact that renewable energy requires high network expansion costs. Appellant III claims that those costs amount to a “two- to three-digit million EUR amount per year in Germany”.
1238. In its Defence²⁹⁴, ACER alleges that the Contested Decision’s RDCTCS does not discriminate against larger BZs with a high share of renewable energy production.
1239. Interveners II to VI support this stance. In their view, on the contrary, the exclusion of a subset of XNEs from the RDCTCS although these XNEs are included in the ROSC (optimisation through CROSA) would lead to an unjustified discrimination²⁹⁵. Disregarding LFs on some NEs would be similar to determining an infinite legitimate LF threshold on those XNEs, applying a full OPP to these NEs and carrying out a hidden transfer of costs from TSOs in BZs generating LFs towards TSOs in BZs hosting LF, owning the excluded XNEs.
1240. The Board of Appeal finds that the scope of the Contested Decision’s RDCTCS equally applies to all NEs of the Core region. Cost sharing in larger BZs does not differ from cost sharing in smaller BZs within the Core region and the coordination of RAs in large BZs does not differ from the coordination of RAs in small BZs. Consequently, larger BZs are not discriminated against by the Contested Decision’s RDCTCS.
1241. Moreover, applying RDCTCS to XNEs is precisely an instrument to avoid discrimination, as has been set out in Sub-Plea 1.1.7 of the First Consolidated Plea. Indeed, a narrower scope would imply that LFs on the smaller sub-set of XNEs (e.g. interconnectors) would contribute to cost sharing, whereas LFs of the same type on the excluded sub-set of XNEs (e.g. internal NEs) would not contribute to cost sharing.
1242. ACER’s Defence provides a table with the results of the scenarios of All Core TSOs’ RDCTCS Experimentation Report (GREEN, GREEN SENSI 2, GREEN SENSI 4, BLUE, YELLOW), ACER’s own simulations of August 2020 using LCBM mapping (ACER SCEN.4 August 2020) and ACER’s own simulations of March 2021 using LCBM mapping (ACER SCEN. 4 March 2021)²⁹⁶. The table demonstrates that a small BZ as Austria bears [10.8% to 21.5%] of the costs in the various scenarios whereas a large BZ as France bears [2% to 11.6%] of the costs in the various scenarios.

²⁹¹ Case C-193/17 Cresco Investigation, EU:C:2019:43, para 42; C-432/14 O, EU:C:2015:643, para 32 and C-451/16 MB, EU:C:2018:492, para 42.

²⁹² Board of Appeal Decisions A-001-2019, para 159 and A-003-2019. paras 90-100.

²⁹³ Appeal III, Plea 1, paras 25-125.

²⁹⁴ Defence, para 242.

²⁹⁵ Application for Interventions by Interveners II, III, IV, V and VI.

²⁹⁶ Defence, para 242.

Scenario (%)	AT	BE	CZ	DE	FR	HR	HU	NL	PL	RO	SI	SK	TOTAL
GREEN	21,2%	0,3%	1,2%	68,9%	8,1%	-0,5%	0,0%	0,0%	0,9%	0,0%	-0,2%	0,2%	100,0%
GREEN SENS1_2	21,1%	0,4%	1,2%	69,8%	7,0%	-0,6%	0,1%	0,1%	1,0%	0,0%	-0,3%	0,2%	100,0%
GREEN SENS1_4	21,1%	0,3%	1,2%	66,7%	8,1%	-0,5%	0,0%	2,9%	0,3%	0,0%	-0,2%	0,2%	100,0%
YELLOW	21,5%	0,5%	-2,4%	57,9%	5,6%	-0,7%	0,2%	6,0%	11,2%	0,0%	-0,2%	0,4%	100,0%
BLUE	14,7%	1,4%	1,2%	56,5%	11,6%	1,3%	2,5%	3,6%	2,5%	1,2%	1,4%	2,0%	100,0%
ACER Scen. 4 LCBM August 2020	11,9%	0,3%	17,1%	60,4%	1,8%	0,2%	0,0%	3,5%	4,3%	0,0%	0,0%	0,6%	100,0%
ACER Scen. 4 LCBM March 2021	10,8%	0,1%	14,9%	61,5%	2,0%	0,3%	0,0%	7,2%	3,1%	0,0%	0,0%	0,2%	100,0%

Source: ACER's Defence, paragraph 242.

1243. The Contested Decision does not discriminate against BZs with high levels of renewable energy production.
1244. Appellant III illustrates its claim with the example of Germany. As shown in the table of ACER's Defence above, some BZs have higher shares of RES than Germany whilst their cost contribution is lesser. The DE-LU BZ has a share of RES of 35% to 40%, whereas the Romanian BZ has a share of RES above 40% and the Croatian BZ has a share of RES above 70% according to ENTSO-E, Statistical Factsheet 2018²⁹⁷. However, Germany's cost share (DE) in the various scenarios is of [56.5% to 69.8%], whereas the Romanian cost share (RO) is of [0% to 1.2%] and the Croatian cost share (HR) is of [-0.7% to 1.3%].
1245. As set out in the First Consolidated Plea, Sub-Plea 1.8, climate change measures require investments that can only adequately be carried out in a Core region that is coordinated in terms of RAs. An adequate level of coordination in terms of RDCTs and OS can only be achieved through a corollary cost sharing system, as provided for in the RDCTCS. As set out above, the RDCTCS plays a role in the identification of the most effective CM measures under CACM aims to maximise CZC and ensure OS. In so doing, the Contested Decision's RDCTCS has been designed in way that ensures an adequate level of investments in the long term and provides correct economic signals in accordance with 74 CACM and 16 ER, whilst fostering integration of Core CCR in terms of congestions. This adequate level of investments will foster, in the long term, correct investment initiatives by All Core TSOs and a smooth transition of the entire Core CCR towards decarbonisation.
1246. As more renewable energy is connected, OS challenges will increase across the EU. Given the time lags associated with new transmission investment and BZ reconfiguration, short periods of high RDCT costs are possible. This means that it is particularly important to ensure co-ordination in the execution of RAs in order that overall costs to network users in the EU are minimised.
1247. In this regard, the Board of Appeal refers to Recital 23 ER, which states: *While decarbonisation of the electricity sector, with energy from renewable sources becoming a major part of the market, is one of the goals of the Energy Union, it is crucial that the market removes existing barriers to cross-border trade and encourages investments into supporting infrastructure, for example, more flexible generation, interconnection, demand response and energy storage. To support this shift to variable and distributed generation, and to ensure that energy market principles are the basis for the Union's electricity markets of the future, a renewed focus on short-term markets and scarcity pricing is essential.*
1248. Finally, given that Appellant III highlights the impacts of the Contested Decision's RDCTCS on Germany, the Board of Appeal notes that, as demonstrated in ACER's Defence, reducing the scope of the RDCTCS does not necessarily lead to a reduction of the costs to be borne by DE-LU BZ to ensure security of the network. It will lead to the reduction of the costs to be classified as XNEs which can be shared with Core TSOs. The Board of Appeal refers to ACER's Defence:

Scenario	CATEGORY	DE COSTS (k €)
YELLOW SCENARIO: Only interconnectors constitute XBRNE	NON-CORE	3.5
	NON-XBRNE	1,085.5
	XBRNE	994.9
	TOTAL COSTS	2,083.9
BLUE SCENARIO:	NON-CORE	30.1

²⁹⁷ Annex 39 to the Defence.

XBRNE are, in line with CCM, CNECs: - all CZ NEs - all internal NEs, defined by All Core TSOs, with a BZ-to-BZ PTDF \geq 5%	NON-XBRNE	702.4
	XBRNE	1,302.1
	TOTAL COSTS	2,034.6

Source: ACER's Defence, paragraph 242 and Annexes 24 and 87 to the Defence, with clarifications on the YELLOW and BLUE scenario by the Board of Appeal.

A comparison of the yellow and the blue scenario shows the following:

The blue scenario (CNECs) increases the scope in comparison with the yellow scenario (only interconnectors). However, when the scope of XBRNEs under the RDCTCS is reduced (i.e. a change from blue to yellow), costs for XBRNEs are reduced (from € 1.302,1 k (blue) to € 994.9 k (yellow)) and costs for NON-XBRNEs are increased (from € 702.4 k (blue) to € 1,085.5 € (blue)).

12.2 Priority of loop flows above the threshold.

1249. Appellants III²⁹⁸ and IV²⁹⁹ allege that the prioritisation of LFs above the threshold discriminates against larger BZs because it over-penalises Core TSOs from large BZs. Appellant IV lists the French, German and Luxembourg TSOs as an example. It refers to paragraph 115 of the Contested Decision, where ACER acknowledges that “TSOs from larger zones create larger loop flows”. Appellant IV refers to an analogy with the free movement of workers within the EU but does not develop the analogy.
1250. Appellant III also alleges that the prioritisation of LFs above the threshold discriminates against Member States that foster renewable energy generation. Appellant III argues that the discriminatory dimension of the prioritisation of LFs above the threshold is perpetuated by the alleged excessive scope of the RDCTCS and too low common LF threshold: market barriers are perpetuated where LFs from other BZs – inherent to a zonal model - are penalised whilst not equally penalising IFs.
1251. Appellant IV also alleges that the prioritisation of LFs above the threshold over IFs discriminates against LF polluting TSOs, which have to pay part of the costs of IFs that do not result from LFs but from IFs. It opposes ACER's view in paragraphs 132 and 133 of the Contested Decision that LFs and IFs are different “because the former are caused by the foreign Member State and the latter are caused by the domestic Member State, therefore the users of the foreign Member State should pay first and foremost”.
1252. Appellant IV states, in this respect, that “In essence, ACER argues in paras. 132 and 133 of the Core Cost Sharing Decision that loop flows and internal flows are different because the former are caused by the foreign Member State and the latter are caused by the domestic Member State, therefore the network users of the foreign Member State should pay first and foremost. This would be fair if the consequence was that the network users of the foreign Member State paid only for their contribution to the congestion, namely for their fair share of loop flows. However, the methodology adopted requires that in addition to their contribution, they effectively pay part of the costs that are caused by internal flows stemming from internal transactions. This is particularly evident in situations where under the adopted prioritisation methodology there is no residual congestion at all for which internal flows could be penalised.”
1253. Appellant IV claims that, in a scenario of no-prioritisation of LFs above the threshold, both LFs and IFs would be equally penalised for congestions in proportion to their contribution to congestion. Appellant IV also alleges that the RDCTCS should not differentiate between LFs and IFs because they are equally illegitimate because (i) they have the same physical effect on the NE, in that they cause or intensify the congestion in exactly the same way and (ii) they are caused by the fact that the network infrastructure of a control area of the design of a BZ is not developed in line with the demands for electricity trading.
1254. Appellant VI³⁰⁰ claims that the prioritisation of LFs above the threshold discriminates against TSOs that are managing IFs effectively and efficiently. It furthermore states that Article

²⁹⁸ Appeal III, Plea 3, paras 159-181.

²⁹⁹ Appeal IV, Plea 4, paras 131-186.

³⁰⁰ Appeal VI, Plea 4, paras 177-193.

16(13) ER only applies to XNEs, which justifies in itself their different treatment from other NEs. Appellant VI claims that paragraph 71 of the Contested Decision is erroneous.

1255. Paragraph 71 of the Contested Decision states:“(71) *Excluding some cross-border relevant network elements from cost sharing would also contradict the general principles of congestion management in accordance with Article 16(1) of the Electricity Regulation by which network congestion problems should be addressed with non-discriminatory market-based solutions which give efficient economic signals to the market participants and transmission system operators involved. This general principle was applied in ACER Decision 02/2019 of 21 February 2019 on the Core CCR TSOs’ proposals for the regional design of the day-ahead and PUBLIC Decision No 30/2020 Page 19 of 41 intraday common capacity calculation methodologies. Articles 5 of Annexes I and II of this Decision set out the requirements for Core TSOs to continuously monitor and identify the most efficient congestion management method for congestions on internal network elements, among which are capacity calculation, remedial actions, reconfiguration of bidding zones and network investments. The solution by which congestion problems can be addressed with remedial actions crucially depends on the coordination of remedial actions and related cost-sharing. Thus, in the absence of cost-sharing for specific congested network elements, remedial actions could no longer be considered as an alternative congestion management method for these elements. As a consequence, this would prevent efficient congestion management as required by Article 16(1) of the Electricity Regulation.*”

In Appellant VI’s view, the discrimination alleged by ACER in the above-mentioned paragraph does not hold and ACER should have excluded NEs because the European legislator chose to treat XNEs differently from non-XNEs. It claims that, given that Article 16(13) ER does not contain any provision on non-XNEs, their exclusion from the RDCTCS cannot be discriminatory.

1256. Appellant VI stresses that LFs are caused by (i) the existence of structural congestion within the internal network of a TSO, (ii) the proximity of some generation units at the border of neighbouring TSOs and (iii) the exporting/importing position of a BZ. It highlights that neither Article 16(8) ER nor Article 16(13) ER differentiate between IFs and LFs. It also refers to BNetzA’s position paper³⁰¹: “*If a TSO A has internal network element hosting 30% loop flows and TSO B has a cross-border network element hosting 30% loop flows, applying cost-sharing only for cross-zonal element would lead to discrimination between these two TSOs. Such discrimination cannot be legally justified*”.

1257. Appellant VI also ties its claim to Article 74(6)(a) and (b) CACM. With respect to Article 74(6)(a) CACM, which requires the RDCTCS to “*provide incentives to manage congestion, including remedial actions and incentives to invest effectively*”, Appellant VI alleges that the discrimination between flow components amounts to a *de facto* discrimination between TSOs regarding the incentives to invest effectively.

1258. With respect to Article 74(6)(b) CACM, which requires the RDCTCS to “*be consistent with the responsibilities and liabilities of the TSOs involved (..)*”, Appellant VI alleges that shifting the financial responsibility for eliminating internal bottlenecks or congestion within a TSO’s control area to another would constitute an unjustified differential treatment.

1259. The Board of Appeal refers to the Sixth Consolidated Plea, in particular Sub-Pleas 6.3 and 6.4, which set out the rationale for placing IFs as no.2 of the priority list.

1260. LFs and IFs are different in nature. LFs are unpredictable, caused in another BZ than the BZ of the LF-causing TSO and their unavoidable nature in a zonal market model justifies a threshold for acceptable LFs. IFs are predictable, caused in the BZ of the IF-causing TSO and do not require a threshold because they are not unavoidable in a zonal model and because they are, in any event, subject to the OPP. In addition, IF-causing TSOs are financing the investment and maintenance of internal NEs via network fees or tariffs, whereas LF-causing TSOs are not. Therefore, LFs and IFs are different in nature and should not be penalised equally. Furthermore, LFs stacked as no.1 are LFs that have been differentiated through the filter of a threshold in relation to their contribution to congestion, whereas IFs are unfiltered. This reinforces the fact that LFs above the threshold and IFs should not be penalised equally.

³⁰¹ Annex A.3.8 to Appeal VI, p. 4.

1261. Consequently, given that LFs above the threshold and IFs are different, they should not be treated equally under the principle of non-discrimination. Different flows on similar XNEs should not be treated equally. This would be contrary to the principle of non-discrimination (Articles 20 and 21 Charter, Articles 3(e) and 74(6)(i) CACM, and Article 16(1) ER)). LFs above the threshold are not over-penalised by the prioritisation foreseen by the Contested Decision. Additionally, treating LFs and IFs equal would provide wrong incentives to Core TSOs, as set out above in Sub-Plea 6.6, namely insufficient incentives to LF-causing TSOs to reduce LFs below the threshold and unfair incentives to LF-hosting TSOs to invest, despite the fact that the cause of the congestion lies outside of their responsibility.
1262. Placing IFs as no.2 of the priority list does not discriminate against large BZs. The Contested Decision's RDCTCS applies equally to all BZs of Core CCR. Given that the priority list correctly identifies LFs above the threshold as primary contributors to the congestion, this has as a consequence that the Contested Decision's cost sharing solution will provide TSOs of BZs with a high level of LFs with necessary incentives to reduce LFs below the threshold in order to avoid high costs shares. In this respect, the Board of Appeal refers to ACER's own simulations, which were discussed with Core TSOs and NRAs during the proceedings leading-up to the Contested Decision³⁰².
1263. As set out above in Sub-Plea 6.16, these simulations show that large BZs do not necessarily generate large amounts of LFs above the threshold and do not lead to a larger cost share due to the prioritisation of LFs over IFs. ACER's simulations³⁰³ are as follows:

Scenario (%)	AT	BE	CZ	DE	FR	HR	HU	NL	PL	RO	SI	SK	TOTAL
ACER Scen. 4 LCBM March 2021 ComTh10% IFprior0%*	10,8%	0,1%	14,9%	61,5%	2,0%	0,3%	0,0%	7,2%	3,1%	0,0%	0,0%	0,2%	100,0%
ACER Scen. 5 LCBM March 2021 ComTh10% IFprior100%**	10,4%	0,1%	14,1%	67,0%	1,8%	0,3%	0,0%	3,2%	3,0%	0,0%	0,0%	0,1%	100,0%
ACER Scen. 6 LCBM March 2021 ComTh10% IFprior50%***	10,6%	0,1%	14,4%	65,2%	1,8%	0,3%	0,0%	4,4%	3,1%	0,0%	0,0%	0,2%	100,0%

Source: ACER's Defence and Annex 86 to ACER's Defence.

* ACER Scenario 4 LCBM March 2021 ComTh10% IFprior0% is equivalent to the cost sharing methodology under the Contested Decision with the updated input of March 2021.

** ACER Scenario 5 LCBM March 2021 ComTh10% IFprior100%** provides cost sharing results where LFs and IFs are equally prioritised.

*** ACER Scenario 6 LCBM March 2021 ComTh10% IFprior50%*** provides cost sharing results where 50% of IFs are equally prioritised with LFs.

ACER Scen.4 is the scenario of the Contested Decision.

ACER Scen.5 includes all IFs as no.1 of the priority list alongside LFs above the threshold.

ACER Scen.6 includes 50% IFs as no.1 of the priority list alongside LFs above the threshold.

A comparison of all three scenarios leads to the following conclusions for the German BZ and the French BZ:

-German BZ: cost share increase of respectively 5.5% and 3.8% if IFs are totally or partially prioritised.

-French BZ: cost share decrease of 0.2% if IFs are totally or partially prioritised.

1264. The above simulation evidences that a large BZ such as France has a considerably lower cost share than a large BZ such as Germany. Therefore, LF prioritisation does not discriminate against larger BZs *per se*. It also evidences, secondly, that a change in the priority – e.g. prioritising 50% of IFs or all IFs – does not significantly decrease France's cost share and

³⁰² Annexes 24, 29 to 28 and 86 to the Defence.

³⁰³ Defence, para 602 and Annex 86 to the Defence.

would even increase Germany's cost share.

This leads to the conclusion that the important cost share of Germany is not due to the fact that it is a large BZ and that LF prioritisation discriminates against large BZs. The high cost share of Germany must therefore be related to other causes (these could be, *inter alia*, network deficiencies that generate a high level of LFs). The Board of Appeal refers to the Twelfth Consolidated Plea, where compliance with the principle of non-discrimination is analysed in detail.

1265. Appellant IV's analogy with the free movement of workers within the EU cannot be made because it fails to take due account of zonal market model whereby activities in some zones unpredictably pollute other zones.
1266. Placing IFs as no.2 of the priority list does not discriminate against BZs fostering RES, as set out in Sub-Plea 6.6.
1267. Placing IFs as no.2 of the priority list does not discriminate against LF-causing TSOs, who would have to pay for costs that are provoked by IFs instead of LFs, as set out in Sub-Pleas 6.3 and 6.4.
1268. Placing IFs as no.2 of the priority list does not discriminate against TSOs that are managing IFs effectively and efficiently, as set out in Sub-Pleas 6.6, 6.10 and 6.14. Regarding Appellant VI's claim that Article 16(13) ER only applies to XNEs, which justifies in itself their different treatment from other NEs, the Board of Appeal refers to the First Consolidated Plea regarding the RDCTCS scope and the inclusion of internal XNECs in the RDCTCS scope.
1269. Placing IFs as no.2 of the priority stack does not discriminate in view of alleged requirements of equality between LFs and IFs to be found in Article 16(8) and (13) ER, as set out in Sub-Plea 6.12. Regarding Appellant IV's position paper, Appellant IV's starting-point is erroneous, as set out in Sub-Pleas 6.3 and 6.14.
1270. Placing IFs as no.2 of the priority stack does not discriminate in relation to Article 74(6)(a) and (b) CACM, as set out in Sub-Pleas 6.6, 6.8 and 6.9.

12.3 Threshold for acceptable loop flows.

1271. Appellant II³⁰⁴ alleges that Articles 16(13) ER and 74 CACM require a legitimate LF threshold for each individual BZ and that a common LF threshold infringes the principle of non-discrimination because each BZ generates structurally different LFs depending on their size, location and topological characteristics, e.g. the location of the generation plants and volume of imports/exports.
1272. Appellant III³⁰⁵ claims that larger BZs tend to have more LFs than smaller BZs and that the determination of a low common threshold for acceptable LFs at 10%, without differentiating between specific characteristics of national markets, discriminates against larger BZs. Appellant III illustrates this with the German BZ: because of its large volume of LFs due to its high amount of renewable energy, it will bear an unjustifiable financial burden in case of a common threshold for acceptable LFs of 10%. This, in its view, discriminates against German TSOs and network users and infringes the EU goal of an internal energy market.
1273. Appellant IV³⁰⁶ claims that the LF threshold set by ACER is discriminatory towards larger BZs.
1274. In its Defence³⁰⁷, ACER responds that the Contested Decision's legitimate LF threshold (i) is not discriminatory because of its 2-step approach, (ii) is not discriminatory towards larger BZs with a high share of renewable energy production and (iii) does not perpetuate any discriminatory situation.

³⁰⁴ Appeal II, Plea 5, paras 119-121.

³⁰⁵ Appeal III, Plea 2, paras 150-158.

³⁰⁶ Appeal IV, Plea 3, paras 93-130.

³⁰⁷ Defence, paras 551-557.

1275. Intervener I observes that the common LF threshold is discriminatory because it applies to all BZs together, regardless of their size, shape and geographical location.
1276. The Board of Appeal expresses the preliminary observation that Article 16(13) ER requires a legitimate LF threshold in order to discriminate between LFs below the threshold and LFs above the threshold, and penalise the latter. Hence, Appellants' claim of an infringement of the principle of non-discrimination applies to the setting of the value of a threshold, the aim of which is to discriminate, in order to accept some LFs and penalise others on the basis of the PPP.
1277. As set out above in the Seventh Consolidated Plea, Sub-Plea 7.5, the appropriate value for the legitimate LF threshold is conditioned by the legal requirement of Article 16(13) ER that it be determined in the absence of structural congestion. When determining the value of the legitimate LF threshold in the first step, the starting point is a situation whereby Core BZs do not experience structural congestion. The rationale of the test is that BZs without structural congestion do not bear the costs caused by BZs with structural congestion. This first step of the determination of the LF threshold is not discriminatory: it applies equally to all BZs of the Core CCR.
1278. As set out above in Sub-Pleas 7.4 and 7.9, the common LF threshold set in the first step is subsequently split between individual Core BZs and the splitting method has precisely been chosen to duly take account of structural congestion and avoid discrimination between BZs (proportionate splitting would be discriminatory). This is set out in more detail in Sub-Plea 12.4 below.
1279. Consequently, the setting of the value of the threshold in each of the steps of the two-step approach is not discriminatory.
1280. The fact that, as a result of the legitimate LF threshold, BZs with a high level of LFs (above the threshold) will bear a high part of the costs and BZs with a low level of LFs (below the threshold) will not bear any costs, complies with the requirement of Article 16(13) ER. That is precisely what threshold has been set for.
1281. Large BZs are not discriminated against by the value of the LF threshold. Appellant III's claim that a higher LF threshold value than 10% should be set for larger BZ would infringe the requirement of Article 16(13) ER. The law requires that the threshold is determined in a situation of BZs without structural congestion, i.e. a situation whereby LFs and internal congestions are taken out of the equation. Any claim of the infringement of the principle of non-discrimination must be assessed in a structural congestion free situation.
1282. Proof that large BZs are not discriminated against by the value of the LF threshold is that, as set out in Table 9 of Sub-Plea 7.5, the cost share of France for coordinated RAs taken during 10 timestamps of All Core TSOs' RDCTCS Experimentation Report under ACER scenario 4 amounts to 2%. The French BZ constitutes a large BZ.
1283. The fact that Germany (DE-LU) will likely bear a high cost share, as shown in Sub-Plea 7.5, is not due to the fact that it is a large BZ but due to the fact Article 16(13) ER requires the LF threshold to be determined in the absence of structural congestion. If Germany is characterised by a situation of structural congestion with a high level of LFs, i.e. a level that is above the situation in which a BZ is considered as without structural congestion, it is likely to bear a high cost share. The LF threshold aims precisely at penalising LFs above the threshold in a situation without structural congestion and, consequently, at incentivising appropriate measures to reduce LFs to a level below the threshold, e.g. by means of network investments or BZ reconfigurations.
1284. Furthermore, the splitting method of the common LF threshold between BZs, foreseen in the Contested Decision's RDCTCS, softens any disproportionate impact that BZs with structural congestion and a high level of LFs may experience, whilst correctly relieving BZs without structural congestion and a low level of LFs: BZs with structural congestion and a high level

of LFs may benefit from the fact that BZs without structural congestion and a low level of LFs are not utilising their individual LF threshold to the full extent.

1285. Also, the legitimate LF threshold of the Contested Decision does not discriminate against BZs with high RES levels.
1286. First, All Core TSOs are subject to identical environmental targets.
1287. Second, as set out above in the First Consolidated Plea, Sub-Plea 1.8, climate change measures require investments that can only adequately be carried out in a Core region that is coordinated in terms of RAs. An adequate level of coordination in terms of RDCTs and OS can only be achieved through a corollary cost sharing system, as provided for in the RDCTCS and, as set out in the Fourteenth Consolidated Plea, Sub-Plea 14.2, a LF threshold is indispensable for the RDCTCS.
1288. As set out above, the RDCTCS plays a role in the identification of the most effective CM measures under CACM. It aims to maximise CZC and ensure OS. The Contested Decision's RDCTCS has been designed in way that ensures an adequate level of investments in the long term and provides correct economic signals in accordance with 74 CACM and 16 ER, whilst fostering integration of Core CCR in terms of congestions. This adequate level of investments will foster, in the long term, correct investment initiatives by All Core TSOs and a smooth transition of the entire Core CCR towards decarbonisation.

12.4 Equal splitting of the common LF threshold.

1289. Appellant IV³⁰⁸ claims that the splitting method of the Contested Decision's RDCTCS is discriminatory because it over-penalises Core TSOs operating highly meshed control areas, like the French, German and Luxembourg TSOs, to the benefit of Core TSOs from less meshed control areas.
1290. Intervener I observes that the splitting method of the Contested Decision's RDCTCS is discriminatory because it disregards the size, shape and geographical location and variability of the generation and load patterns of each individual BZ.
1291. As set out in the Seventh Consolidated Plea, Sub-Plea 7.9, and in Sub-Plea 12.3, the determination of the legitimate LF threshold, including its splitting per BZ, is based on Article 16(13) ER and its requirement to take account of structural congestion.
1292. Splitting in accordance with the Contested Decision's RDCTCS duly takes account of structural congestion and avoids discriminating against BZs without structural congestion and a low level of LFs. Indeed, it splits the common LF threshold equally between BZs and provides that, if Core BZs have a level of LFs below the equally divided individual BZ LF threshold (negative value), this negative leftover value of usable but unused LFs can be redistributed to relieve Core BZs having a level of LFs above the threshold. Consequently, it sets the LF threshold level in accordance with a situation with no structural congestion because BZs with no structural congestion do not contribute to XRA costs.
1293. Conversely, proportional splitting of the common LF threshold does not set the LF threshold level in accordance with a situation with no structural congestion. Proportional splitting would discriminate against BZs with no structural congestion and a low level of LFs and would require them to contribute to XRA costs.

12.5 Netting of flow components.

1294. Appellant V³⁰⁹ claims that the Contested Decision's netting approach is discriminatory.
1295. As has been set out in detail in the Fifth Consolidated Plea, Article 7(6) of the Contested Decision's RDCTCS contains a netting process with respect to the calculation of the overload but does not contain an additional netting process for cost distribution.

³⁰⁸ Appeal IV, Plea 3, paras 93-130.

³⁰⁹ Appeal V, Plea 2, Sub-Plea 5, paras 173-178.

1296. The Contested Decision could not have ensured compliance with the Article 74 CACM if an additional netting process would have been introduced when allocating flow types to the overload. An additional netting process when allocating flow types to the overload would have infringed Article 16(13) ER and the PPP, as has been explained in detail in the Fifth Consolidated Plea. It would have allowed some burdening LFs to escape the PPP even though they exceeded the legitimate LF threshold. This would have given wrong incentives to Core TSOs causing LFs not to take the necessary measures to reduce LFs in general (be they burdening or relieving). This would, in turn, have discriminated between TSOs.
1297. The Contested Decision's approach, which does not contain an additional netting process regarding the allocation of flow types to the overload, ensures that no discrimination arises between Core TSOs.

12.6 Restrictions on HVDC elements in flow decomposition.

1298. Appellant V³¹⁰ claims that the Contested Decision's RDCTCS discriminates between CZ HVDC and internal HVDC lines. It alleges that CZ HVDC lines, e.g. the "Aachen Liège Electricity Grid Overlay" or ALEGrO over Germany and Belgium, are not subject to the same restrictions as internal HVDC NEs.
1299. Appellant V also claims that the Contested Decision's RDCTCS discriminates between HVDC and AC lines. This is because, in its view, the inclusion of internal HVDC NEs in the RDCTCS is facing restrictions which lead to an additional cost exposure for the owners of these lines, which amounts to a disadvantageous, discriminatory treatment of internal HVDC NEs as compared to other lines such as AC lines. HVDC lines should, in its view, not be treated differently than AC lines because they are comparable, the only difference being that both their direction and magnitude are controllable.
1300. As set out in the Third Consolidated Plea, Sub-pleas 3-18 to 3.20, the treatment of HVDC NEs in the PFC method correctly identifies IFs and LFs, which enables a correct application of the PPP in the attribution of costs to TSOs. It allows for a correct identification of the polluting flows, namely IFs and LFs. It also allows for a correct decomposition of IFs and LFs, which is a preliminary step to allow for a determination of a *de minimis* LF threshold.
1301. Regarding the difference between internal and CZ HVDC NEs, Sub-plea 3.17 of the Third Consolidated Plea sets out the technical difference between internal HVDC NEs and CZ HVDC NEs.
1302. Given that there is no allocation (CA) within a BZ, internal HVDC NEs do not operate on the basis of CA and their use is *per se* restricted to minimising internal congestions. Consequently, flows on internal HVDC NEs are unrelated to CA. In other terms, flows on internal HVDC NEs are not allocated by CA, i.e. they are not AFs. The Contested Decision's RDCTCS does not introduce a restriction on the flow decomposition of internal HVDC NEs. Flow decomposition in relation to internal HVDC NEs is *per se* conditioned by their nature. The Contested Decision's RDCTCS correctly states that exchanges over internal HVDC NEs may be decomposed only into IFs on such NE as well as IFs and LFs on NEs impacted by them.
1303. This also explains why the Contested Decision's RDCTCS decomposes the flows of CZ HVDC NEs only in AFs on such NE and on NEs impacted by them. CZ HVDC NEs operate on the basis capacity allocation. CZ HVDC NEs can only carry exchanges between 2 BZs. Their use is *per se* restricted to AFs. CZ HVDC NEs do not carry IFs because IFs are per definition flows within a BZ, where no allocation takes place. CZ HVDC NEs do not carry LFs because LFs are caused by internal transactions, i.e. exchanges within a BZ, where no allocation takes place. The flow transmitted by CZ HVDC lines on a NE correspond with the volume of allocated CZC on such lines.

³¹⁰ Appeal V, Plea 2, paras 46-178.

1304. This is correctly reflected in paragraph 99 of the Contested Decision: *“In power flow colouring method the cross-zonal HVDC network element is assumed to transport only cross-zonal exchanges and thereby change allocated flows in surrounding alternating current (‘AC’) networks. On the other hand, the internal HVDC network element is assumed to transport.”*
1305. Consequently, the different treatment of internal HVDC NEs and CZ HVDC NEs as regards flow decomposition stems from the intrinsic, objective differences between both types of NEs. Appellant V’s appeal erroneously claims that the flow decomposition method of the Contested Decision imposes restrictions on HVDC NEs. Any restriction relating to the decomposition of flows on HVDC NEs stems from their intrinsic nature. Moreover, any flow decomposition method that does not respect the intrinsic different nature of CZ HVDC NEs and internal HVDC NEs cannot be in compliance with Article 74 CACM as upfront flaws would be created in flow decomposition, which would distort the ensuing cost distribution.
1306. Regarding the difference between AC technology and HVDC technology, the Contested Decision’s RDCTCS contains specific provisions for HVDC technology in its Article 6(8) precisely because of its technical differences, which Appellant V recognises in paragraphs 160 and 168 of its appeal (recognising that *“the only difference”* between HVDC lines and AC lines is *“that both their direction and magnitude are controllable”*, and calling AC technology *“less efficient technology”*). The technical differences between AC technology and HVDC technology justify a different treatment without infringing the principle of non-discrimination.
1307. Also, with respect to the *“additional cost exposure”* of internal HVDC lines (the alleged *“disadvantageous, discriminatory treatment of internal HVDC NEs as compared to other lines such as AC lines”*), it has to be noted that, according to the illustrations provided by both Appellant V and the Defendant, the FLD method - which Appellant V puts forward as being the correct flow decomposition method for RDCTCS – generates a higher level of LFs than the PFC method on internal HVDC NEs.
1308. Finally, as set out in Sub-Plea 3.6 of the Third Consolidated Plea, by contrast, the distortions created by the FLD method as regards cost distribution would infringe the principle of non-discrimination as it would introduce an unjustified element of discrimination between Core TSOs, due to its incompatibility with the zonal market model.

12.7 Cumulative effect of various infringements.

1309. Appellant III³¹¹ argues that the discriminatory dimension of the too low common LF threshold of the Contested Decision’s RDCTCS is perpetuated by the alleged excessive scope of the RDCTCS (see, First Consolidated Plea): the more internal NEs are included into the RDCTCS, the more LFs above threshold will be taken into account in the RDCTCS.
1310. Appellant III also argues that the discriminatory dimension of the prioritisation of LFs above the threshold is perpetuated by the alleged excessive scope of the RDCTCS and too low common LF threshold: market barriers are perpetuated where LFs from other BZs – inherent to a zonal model - are penalised whilst not equally penalising IFs.
1311. In its Reply³¹², Appellant III reiterates that the combination of the 3 errors in law lead to a perpetuation of discrimination of Appellant III.
1312. Having found no infringement in the First Consolidated Plea and having found no infringement of the principle of non-discrimination in Sub-Pleas 12.2 and 12.3, the Board of Appeal does not identify a cumulative effect of infringements.
1313. **It follows that the Twelfth Consolidated Plea must be dismissed as unfounded.**

³¹¹ Appeal III, Plea 2, paras 155-156.

³¹² Reply of Appellant III, paras 62-64.

Thirteenth Consolidated Plea – Lack of Impact Study.

1122. Appellant II³¹³ alleges that by failing to impose an impact study to evaluate the financial consequences for each TSO of the design options for key cost sharing parameters, ACER has breached Articles 74(6)(c) CACM and 16(13) ER. In Appellant II's view, such impact study should have considered future network conditions at the time when the RDCTCS would be implemented, i.e. at the earliest in 2024, and would have analysed the consequences of the modifications that the Contested Decision's RDCTCS brought to the cost sharing parameters used in All Core TSOs' Experimentation Report. Appellant II tabled its request for an impact study as a comment during ACER's BoR approval process in November 2020³¹⁴.
1123. Appellant II claims that the RDCTCS is only able to meet the standard of a fair distribution of costs and revenues between All Core TSOs according to Articles 74(6)(c) CACM and 16(13) ER if a prior impact study has been carried out. A cost sharing methodology not being preceded by such impact study would not be able to comply with said legal standard.
1124. In its Defence³¹⁵, ACER responds that (i) the requirement of a fair distribution of costs and benefits set out by Articles 74(6)(c) CACM and 16(13) ER aims at achieving the goal pursued by the relevant EU legal framework i.e., ensuring and maintaining the security of energy supply, reflected in Article 16(1) ER; (ii) ACER was under no legal obligation to conduct an impact study; (iii) ACER had a limited time of 6 months to adopt the Contested Decision in accordance with Articles 6(10) ACER Regulation and 9(11) CACM; (iv) ACER made a careful analysis in light of the discussions held with Core TSOs and NRAs and information provided from them during this consultation, including Core NRAs' Non-Paper, All Core TSOs' RDCTCS Explanatory Document to the Proposal, All Core TSOs' RDCTCS Non-Paper and All Core TSOs' Experimentation Report and (v) the Contested Decision's RDCTCS ensures a fair distribution of costs and benefits between Core TSOs.
1125. Article 74(6)(c) of the CACM Regulation requires the RDCTCS to *"ensure a fair distribution of costs and benefits between the TSOs involved"*. Article 16(13) ER requires that, when allocating costs of RAs between TSOs, regulatory authorities *"analyse to what extent flows resulting from transactions internal to bidding zones contribute to the congestion between two bidding zones observed, and allocate the costs based on the contribution to the congestion to the transmission system operators of the bidding zones creating such flows except for costs induced by flows resulting from transactions internal to bidding zones that are below the level that could be expected without structural congestion in a bidding zone. That level shall be jointly analysed and defined by all transmission system operators in a capacity calculation region for each individual bidding zone border, and shall be subject to the approval of all regulatory authorities in the capacity calculation region."*
1126. The applicable regulatory framework does not require an impact study prior to the adoption of the Contested Decision on the RDCTCS. Neither the ER, nor the CACM, nor the ACER Regulation imposes the performance of an impact study. Article 16(13) ER requires All Core TSOs to submit for approval to regulatory authorities a joint flow level analysis on each BZB (on the flow level expected without structural congestion in a BZ to be used as threshold). Article 16(13) ER requires regulatory authorities to analyse the contribution of internal BZ transactions flows to the congestion between 2 BZs and allocate costs according to that contribution, with due exception for costs from flows below the threshold. Similarly, Article 74(6)(c) CACM requires the RDCTCS to ensure a fair distribution of costs and benefits between All Core TSOs, without imposing the performance of an impact study.
1127. Neither All Core NRAs, nor ACER – following All Core NRAs' referral – were under any obligation to conduct an impact study. ACER's regulatory obligation was to analyse the contribution of flows from internal BZ transactions to the congestion between 2 BZs and allocate costs according to that contribution, with due exception for costs from flows below

³¹³ Appeal II, Plea 2, paras 74-79.

³¹⁴ Annex 3 to Appeal II.

³¹⁵ Defence, paras 648-656.

the threshold (on which All Core TSOs would have made an analysis) and ensuring a fair distribution of costs and benefits between All Core TSOs.

1128. The Contested Decision's RDCTCS complies with Article 74(6)(c) CACM. The removal of any sub-set of XNEs from the scope of the RDCTCS would be contrary to Article 74(6)(c) CACM, which requires the RDCTCS to "*(c) ensure a fair distribution of costs and benefits between the TSOs involved*". It suffices to indicate that, due to the discriminatory treatment between TSOs that own internal XNEs and TSOs that own CB XNEs or interconnectors (assuming that this is the distinction meant by "*congestions between two bidding zones observed*"), the cost sharing solution provided by the RDCTCS would not be fair if not applied to its full scope of XNEs
1129. The Contested Decision's RDCTCS complies with Article 16(13) ER.
1130. Article 16(13) ER orders regulatory authorities to analyse to what extent flows resulting from transactions internal to BZs contribute to the congestion between 2 BZs observed and requires. It also requires All Core TSOs to jointly analyse a level of "*flows resulting from transactions internal to bidding zones that are below the level that could be expected without structural congestion in a bidding zone*", adding that "*that level shall be jointly analysed and defined by all transmission system operators in a capacity calculation region for each individual bidding zone border, and shall be subject to the approval of all regulatory authorities in the capacity calculation region.*"
1131. ACER asked All Core TSOs to set the legitimate LF threshold required by Article 16(13) ER in a 4 month deadline (by 20 August 2020). In the absence of compliance by All Core TSOs, ACER was under a duty to ensure compliance with Article 16(13) ER. ACER was not in a position to conduct the in-depth LF analysis required by Article 16(13) ER in a month time (from 20 August 2020, when TSOs did not provide requested analysis at the end of the hearing, until the 6-month deadline for ACER to take the RDCTCS decision, which ended on 27 September 2020). Such in-depth LF threshold study per BZ would have required ACER to first determine a situation with no structural congestion in any BZ. This would have required a protracted analysis of, *inter alia*, network investments and alternative BZ configurations which would address and remove all structural congestions in all Core BZs).
1132. ACER therefore determined a temporary common threshold for legitimate LFs, following a rigorous analysis of the results from All Core TSOs' Experimentation Report, All Core TSOs' Non-Paper, All Core NRAs' Non-Paper and the results from ACER's own simulations using a variety of parameters.
1133. The Contested Decision's RDCTCS correctly decomposes the different types of flows on each XNEC in order to identify IFs and LFs (Article 6 of the Contested Decision's RDCTCS) and sets a *de minimis* threshold for LFs and not for IFs (Article 7(3) and (4) of the Contested Decision's RDCTCS). The OPP applies to IFs and LFs below the threshold, whereas the PPP applies to LFs above the threshold. The legitimate LF threshold is a temporary legitimate LF threshold which will automatically be replaced by a definitive legitimate LF threshold as soon as All Core TSOs agree upon such threshold and upon approval of All Core NRAs (see, Seventh Consolidated Plea). Furthermore, LFs above the threshold are prioritised in the prioritisation of flows when distributing costs. Article 7(6) of the Contested Decision's RDCTCS states that costs of LFs above the threshold come first in the prioritisation and will be attributed to the TSO causing the LF (Article 7(6)(a) of the Contested Decision's RDCTCS). Costs of IFs come second in the prioritisation and will be attributed to the TSOs XNE connecting TSO (Article 7(6)(b) of the Contested Decision's RDCTCS). The rest of the flows will come third and also be attributed to the XNE connecting TSO (Article 7(c) of the Contested Decision's RDCTCS).
1123. ACER duly carried out the analysis that it was required to conduct in accordance with the applicable regulatory framework's bottom-up decision-making process. The proceedings leading-up to the Contested Decision evidence an in-depth analysis of All Core TSOs'

RDCTCS Proposal, RDCTCS Explanatory Document³¹⁶ and Experimentation Report³¹⁷, as well as All Core NRAs' Non-Paper; close cooperation and extensive consultation between ACER and All Core NRAs and TSOs through teleconferences, meetings and exchange of amendments, including discussions in ACER's Electricity Working Group; an in-depth analysis of All Core TSOs' Non-Paper; and a hearing phase with All Core NRAs and TSOs from 31 July 2020 until 20 August 2020.

1124. **It follows that the Thirteenth Consolidated Plea must be dismissed as unfounded.**
1125. Appellants' claims on an infringement of the principle of proportionality are dealt with in the Eleventh Consolidated Plea.

Fourteenth Consolidated Plea – ACER exceeded its competence and infringed the principle of conferral.

14.1 RDCTCS scope.

1126. Appellant IV³¹⁸ claims that, by amplifying the RDCTCS scope, ACER infringes the principle of conferral under Articles 5(1) and (2) TEU because ACER lacks a legal basis and the competence to determine that internal NEs, especially NEs that are not significantly impacted by electricity trades between 2 BZs, shall be subject to cost sharing under Article 74 CACM.
1127. Appellant IV also alleges that the RDCTCS scope leads to interpreting Article 74 CACM in such a way that the provision goes beyond its legal basis, i.e. Article 18(3)(b) and (5) Old ER, which has been replaced by Article 61(4)(a), (5) and (6) ER. Appellant IV invokes Article 1(c) and (d) ER to underline that the European Commission was only empowered to adopt a CACM that addresses issues of CB relevance. It further cites Article 74(4)(b) CACM requiring the RDCTCS to “define which costs incurred from using redispatching or countertrading to guarantee the firmness of cross-zonal capacity are eligible for sharing between all the TSOs of a capacity calculation region in accordance with the capacity calculation methodology set out in Articles 20 and 21”. In its view, costs incurred from using such RDCT actions to guarantee the firmness of IFs fall outside the scope of Article 74 CACM.
1128. Appellant V³¹⁹ alleges that the CACM is an implementing act of the ER and may, therefore, not amend or supplement the ER, as this would violate Article 291 TFEU. This, in its view, limits the RDCTCS scope to electricity trading, which depends on the existence of sufficient CZC and the lack of congestion. It refers to Recital (3) CACM
1129. Appellant VI³²⁰ claims that, by adopting the Contested Decision's RDCTCS, especially its Articles 3 and 7, ACER expanded the scope of the NEs subject to the RDCTCS and acted *ultra vires*, namely beyond the limits of the competences set out in the ACER Regulation. It alleges that the Contested Decision's RDCTCS erroneously allocates costs that are not of (direct) CB relevance.
1130. At the Oral Hearing, Appellant VI held that ACER relies upon the principle of non-discrimination to broaden the RDCTCS scope.
1131. The Defence³²¹ responds that ACER was competent to adopt the Contested Decision under Articles 5(3) and 6(10) ACER Regulation. It also replies that (i) the costs to be covered by the Contested Decision's RDCTCS comply with the ER, (ii) ACER did not amend the provisions of the ER, and (iii) ACER did not breach Article 291(2) TFEU.
1132. Article 5(1) TEU states that “The limits of Union competences are governed by the principle of conferral. The use of Union competences is governed by the principles of subsidiarity and proportionality.”

³¹⁶ Annex 13 to the Defence.

³¹⁷ Annex 23 to the Defence.

³¹⁸ Appeal IV, Plea 1, paras 29-65.

³¹⁹ Appeal V, Plea 1, paras 22-45.

³²⁰ Appeal VI, Plea 1, paras 93-124.

³²¹ Defence, paras 188-202, 238, 312-331.

1133. Article 5(2) TEU states that “Under the principle of conferral, the Union shall act only within the limits of the competences conferred upon it by the Member States in the Treaties to attain the objectives set out therein. Competences not conferred upon the Union in the Treaties remain with the Member States.
1134. The principle of conferral set out in Article 5(1) and (2) TEU is a fundamental principle of EU law, according to which the EU acts only within the limits of the competences that EU Member States have conferred upon it in the Treaties. These competences are defined in Articles 2 to 6 TFEU. There are 4 types of competences: (i) exclusive competences (Article 3 TFEU): only the EU can act in these areas e.g. customs union & trade policy; (ii) shared competences between the EU and EU countries (Article 4 TFEU): EU countries can act only if the EU has chosen not to act, e.g. cohesion policy, energy & environment; EU countries may ask the Commission to repeal an adopted legislative act in one of the shared areas so as to better ensure compliance with the principles of subsidiarity and proportionality (Declaration No 18 annexed to the Treaty of Lisbon); (iii) special competences (Article 5 TFEU): the EU can take measures to ensure that EU countries coordinate their economic, social and employment policies at EU level, e.g. economic policy; and (iv) supporting competences (Article 6 TFEU): the EU can only intervene to support, coordinate or complement the action of EU countries, e.g. culture & tourism. Competences not conferred on the EU by the Treaties thus remain with EU countries. The principle of conferral implies that every secondary legal act must have a legal basis in specific Treaty articles or primary EU law, subject to control by the European Courts. While the principle of conferral governs the limits to EU competences, the use of those competences is governed by the principles of subsidiarity and proportionality.
1135. Under the principle of conferral, energy is a shared competence (Article 4 TFEU): the EU and EU countries are able to legislate and adopt legally binding acts. EU countries exercise their own competence where the EU does not exercise, or has decided not to exercise, its own competence.
1136. ACER’s competences are shared competences within the meaning of Article 4 TFEU. When exercising these EU competences, it is subject to two fundamental principles laid down in Article 5 TEU, namely the principle of proportionality (the content and scope of EU action may not go beyond what is necessary to achieve the objectives of the Treaties) and the principle of subsidiarity (in the area of its non-exclusive competences, the EU may act only if — and in so far as — the objective of a proposed action cannot be sufficiently achieved by the EU countries, but could be better achieved at EU level).
1137. ACER took the Contested Decision on the basis of Article 6(10) of the ACER Regulation: “ACER shall be competent to adopt individual decisions on **regulatory issues having effects on cross-border trade or cross-border system security** which require a joint decision by at least two regulatory authorities, (...)”. (emphasis added). That is the legal basis of the Contested Decision, including the RDCTCS in its Annex 1. That is, therefore, the legal basis of Articles 1 (Subject matter and Scope), 2 (Definitions), 3 (XRAs and XNECs eligible for cost sharing) and 7 (Distribution of costs on XNECs to TSOs) of the RDCTCS.
1138. When adopting the Contested Decision, ACER was therefore competent to decide on the regulatory issues of the RDCTCS in order to avoid a deadlock situation deriving from a disagreement between All Core NRAs within the set deadline. As set out in Recital (10) ACER Regulation, “ACER was established to fill the regulatory gap at Union level and to contribute towards the effective functioning of the internal markets for electricity and natural gas,”
1139. ACER exercised its shared competences regarding energy on the basis of Article 6(10) of the ACER Regulation. ACER did not exceed its competence. ACER’s competence on the basis of Article 6(10) of the ACER Regulation has to be situated in a bottom-up decision-making process foreseen by EU energy regulation, as expressly acknowledged by Appellant VI³²². In this bottom-up decision-making process, the role of the regulators – either the NRAs or

³²² Appeal VI, Plea 1, para 102.

ACER – is to assess whether TSO proposals comply with the applicable regulatory framework in order to subsequently grant regulatory approval. This is in accordance with the Board of Appeal’s earlier case-law³²³.

1140. Indeed, the bottom-up decision-making process provides that the initiative comes from the market (TSOs) but is supervised by regulatory authorities (NRAs or ACER) to ensure adequate regulatory compliance by private companies having private interests, in particular on CB issues. In the present case, All Core NRAs referred decision-making on All Core TSOs’ RDCTCS Proposal to ACER on the basis of Article 9(11) CACM: *“Where the regulatory authorities have not been able to reach agreement within the period referred to in paragraph 10, or upon their joint request, the Agency shall adopt a decision concerning the submitted proposals for terms and conditions or methodologies within six months, in accordance with Article 8(1) of Regulation (EC) No 713/2009.”*
1141. ACER carried out the regulatory supervision of All Core TSOs’ RDCTCS Proposal under the CACM which had been referred to it by All NRAs in accordance with the CACM’s referral procedure. In so doing, ACER found that, given that a scope covering XBRNEs and non-XBRNEs was not in accordance with Article 74(2) CACM, which requires the RDCTCS to *“include cost-sharing solutions for actions of cross-border relevance”*. ACER did not bestow additional powers on itself beyond the powers conferred by the ACER Regulation. It exercised the powers that it was under an obligation to exercise in Article 6(10) of the ACER Regulation, following a referral by All Core NRAs under Article 9(11) CACM and Article 5(3) ACER Regulation.
1142. Article 6(10)(a) ACER Regulation states that the Agency shall be competent to adopt individual decisions as specified in the first subparagraph - which stipulates that ACER shall be competent to adopt individual decisions on regulatory issues effects on CB trade or CB system security which require a joint decision by at least two regulatory authorities, where such competences have been conferred on the regulatory authorities under certain legal acts - *“(a) where the competent regulatory authorities have not been able to reach an agreement within six months of referral of the case to the last of those regulatory authorities”*. Article 6(12)(a) ACER Regulation binds ACER to a six-month deadline to take a decision: *“Where a case has been referred to ACER under paragraph 10, ACER: (a) shall issue a decision within six months of the date of referral (...)”*.
1143. Recital (19) ACER Regulation states that *“(...) ACER’s role with regards to monitoring and contributing to the implementation of the network codes and guidelines has increased”*. Recital (19) ACER Regulation adds that *“the effective monitoring of network codes and guidelines is a key function of ACER and is crucial to the implementation of internal market rules.”* In so doing, ACER has the competence to *“fill the regulatory gap at Union level and to contribute towards the effective functioning of the internal markets for electricity and natural gas”* (Recital (10) ACER Regulation) and, what is more, to coordinate and, where necessary, complete the NRAs’ regulatory functions (Recital (11) ACER Regulation). Recital (11) ACER Regulation stipulates that *“ACER should ensure that regulatory functions performed by the regulatory authorities in accordance with Directive (EU) 2019/944 of the European Parliament and of the Council (10) and Directive 2009/73/EC of the European Parliament and of the Council (11) are properly coordinated and, where necessary, completed at Union level.”*
1144. In exercising its competence, ACER was, according to Article 5(1), (3) and (4) TEU, bound by the principles of subsidiarity and proportionality. As has been set out in the First Consolidated Plea, ACER carried out its competences within the boundaries of the principle of subsidiarity. As has been set out in the Eleventh Consolidated Plea, ACER carried out its competences within the boundaries of the principle of proportionality.
1145. Appellant VI claims that ACER’s interpretation of Article 16(13) ER with respect to the scope of the RDCTCS amounts to an amendment of the contents of the ER and that ACER had no competence to amend the contents of Old ER or New ER. It refers to Recital (73) ER: *“In order to ensure uniform conditions for the implementation of this Regulation, implementing powers in*

³²³ Board of Appeal Decisions A-004-2019, para 233; A-001-2020, paras 14, 102, 106, 138, 139, 160, 161, 184, 188, 234 and 258; A-002-2020, paras 14, 102, 106, 139, 140, 161, 162, 185, 189, 235 and 259; A-003-2020, para 14; A-007-2020, paras 5, 14, 68, 103 and 104; and A-008-2020, paras 19, 113-115, 138, 150, 153, 165, 167, 175, 188, 218, 239, 250, 290, 297 and 326.

accordance with Article 291 of TFEU should be conferred on the Commission. Those powers should be exercised in accordance with Regulation (EU) No 182/2011 of the European Parliament and of the Council (15). The examination procedure should be used for the adoption of those implementing acts.”

1146. As set out in the First Consolidated Plea, the scope of the Contested Decision’s RDCTCS does not infringe Article 16(13) ER. As to Recital (73) ER, this Recital confirms the European Commission’s powers to implement the ER in accordance with Article 291 TFEU. The European Commission implemented the ER, *inter alia*, by adopting the CACM.
1147. Appellant VI refers, in this regard, to paragraph 68 of the Contested Decision, which reads as follows: “*Article 16(13) of the Electricity Regulation specifies a clear cost sharing solution (i.e. based on contributions from flows resulting from internal transactions) for congestion between two bidding zones observed. However, Article 16(13) of the Electricity Regulation does not specify that cost sharing should be applied only for congestion between two bidding zones observed (regardless of the exact interpretation of what the congestion between two bidding zones observed means). Therefore, Article 16(13) of the Electricity Regulation does not prevent, per se, that for network elements which would not be covered by the interpretation of the ‘congestion between two bidding zones observed’, the same cost sharing solution as for congestion between two bidding zones observed (or another cost sharing solution) can be applied.*”
1148. Paragraph 68 of the Contested Decision has to be read in the context of ACER’s full analysis of the RDCTCS scope in Section 6.2.2.1 “*Determination of cross-border relevant network elements eligible for cost sharing*” of the Contested Decision, paragraphs 64 to 81. It has to be read in the context of the referral by Articles 1 and 3 of the Contested Decision’s RDCTCS to the scope of the RDCT (ACER Decision 35/2020) and the scope of the ROSC (ACER Decision 33/2020). As set out in the First Consolidated Plea and the Eleventh Consolidated Plea, all three methodologies are inevitably linked *per se*. All Core TSOs’ RDCTCS Proposal correctly linked the RDCTCS to CROSA. ACER carried out its competences within the boundaries of the principle of subsidiarity and proportionality.
1149. Appellant VI correctly sets out that the European Commission adopted the CACM as an implementing act on the basis of the Old ER (part of the EU’s Third Energy Package³²⁴). Applicant VI claims that the CACM does not confer autonomous powers to ACER, an administrative agency, that go beyond the powers of the applicable regulatory framework. In so doing, it refers to Recital 16 of the ACER Regulation, narrowly defining ACER’s powers, and to CJEU cases C-270/2 *ESMA*³²⁵ and C-9/56 *Meroni*³²⁶.
1150. Recital (16) ACER Regulation states “*ACER provides an integrated framework which enables the regulatory authorities to participate and cooperate. That framework facilitates the uniform application of the legislation on the internal markets for electricity and natural gas throughout the Union. As regards situations concerning more than one Member State, ACER has been granted the power to adopt individual decisions. That power should, under clearly specified conditions, cover technical and regulatory issues which require regional coordination, in particular those concerning the implementation of network codes and guidelines, cooperation within regional coordination centres, the regulatory decisions necessary to effectively monitor wholesale energy market integrity and transparency, decisions concerning electricity and natural gas infrastructure that connects or that might connect at least two Member States and, as a last resort, exemptions from the internal market rules for new electricity interconnectors and new gas infrastructure located in more than one Member State.*”
1151. Recital (16) ACER Regulation confirms ACER’s powers to adopt individual decisions, such as the Contested Decision, and confirms that ACER’s powers cover, under clearly specified

³²⁴ EU regulatory package aimed at improving the functioning of the internal energy market and resolving certain structural problems, covering the areas of unbundling, independent regulators, ACER, cross-border cooperation and open and fair retail markets. Composed of: (i) Directive 2009/72/EC of the European Parliament and of the Council of 13 July 2009 concerning common rules for the internal market in electricity and repealing Directive 2003/54/EC; (ii) Regulation (EC) No. 714/2009 of the European Parliament and of the Council of 13 July 2009 on conditions for access to the network for cross-border exchanges in electricity; (iii) Directive 2009/73/EC of the European Parliament and of the Council of 13 July 2009 concerning common rules for the internal market in natural gas and repealing Directive 2003/55/EC; (iv) Regulation (EC) No 715/2009 of the European Parliament and of the Council of 13 July 2009 on conditions for access to the natural gas transmission networks and repealing Regulation (EC) No 1775/2005; (v) Regulation (EC) No 713/2009 of the European Parliament and of the Council of 13 July 2009 establishing an Agency for the Cooperation of Energy Regulators.

³²⁵ Case C-270/12 *United Kingdom v European Parliament and Council*, EU:C:2014:18.

³²⁶ Case C-9/56 *Meroni v High Authority ECSC*, EU:C:1958:7.

conditions, technical and regulatory issues requiring regional coordination, in particular those concerning the implementation of network codes and guidelines, such as the CACM. The Contested Decision covers the technical and regulatory issues of the RDCTCS, requiring regional coordination at Core level, under the clearly specified conditions of Article 74 CACM.

1152. The Contested Decision is not a generally applicable normative decision. It is an individual decision addressed to All Core TSOs, which ACER was required to take, in strictly circumscribed circumstances (*in casu*, the referral by All Core NRAs under Article 9(11) CACM), in accordance with Article 6(10) of the ACER Regulation.
1153. The CJEU's case-law in *ESMA* upheld the *Meroni*-doctrine but qualified it, precisely to tackle the delegation of powers to European agencies in the context of the Treaty of Lisbon, which introduced full judicial control over such agencies³²⁷. In essence, in *Meroni* - which only dealt with entities governed by private law, as opposed to European agencies - the CJEU differentiated between clearly defined executive powers, which can be conferred, and discretionary powers, which cannot be conferred. *ESMA* qualified *Meroni* in that powers can be delegated to European agencies if the exercise of these powers is circumscribed by various conditions and criteria which limit their discretion and are precisely delineated and amenable to judicial review in the light of the objectives established by the delegating authority³²⁸.
1154. ACER's powers to adopt the Contested Decision fit within *ESMA*: ACER is a European agency as defined by Article 263 TFEU and exercised the powers that were conferred upon ACER in Article 6(10) ACER Regulation, following a referral by All Core NRAs under Article 9(11) CACM and in accordance with Article 74 CACM, referring to the general principles of Article 16 ER. ACER's competence to adopt the RDCTCS is, hence, subject to strict requirements of the ACER Regulation, the CACM and the ER. Furthermore, ACER is bound by a strict timeline of 6 months as per Articles 6(12) ACER Regulation and Article 9(11) CACM. Also, ACER would not have been able to adopt the Contested Decision without the favourable opinion of the BoR, requiring a two-thirds majority within the said Board, composed of All NRAs. As per Articles 28 and 29 ACER Regulation, the Contested Decision is amenable to judicial review by the Board of Appeal and the EU courts, in the light of the objectives established by the European Commission in the CACM, implementing the objectives established by the EU legislator in the ER.
1155. ACER did not expand its powers or bestow powers. ACER duly carried out its regulatory supervision of the RDCTCS in order to ensure compliance with the applicable regulatory framework. It did not act on the basis of policy goals or beliefs, as alleged by Appellant VI. ACER acted within the boundaries of the principle of proportionality and took the measures that were necessary and suitable to attain the objectives of the CACM, *inter alia*, contributing to the efficient long-term operation and development of the electricity transmission system and electricity sector in the Union (Article 3(g) CACM) and to "facilitate the efficient long-term development and operation of the pan-European interconnected system and the efficient operation of the pan-European electricity market (Article 74(6)(e) CACM), in line with the principles of the ER, *inter alia*, "network congestion problems shall be addressed with non-discriminatory market-based solutions which give efficient economic signals to the market participants and transmission system operators involved (Article 16(1) ER) and Article 16(13) ER, "When allocating costs of remedial actions between transmission system operators, regulatory authorities shall analyse to what extent flows resulting from transactions internal to bidding zones contribute to the congestion between two bidding zones observed, and allocate the costs based on the contribution to the congestion to the transmission system operators of the bidding zones creating such flows except for costs induced by flows resulting from transactions internal to bidding zones that are below the level

³²⁷ Article 263 TFEU stipulates that the Union bodies whose acts may be subject to judicial review by the European Courts include the "bodies, offices and agencies of the Union". Article 265 TFEU provides that the rules governing actions for failure to act apply to agencies. Article 267 TFEU provides that the courts and tribunals of the EU Member States may refer questions concerning the validity and interpretation of the agencies' acts to the European Courts. Article 277 TFEU provides that the agencies' acts may be subject to a plea of illegality.

³²⁸ Case C-270/12 *United Kingdom v European Parliament and Council*, EU:C:2014:18, paras 43, 45 and 53.

that could be expected without structural congestion in a bidding zone. That level shall be jointly analysed and defined by all transmission system operators in a capacity calculation region for each individual bidding zone border, and shall be subject to the approval of all regulatory authorities in the capacity calculation region.”

1156. Recital (23) CACM states that “any costs incurred efficiently to guarantee firmness of capacity and to set up processes to comply with this Regulation should be recovered via network tariffs or appropriate mechanisms in a timely manner”. Recital (25) CACM states that “the cooperation between TSOs, NEMOs and regulatory authorities is necessary in order to promote the completion and efficient functioning of the internal market in electricity and to ensure the optimal management, coordinated operation and sound technical development of the electricity transmission system in the Union”.
1157. As set out above in the First Consolidated Plea, the scope of the RDCTCS complies with Article 74(6)(c) CACM requiring “a fair distribution of costs and benefits between the TSOs involved”.
1158. ACER did not fill an alleged gap in the ER. ACER adopted the Contested Decision on the basis of Article 6(10)(a) ACER Regulation and, to this end, it carried out the regulatory supervision of All Core TSOs’ RDCTCS Proposal under Article 74 CACM, which stipulates in Article 74(6)(f) that the RDCTCS needs to facilitate adherence to the general principles of CM as set out in Article 16 ER. Article 16 ER contains general principles of CA and CM, *inter alia*, Article 16(13). The requirement in Article 74 CACM that the RDCTCS should facilitate adherence to the general principles of CM of Article 16 ER does not entail that the scope of the RDCTCS is limited to the CCMs. It merely requires the RDCTCS, which according to Article 74(4) CACM has to cover at least costs stemming from CCMs, to be in accordance with the general principles of CM of Article 16 ER. Nor does it entail that the RDCTCS should omit compliance with Article 74(2) CACM, which requires the RDCTCS to include solutions for actions of CB relevance. Furthermore, the general principles of CA and CM of Article 16 ER also contain Article 16(1) ER, which stipulates that TSOs need to take into account the effect of operational CM measures on neighbouring control areas and coordinate such measures with other affected TSOs as provided for in the CACM. Both Article 16(1) ER and Article 74 of the CACM require the RDCTCS to provide a non-discriminatory solution giving efficient economic signals to the market participants and TSOs involved, which, as demonstrated in the First Consolidated Plea, required the definition of XNEs set out in the Contested Decision’s RDCTCS.
1159. Appellant VI claims that the textual wording of Article 16(13) and 2(4) ER did not allow ACER to adopt the Contested Decision’s RDCTCS’ scope. It refers to Recital (9) ER: “Regulatory frameworks have developed, allowing electricity to be traded across the Union. That development has been supported by the adoption of several network codes and guidelines for the integration of the electricity markets. Those network codes and guidelines contain provisions on market rules, system operation and network connection. To ensure full transparency and increase legal certainty, the main principles of market functioning and capacity allocation in the balancing, intraday, day-ahead and forward market timeframes should also be adopted pursuant to the ordinary legislative procedure and incorporated in a Union legislative single act.” It also refers to Recital (16) ER: “Commission Regulation (EU) 2015/1222 (7) sets out detailed guidelines on cross-zonal capacity allocation and congestion management in the day-ahead and intraday markets, including the requirements for the establishment of common methodologies for determining the volumes of capacity simultaneously available between bidding zones, criteria to assess efficiency and a review process for defining bidding zones. Articles 32 and 34 of Regulation (EU) 2015/1222 set out rules on review of bidding zone configuration, Articles 41 and 54 thereof set out harmonised limits on maximum and minimum clearing prices for day-ahead and intraday timeframes, Article 59 thereof sets out rules on intraday cross-zonal gate closure times, whereas Article 74 thereof sets out rules on redispatching and countertrading cost sharing methodologies.” It furthermore refers to Recital (35) ER: “In an open, competitive market, transmission system operators should be compensated for costs incurred as a result of hosting cross-border flows of electricity on their networks by the operators of the transmission systems from which cross-border flows originate and the systems where those flows end.”.
1160. The Contested Decision’s RDCTCS neither infringes Article 16(13) ER nor Article 2(4) ER, as demonstrated in the First Consolidated Plea. The textual wording of Article 16(13) ER does not limit the application of the PPP exclusively to congestions between 2 BZs. It does not impede the application of the PPP to other congestions than congestions between 2 BZs. It simply requires the application of the PPP to congestions between 2 BZs. A literal

interpretation of Article 16(13) ER specifies the elements of a cost sharing solution for congestions between 2 BZs observed but it does not contain any prohibition regarding the adoption of a other cost sharing solutions. Moreover, as set out in the First Consolidated Plea, the application of the PPP to the full scope of the RDCTCS is confirmed by contextual, teleological and historic interpretations, which require the RDCTCS to apply the PPP to the full scope of XNEs³²⁹.

1161. Recital (9) ER clarifies that the ER sets out the main principles of the functioning of the internal electricity market which, according to Recital (8) ER, requires increased efforts to coordinate national energy policies with neighbours and to use opportunities of CB electricity trade.
1162. Recital (16) ER contains a referral by the ER to the CACM, including Article 74 thereof, setting rules on RDCTCS.
1163. As to Recital (35) ER, it states that TSOs have to be compensated for costs deriving from hosting CB flows on their NEs by the TSOs causing these flows. It reinforces the correct interpretation of the PPP whereby TSOs causing polluting flows need to bear the costs as opposed to TSOs hosting polluting flows. As has been set out in the First and Eighth Consolidated Pleas, ACER correctly applied the PPP of Article 16(13) ER when adopting the Contested Decision's RDCTCS.
1164. Appellant VI lists the successive drafts of Article 14 to 16 ER³³⁰ and establishes that it does not contain any provision stipulating that ACER should be granted new powers to revise the ER. At the Oral Hearing, Appellant VI held that ACER does not have the powers effectively to rewrite the terms of a European Regulation adopted by the Council and the European Parliament in 2019. Nor can ACER simply ignore or side-step the literal wording of the Regulation when adopting a TCM such as the contested methodology.
1165. ACER's powers are, as set out above, defined by the ACER Regulation. Furthermore, ACER did not revise the ER: it adopted the Contested Decision's RDCTCS ensuring compliance with Article 74 CACM, which requires the RDCTCS to facilitate adherence to the general principles of CM set out in Article 16 ER.
1166. Appellant VI also establishes that the successive drafts of Article 14 to 16 ER do not contain an indication that costs to be covered by the RDCTCS should include costs originating from congestions within BZs.
1167. The Board of Appeal notes that the ER is the legal basis of the CACM. The ER is not the legal basis of the RDCTCS, which is contained in Article 74 CACM. The ER contains general principles of CM, the adherence to which has to be facilitated by the RDCTCS. Using deductive logics in relation to the legal basis of the applicable normative framework is void: each norm has its own legal basis. It is legally flawed to state that, because the CACM is based on Article 18(3)(b) and (5) Old ER and because Article 74 CACM is the legal basis of the RDCTCS, Article 18(3)(b) and (5) Old ER is also the legal basis of the RDCTCS. Arguing so leads to an incorrect interpretation of the applicable normative framework. The RDCTCS needs to comply with the ER within the boundaries of its scope, which is defined by the CACM.

³²⁹ H.G. Schermes, D.F. Waelbroeck, "Judicial Protection in the European Union" (2001); N. Fennelly, "Legal Interpretation at the European Court of Justice", Fordham International Law Journal Volume 20, Issue 3 1996; A. Albors Llorens, "The European Court of Justice, More than a Teleological Court", Cambridge University Press, 2017;; Case 26/62 *Van Gend en Loos* ECLI:EU:C:1963:1; Case 6/64 *Costa v. ENEL* ECLI:EU:C:1964:66; Case 26/69 *Stauder v Ulm*, ECLI:EU:C:1969:57; Case 55/87 *Moksel v. BALM*, ECLI:EU:C:1988:377; Case C-89/81 *Hong Kong Trade*, ECLI:EU:C:1982:121; Case C-101/01 *Lindqvist* ECLI:EU:C:2003:596; Case C-409/06 *Winner Wette* ECLI:EU:C:2010:503; Case C-402/07 *Sturgeon and Others*, ECLI:EU:C:2009:716; Case C-439/08 *VEBIC* ECLI:EU:C:2010:739; Case C-41/09 *European Commission and Kingdom of the Netherlands*, ECLI:EU:C:2011:108; Joined Cases C-188/10 and C-189/10 *Melki and Abdeli* ECLI:EU:C:2010:363; Case C-583/11 *P Inuit Tapiriit Kanatami and Others*, ECLI:EU:C:2013:625.

³³⁰ Annex A.5.4 to Appeal VI.

1168. The legal basis of the CACM is, as correctly stated by Appellant IV, Article 18(3)(b) and (5) Old ER. Article 18(3)(b) Old ER states: “Where appropriate, Guidelines providing the minimum degree of harmonisation required to achieve the aim of this Regulation shall also specify (...) (b) details of rules for the trading of electricity”. Article 18(5) Old ER states: “The Commission may adopt Guidelines on the issues listed in paragraphs 1, 2 and 3 of this Article. (...) When adopting or amending Guidelines, the Commission shall (a) ensure that the Guidelines provide the minimum degree of harmonisation required to achieve the aims of this Regulation and do not go beyond what is necessary for that purpose; and (b) indicate what actions it has taken with respect to the conformity of rules in third countries, which form part of the Community electricity system, with the Guidelines in question.(..)”
1169. Article 18(3) Old ER classifies implementing guidelines in 4 categories: (a) TSOs’ coordination and information exchange mechanisms, (b) rules for electricity trading, (c) investment incentive rules for interconnector capacity and (d) ENTSO-E network codes. The CACM does not fit within category (a), (c) or (d) but fits within category (b): electricity trading. Electricity trading is, however, to be interpreted in the context of the goals that the Old ER aimed to achieve with the harmonisation through CACM. These aims are set out in Article 1 Old ER states that it is aimed at “(a) setting fair rules for cross-border exchanges in electricity, thus enhancing competition within the internal market in electricity, taking into account the particular characteristics of national and regional markets. This will involve the establishment of a compensation mechanism for cross-border flows of electricity and the setting of harmonised principles on cross-border transmission charges and the allocation of available capacities of interconnections between national transmission systems; and (b) facilitating the emergence of a well-functioning and transparent wholesale market with a high level of security of supply in electricity. It provides for mechanisms to harmonise the rules for cross-border exchanges in electricity.”
1170. The aims set out in Article 1 ER similarly state that it aims to “(a) set the basis for an efficient achievement of the objectives of the Energy Union and in particular the climate and energy framework for 2030 by enabling market signals to be delivered for increased efficiency, higher share of renewable energy sources, security of supply, flexibility, sustainability, decarbonisation and innovation; (b) set fundamental principles for well-functioning, integrated electricity markets, which allow all resource providers and electricity customers non-discriminatory market access, empower consumers, ensure competitiveness on the global market as well as demand response, energy storage and energy efficiency, and facilitate aggregation of distributed demand and supply, and enable market and sectoral integration and market-based remuneration of electricity generated from renewable sources; (c) set fair rules for cross-border exchanges in electricity, thus enhancing competition within the internal market for electricity, taking into account the particular characteristics of national and regional markets, including the establishment of a compensation mechanism for cross-border flows of electricity, the setting of harmonised principles on cross-border transmission charges and the allocation of available capacities of interconnections between national transmission systems; and (d) facilitate the emergence of a well-functioning and transparent wholesale market, contributing to a high level of security of electricity supply, and provide for mechanisms to harmonise the rules for cross-border exchanges in electricity.”
1177. The ER aims at facilitating the emergence of a well-functioning and transparent wholesale market, contributing to a high level of security of electricity supply, and provide for mechanisms to harmonise the rules for CB exchange in electricity. The Board of Appeal refers to the First Consolidated Plea, Sub-Plea 1.1.4, which emphasizes that ensuring OS underpins the objectives of the CACM and the ER.
1178. In the light of the objectives of the Old ER and the currently applicable ER, the CACM’s harmonisation is aimed at the achievement of the internal electricity market, including necessary cost sharing rules to achieve said goal.
1179. The Contested Decision has been adopted on the basis of the CACM, which harmonises electricity trading to achieve an internal electricity market, in particular Article 74 CACM, which mandates the creation of the RDCTCS. Given the ultimate aim of the ER, the wording “electricity trading” cannot be interpreted to reduce the scope of the RDCTCS under Article 74 CACM to the CC scope. As Appellant IV correctly states, Article 1 ER demonstrates that the CACM addresses issues of CB relevance. This is in line with Article 74(2) CACM, which requires the RDCTCS to provide “cost-sharing solutions for actions of cross-border relevance.” and with the scope of the Contested Decision’s RDCTCS covering XNEs, as set out in the First Consolidated Plea.

1180. Appellant IV refers to Article 74(4)(b) CACM, which states that the RDCTCS “shall at least define which costs incurred from using redispatching or countertrading to guarantee the firmness of cross-zonal capacity are eligible for sharing between all the TSOs of a capacity calculation region in accordance with the capacity calculation methodology set out in Articles 20 and 21”.
1181. The Board of Appeal notes that Article 74(4)(b) CACM establishes that the RDCTCS should cover at least costs incurred from CCMs, but does not prevent the inclusion of costs on other XNEs.
1182. The Board of Appeal observes that Cases T-332/17 E-Control and T-333/17 Austrian Power Grid & others, quoted by Appellant VI, stress that, when there is a joint request by the NRAs – as in the present case – there is no doubt about the conferral of powers by the NRAs to ACER: “By contrast, ACER is competent to decide on a common proposal from the TSOs where, despite the existence of an amendment request, the national regulatory authorities confer on that agency, under Article 9(11) of Regulation 2015/1222, by means of a joint request, the task of approving the common proposal initially submitted by the TSOs or where, if no such amendment request has been submitted, those national authorities unanimously choose to shorten the period of 6 months referred to in Article 9(10) of that regulation”³³¹. In that case, the GCEU stated, *a contrario*, that ACER is competent to rely upon effectiveness if there is real need to ensure the practical effect of the provisions of the Treaties or the regulation concerned, namely a need which is such as to justify the existence of an implicit decision-making power and, accordingly, a derogation from the principle of conferral set down in Article 5(2) TEU³³².
1183. In earlier BoA Decision A-001-2017, quoted by Appellant VI, the issue at stake was whether the trigger for a referral to ACER (which can either be a failure to agree by NRAs or a joint referral by NRAs) had any impact on ACER’s possibility to amend TSOs’ proposals. The Board of Appeal refers to paragraph 67 of BoA Decision A-001-2017: “In such circumstances, if the Agency had no discretion to modify the TSOs’ proposal and was compelled to request an amendment, the decision-making process could become inefficient if the NRAs and/or TSOs were not willing to reach an agreement, since, as noted by the European Commission in its letter dated 4 July 2016, the proposals could go back and forth many times, causing significant delays or a stalemate.”³³³ This is not the case here: Appellants do not question that ACER has the power to amend All Core TSOs’ RDCTCS Proposal following All Core NRAs’ referral due to a failure to reach an agreement.
1184. Appellant VI alleges that in an earlier draft of the Contested Decision of September 2020³³⁴, the RDCTCS was different from the alleged excessive scope of the RDCTCS.
1185. The Board of Appeal highlights that this demonstrates precisely that the decision-making process leading-up to the Contested Decision is a market-driven, bottom-up, gradual, step-based and multipartite process, in which, at different points in time, various national and EU stakeholders are called on to participate and whereby all stakeholders involved exchange opinions and provide input to attain an optimal solution that ensures compliance with the applicable regulatory framework. ACER’s powers have to be situated within this decision-making process. The Contested Decision is the outcome of ACER’s decision-making process, including an extensive consultation process with All Core TSOs and All Core NRAs, the involvement of ACER’s AEWG and ACER’s BoR (composed of All NRAs), two-thirds of which decide on whether ACER’s draft decision is to be approved. ACER is an agency that is meant to promote cooperation between NRAs.
1186. Appellant V alleges similarly that the CACM is an implementing act of the ER and may, therefore, not amend or supplement the ER, as this would violate Article 291 TFEU. This, in its view, limits the RDCTCS scope to electricity trading, which depends on the existence of sufficient CZC and the lack of congestion.

³³¹ Case T-332/17 E-Control v ACER of 24 October 2019, ECLI:EU:T:2019:761, para 46. Case T-333/17 Austrian Power Grid AG and Vorarlberger Übertragungsnetz GmbH v ACER of 24 October 2019, ECLI:EU:T:2019:760, para 55.

³³² See also, T-240/04 *France v Commission*, EU:T:2007:290, paragraph 37.

³³³ Annex A.7.4, p. 950.

³³⁴ Annex A.2.2 of Appeal VI.

1187. It refers to Recital (3) CACM, which reads as follows: “Regulation (EC) No 714/2009 sets out non-discriminatory rules for access conditions to the network for cross-border exchanges in electricity and, in particular, rules on capacity allocation and congestion management for interconnections and transmission systems affecting cross-border electricity flows. In order to move towards a genuinely integrated electricity market, the current rules on capacity allocation, congestion management and trade in electricity should be further harmonised. This Regulation therefore sets out minimum harmonised rules for the ultimately single day-ahead and intraday coupling, in order to provide a clear legal framework for an efficient and modern capacity allocation and congestion management system, facilitating Union-wide trade in electricity, allowing more efficient use of the network and increasing competition, for the benefit of consumers.”
1188. The limitation of the RDCTCS’ scope to the scope of the CCMs is flawed, as set out above in this Sub-plea and in the First Consolidated Plea. As to Recital (3) CACM, it confirms that the CACM is an implementing act of the ER, aimed at the achievement of the internal electricity market, including necessary cost sharing rules to achieve said goal.
1189. Article 291 TFEU reads as follows: “1. Member States shall adopt all measures of national law necessary to implement legally binding Union acts. 2. Where uniform conditions for implementing legally binding Union acts are needed, those acts shall confer implementing powers on the Commission, or, in duly justified specific cases and in the cases provided for in Articles 24 and 26 of the Treaty on European Union, on the Council. 3. For the purposes of paragraph 2, the European Parliament and the Council, acting by means of regulations in accordance with the ordinary legislative procedure, shall lay down in advance the rules and general principles concerning mechanisms for control by Member States of the Commission’s exercise of implementing powers. 4. The word “implementing” shall be inserted in the title of implementing acts.”
1190. In *ESMA*³³⁵, the CJEU held that (i) the nature of decisions of EU agencies is different and does not correspond with the situation defined in Article 291 TFEU and that (ii) the regulations governing EU agencies do not undermine the rules governing the delegation of powers of Article 291 TFEU. It added, that these regulations “vest” EU agencies “with certain decision-making powers in an area which requires the deployment of specific technical and professional expertise” and “cannot be considered in isolation” (in the case of ESMA, Regulation 236/2012 had to “be perceived as forming part of a series of rules designed to endow the competent national authorities and ESMA with powers of intervention to cope with adverse developments which threaten financial stability within the Union and market confidence. To that end, those authorities must be in a position to impose temporary restrictions on the short selling of certain stocks, credit default swaps or other transactions in order to prevent an uncontrolled fall in the price of those instruments. **Those bodies have a high degree of professional expertise and work closely together in the pursuit of the objective of financial stability within the Union**”. (emphasis added)
1191. By analogy, when exercising its competences under Article 6(10) ACER Regulation, ACER is vested with certain decision-making powers in areas which require the development of specific technical and professional expertise, which do not have to be considered in isolation but in conjunction with the CACM and ER and do not undermine the delegation of powers under Article 291 TFEU.

14.2 Threshold for acceptable loop flows.

1192. Appellant III³³⁶ claims that there was no legal basis for ACER to set a common LF threshold neither in CACM nor in ER. It also claims that ACER was not the competent authority to decide on the threshold for legitimate LFs because Article 16(13) ER explicitly puts the NRAs in charge of deciding upon an individual LF threshold for each BZB. Also, this interim threshold set by ACER bears, in its view, the threat of permanently undermining the NRAs’ competences because Article 16(13) ER does not set any timing for TSOs and NRAs to determine the individual LF thresholds.
1193. Appellant IV³³⁷ claims that ACER infringed the principle of conferral of Article 5(1) and (2) TEU when determining the common threshold for acceptable LFs in Article 7 of the Contested Decision’s RDCTCS. In Appellant IV’s view, Article 16(13) ER expressly states

³³⁵ Case C-270/12 *United Kingdom v European Parliament and Council*, EU:C:2014:18, paras 77 to 87.

³³⁶ Appeal III, Plea 2, paras 134-139.

³³⁷ Appeal IV, Plea 3, para 116.

that the competence to approve All Core TSOs' proposal for a legitimate LF threshold is a competence of All Core NRAs. ACER lacks, in its view, the competence to determine any LF threshold.

1194. Appellant V³³⁸ claims that ACER is precluded from setting a common 10%-threshold in a way that infringes Article 16(8) ER and the principle of proportionality without corresponding competence and technical reasons. Appellant V claims that the temporary threshold set by ACER (i) does not rely on factually accurate, reliable and consistent evidence, (ii) relies on evidence that does not contain all information that had to be taken into account in order to assess a complex situation and (iii) insufficiently substantiates the conclusion drawn from the evidence.
1195. Appellant VI³³⁹ claims that ACER exceeded its competence to implement a delegated measure, namely an implementing act (CACM), as defined in Article 291 TFEU, by supplementing the principles of cost allocation provided for in the CACM instead of ensuring its uniform application. Appellant VI alleges that ACER has no power under CACM to impose a general threshold for penalising polluting flows as there is no legal basis for the imposition of such a threshold by ACER. This power is, in its view, the responsibility of All Core TSOs.
1196. The Defence³⁴⁰ responds that ACER was competent to adopt the Contested Decision under Articles 5(3) and 6(10) ACER Regulation. It also replies that ACER was competent to set a common threshold and did not breach the principle of conferral.
1197. Articles 5(1) and (2) TEU are quoted in Sub-Plea 14.1.
1198. As set out above in the Seventh Consolidated Plea, ACER set a threshold for acceptable LFs to carry out its duty of regulatory approval of All Core TSOs' RDCTCS Proposal as per Article 6(10) of the ACER Regulation, given the impossibility of All Core NRAs' to reach an agreement within the set deadline under Article 9(11) CACM.
1199. ACER took the Contested Decision on the basis of Article 6(10) of the ACER Regulation. That is the legal basis of the Contested Decision, including the RDCTCS in its Annex 1 and, more specifically, Article 7 on the Distribution of costs on XNECs to TSOs, where a common threshold for acceptable LFs of 10% is temporarily determined. The Contested Decision is not silent on the legal basis: Section 3 of the Contested Decision entitled "*ACER's competence to decide on the Proposal*", in paragraphs 12 to 18 of the Contested Decision, sets out the legal basis for the Contested Decision.
1200. ACER did not exceed its competence. ACER's competence has to be situated in a bottom-up decision-making process foreseen by EU energy regulation. In this bottom-up decision-making process, the role of the regulators – either the NRAs or ACER – is to assess whether TSO proposals comply with the applicable regulatory framework in order to subsequently grant regulatory approval.
1201. ACER carried out the regulatory supervision of All Core TSOs' RDCTCS Proposal under the CACM which had been referred to it by All NRAs in accordance with the CACM's referral procedure.
1202. ACER did not bestow additional powers on itself beyond the powers conferred by the ACER Regulation. It exercised the powers that it was under an obligation to exercise in accordance with Article 9(11) of the CACM and Article 5(3) ACER Regulation and Article 6(10) of the ACER Regulation.
1203. Indeed, the bottom-up decision-making process provides that the initiative comes from the market (TSOs) but is supervised by regulatory authorities (NRAs or ACER) to ensure adequate regulatory compliance by private companies having private interests, in particular on CB issues. In the present case, All Core NRAs referred decision-making on All Core TSOs'

³³⁸Appeal V, Plea 3, para 196 and paras 206-213.

³³⁹Appeal VI, Plea 2, paras 125-151.

³⁴⁰Defence, paras 188-202, 437-456.

RDCTCS Proposal to ACER on the basis of Article 9(11) CACM: *“Where the regulatory authorities have not been able to reach agreement within the period referred to in paragraph 10, or upon their joint request, the Agency shall adopt a decision concerning the submitted proposals for terms and conditions or methodologies within six months, in accordance with Article 8(1) of Regulation (EC) No 713/2009.”*

1204. Given that All Core TSOs’ RDCTCS Proposal did not contain a legitimate LF threshold as required by Article 16(13) ER, ACER had to ensure compliance with Article 74(6)(f) CACM and Article 16(13) ER, as set out in the Seventh Consolidated Plea.
1205. Article 16(13) ER requires that the legitimate LF threshold *“shall be jointly analysed and defined by all transmission system operators in a capacity calculation region for each individual bidding zone border, and shall be subject to the approval of all regulatory authorities in the capacity calculation region”*.
1206. ACER therefore asked All Core TSOs to set the legitimate LF threshold required by Article 16(13) ER in a 4 month deadline but, in the absence of compliance by All Core TSOs, it was under a duty to ensure compliance with Article 16(13) ER and therefore determined a temporary common threshold for legitimate LFs in the amount of 10%, following a rigorous analysis of the results from All Core TSOs’ Experimentation Report, All Core TSOs’ Non-Paper, All Core NRAs’ Non-Paper and the results from ACER’s own simulations using a variety of parameters. The Contested Decision’s RDCTCS clarifies that this threshold is temporary and will automatically be replaced by a new threshold commonly determined by All Core TSOs and approved by All Core NRAs.
1207. ACER duly exercised its powers in accordance with the principle of subsidiarity and proportionality. As was set out in the Eleventh Consolidated Plea, a common threshold for legitimate LFs is not only necessary but suitable to attain the objectives of the applicable regulatory framework.
1208. Given the indispensability of a LF threshold in order to create the RDCTCS as mandated by the CACM, and to also ensure compliance with the ER, in particular Article 16(13)ER, the Contested Decision had to contain a threshold for legitimate LFs.
1209. In the absence of a threshold for legitimate LFs, the Contested Decision’s RDCTCS could not have ensured compliance with the Article 74(6)(b) CACM, which requires the RDCTCS to *“be consistent with the responsibilities and liabilities of the TSOs involved”*. All Core TSOs had the responsibility to determine a threshold for legitimate LFs. The absence of an agreement forced ACER to determine a temporary LF threshold that would disappear as soon as All Core TSOs would determine a definitive LF threshold (which All Core TSOs could do prior to the implementation of the RDCTCS in order to avoid that ACER’s temporary LF threshold by used at all).
1210. In the absence of a threshold for legitimate LFs, the Contested Decision’s RDCTCS could not have ensured compliance with Article 74(6)(e) CACM, requiring the RDCTCS to *“facilitate the efficient long-term development and operation of the pan-European interconnected system and the efficient operation of the pan-European electricity market”*. Both the efficient long-term development and operation of the EU interconnected system and the efficient operation of the EU electricity market require that the costs of RDCT actions be shared at a regional level among TSOs through a cost sharing solution. And a legitimate LF threshold is indispensable in order to create a RDCTCS in line with the PPP, as mandated by the ER.
1211. In the absence of a threshold for legitimate LFs, the Contested Decision’s RDCTCS could not have ensured compliance with the Article 74(6)(f) CACM, which requires the RDCTCS to *“facilitate adherence to the general principles of congestion management as set out in Article 16 ER”*. Article 16(13) ER expressly requires that a *“level”* is set below which structural congestion can be expected in a BZ. Given that All Core TSOs had not (yet) reached an agreement on the legitimate LF threshold, ACER was under a regulatory obligation to set a temporary LF threshold in order to ensure compliance with the CACM and the ER. The absence of the temporary LF threshold set by ACER would have thwarted the application of the PPP, at the

heart of the cost sharing methodology of the RDCTCS. The PPP is at the heart of the cost sharing methodology of the RDCTCS³⁴¹.

1212. The absence of the temporary LF threshold set by ACER would also have jeopardised the *effet utile* of Article 74 CACM, given that the threshold for legitimate LFs is as an indispensable part of the RDCTCS, as expressly recognised by the Contested Decision. Paragraph 109 of the Contested Decision states: “*The threshold for loop flows is an indispensable part of the cost sharing methodology, because Article 16(13) of the Electricity Regulation establishes a principle by which loop flows, which are expected in bidding zones without structural congestions should not be considered as contributing to congestion and therefore penalised. This principle reflects the fundamental nature of zonal electricity market model that even in an optimal bidding zone configuration, some levels of loop flows would still persist and are therefore inherent in any zonal market model. Article 16(13) of the Electricity Regulation therefore establishes a rule by which this normal level of loop flows is legitimate and should not be penalised.*”
1213. The need for such a threshold was acknowledged by All Core TSOs in Article 8 of All Core TSOs’ RDCTCS Proposal. The Explanatory Document to All Core TSOs’ RDCTCS Proposal³⁴² demonstrates that All Core TSOs unanimously agreed on a LF threshold in Section 4.5 and that the discussion merely related to the parameters of the threshold:
“*4.5.1 Treatment of loop flow.*
Loop flows are unscheduled flows and make use of cross-border capacity (indirectly) prior to the Market Flows. For the prioritisation of the different flows identified by the flow decomposition methodology, burdening loop flows are seen as the most critical flows. In accordance with the ACER recommendation and to avoid free-riding of neighbouring countries, those flows should be penalised in the first place in case a XBRNE is overloaded¹⁵. Therefore loop flows are considered as polluters. They are also, individually, associated with only one bidding zone.
The electricity network of the Core CCR is highly meshed and in combination with the zonal design of the EU Internal Energy Market a certain level of loop flows is therefore inevitable, even with the most ambitious grid investments. Indeed, such a goal could lead to the target which could be opposite to the goals of internal electricity market (lower investments in cross-border lines). Due to these reasons a threshold for the loop flows could be considered. The consequence of applying a threshold is that a part of the loop flows gets accepted and gets less highly prioritised as the remaining bigger share. This option leads to the following questions:
On what parameter does the threshold apply?
(For the sake of clarity, please find an example in order to grasp the difference between the two possible options or parameters.)(..)”
1214. Similarly, All Core NRAs unanimously agreed on the need for a LF threshold in All Core NRAs’ Non-Paper, Section 2.3. The debate was not on whether to have a threshold but what the scope of application of the threshold had to be³⁴³: “*In short, all Core NRAs agree that the flows below the defined threshold should be borne by the TSO responsible for the area to which the congested network element belongs.*”
1215. In their Non-Paper (Section 1.9, “*Loop Flow Threshold*”), all Core TSOs also unanimously agreed on the need for a LF threshold³⁴⁴: “*In accordance with article 16(13) of REGULATION (EU) 2019/943, TSOs have to define the acceptable level of flows resulting from transactions internal to bidding zones. This level of acceptable loop flow is defined by a loop flow threshold.*”. The debate was centred on the modalities of such threshold.
1216. In the absence of ACER’s determination of a temporary threshold for legitimate LFs, a deadlock situation could have occurred whereby the inability for All Core TSOs to reach an agreement could have led to the consequence that no adequate RDCTCS could have been implemented.
1217. ACER had two options when it faced a lack of compliance of All Core TSOs’ RDCTCS Proposal with the requirements of Article 16(3) ER: either to specify a legitimate LF threshold itself or instead to require All Core TSOs propose to specify a legitimate LF threshold. ACER chose the latter, in line with the principle of proportionality, and asked All Core TSOs to specify a legitimate LF threshold within a 4-month deadline, which was

³⁴¹ See Contested Decision, para 109. See also, ACER’s Defence, e.g. paras 447-448, 450, 462 and 467.

³⁴² Annex 13 to the Defence, p. 45.

³⁴³ Annex A.3.2 to Appeal VI.

³⁴⁴ Annex 79 to the Defence.

reasonable to enable ACER to subsequently supervise its compliance with the applicable regulatory framework and approve it. However, in the absence of an agreement between All Core TSOs, ACER was under a duty to ensure that the RDCTCS complied with the applicable regulatory framework, including Article 16(13) ER and contained a legitimate LF threshold. It therefore determined a temporary common threshold for acceptable LFs in the amount of 10%, following a rigorous analysis of the results from All Core TSOs' Experimentation Report, All Core TSOs' Non-Paper, All Core NRAs' Non-Paper and the results from ACER's own simulations using a variety of parameters. The Contested Decision's RDCTCS clarifies that this threshold is temporary and will automatically be replaced by a new threshold commonly determined by All Core TSOs and approved by All Core NRAs. The Contested Decision's RDCTCS does not set any time restrictions upon Core TSOs and NRAs to adopt a definitive legitimate LF threshold replacing the temporary threshold of the Contested Decision's RDCTCS. This implies that All Core TSOs and NRAs could adopt a definitive legitimate LF threshold before the actual implementation of the RDCTCS and avoid the implementation of the temporary threshold all in all.

1218. In other terms, ACER left it up to All Core TSOs to determine the legitimate LF threshold but, in the absence of such timely determination, ensured an interim solution in order not to jeopardise the implementation of the RDCTCS and, what is more, the implementation of the interim solution could still be avoided by All Core TSOs as soon as they would agree on a definitive legitimate LF threshold to replace ACER's temporary threshold. All Core TSOs' could even agree to determine a legitimate LF threshold before the implementation of the RDCTCS in order to avoid any use of ACER's temporary threshold at all.
1219. The Board of Appeal refers by analogy to similar Case A-008-2020 relating to the Imbalance Netting Implementation Framework (INIF)³⁴⁵, where, given the lack of compliance of All TSOs' 4th INIF Proposal with the requirement to either clearly state whether it proposed to designate, on the one hand, the same entity as the Imbalance Netting Process Function (INPF)/TSO-TSO Settlement Function (TTSF) entity for the Capacity Management Function (CMF) entity or, on the other hand, a different CMF entity, ensuring and demonstrating compliance with the additional requirements of Article 22(3)(e) of Regulation (EU) 2017/2195 (EBGL), ACER inserted the obligation upon All TSOs to designate a CMF entity within a reasonable period of 2 and a half years, leaving it up to the TSOs to decide whether this entity would be identical to the INPF/TTSF entity or different from the INPF/TTSF entity, as long as compliance with the additional requirements of Article 22(3)(e) of the EBGL was ensured and demonstrated if multiple entities were designated. In so doing, the Agency refrained from either setting additional conditions to bring All TSOs' 4th INIF Proposal in line with Article 22(3)(e) of the EBGL as regards the CMF or from designating the CMF entity itself. Instead, it allowed the TSOs to arrive at a solution they deemed most adequate, within the confines of the legal requirements, without adding any further conditions as to the entity to operate the CMF function.
1220. In a similar way as in A-008-2020³⁴⁶, the Contested Decision could not remain silent on the issue because such silence would have been contrary to the applicable regulatory framework.
1221. Appellant VI furthermore claims that ACER's powers are limited by Article 291 TFEU, because the European Commission had limited powers to introduce a minimum level of harmonisation through the CACM, when implementing the ER, specifically Article 16(13) ER, which mandates All Core TSOs to analyse and determine the legitimate LF threshold. Appellant VI quotes paragraph 68 of BoA Decision A-007-2020. This decision relates, however, to ACER's duty to reason³⁴⁷. Appellant VI also quotes Case C-88/14 *Visa*

³⁴⁵ Board of Appeal Decision A-008-2020, paras 229, 276 and 300.

³⁴⁶ Board of Appeal Decision A-008-2020, paras 188, 293 and 297.

³⁴⁷ Paragraph 68 of the Contested Decision states: *First, Article 36(3) of the ER mandates ACER to either approve ENTSO-E's SOR Proposal or to propose amendments to ENTSO-E's SOR Proposal pursuant to a consultation. In the*

*Reciprocity*³⁴⁸. This case relates to the exercise of implementing powers by the European Commission.

1222. Article 291 TFEU reads as follows: “1. Member States shall adopt all measures of national law necessary to implement legally binding Union acts. 2. Where uniform conditions for implementing legally binding Union acts are needed, those acts shall confer implementing powers on the Commission, or, in duly justified specific cases and in the cases provided for in Articles 24 and 26 of the Treaty on European Union, on the Council. 3. For the purposes of paragraph 2, the European Parliament and the Council, acting by means of regulations in accordance with the ordinary legislative procedure, shall lay down in advance the rules and general principles concerning mechanisms for control by Member States of the Commission's exercise of implementing powers. 4. The word "implementing" shall be inserted in the title of implementing acts.”
1223. In *ESMA*³⁴⁹, the CJEU held that (i) the nature of decisions of EU agencies is different and does not correspond with the situation defined in Article 291 TFEU and that (ii) the regulations governing EU agencies do not undermine the rules governing the delegation of powers of Article 291 TFEU. It added, that these regulations “vest” EU agencies “with certain decision-making powers in an area which requires the deployment of specific technical and professional expertise” and “cannot be considered in isolation” (in the case of ESMA, Regulation 236/2012 had to “be perceived as forming part of a series of rules designed to endow the competent national authorities and ESMA with powers of intervention to cope with adverse developments which threaten financial stability within the Union and market confidence. To that end, those authorities must be in a position to impose temporary restrictions on the short selling of certain stocks, credit default swaps or other transactions in order to prevent an uncontrolled fall in the price of those instruments. **Those bodies have a high degree of professional expertise and work closely together in the pursuit of the objective of financial stability within the Union**”. (emphasis added)
1224. By analogy, when exercising its competences under Article 6(10) ACER Regulation, ACER is vested with certain decision-making powers in areas which require the development of specific technical and professional expertise, which do not have to be considered in isolation but in conjunction with the CACM and ER, do not correspond with the situation defined in Article 291 TFEU but do not undermine the delegation of powers under Article 291 TFEU.
1225. Appellant VI also alleges that the ER is a regulation of direct application in the national legal borders of the EU Member States, and that EU Member States, including their NRAs, have no competence to amend the ER, specifically Article 16(13) ER, which mandates All Core TSOs to analyse and determine the legitimate LF threshold. In its opinion, given that NRAs do not have powers to amend the ER, ACER cannot have powers to amend the ER.
1226. ACER neither amended the ER nor exceeded its powers when applying Article 16(13) ER. As confirmed by the Board of Appeal in its earlier case-law, ACER does not exercise a delegated or derived competence from the NRAs³⁵⁰. It exercises a competence which is its own, granted to it by the EU legislator through the ACER Regulation, when the respective requisites are met. ACER’s competence to adopt the Contested Decision derives directly and immediately from Article 6(10) ACER Regulation. Yet, as noted in said case-law, ACER, as an EU agency, is required to interpret EU Law in a systematic approach and to observe the principle of sincere cooperation with the EU Member States, including the NRAs. The principle of sincere cooperation between ACER and the NRAs derives from Articles 4(3) and (13) TEU and are highlighted in Recitals (2), (4), (10), (16), (22), (23), (30) and 45 and Article 1 of the ACER Regulation. ACER is an agency that is meant to promote cooperation between NRAs. Article 1(2) and (3) ACER Regulation stipulates that ACER’s purpose is “2. to assist the regulatory authorities referred to in Article 57 of Directive (EU) 2019/944 and Article 39 of Directive

ER’s step-wise, bottom-up regional coordination process of electricity system operation, ACER was not required to reiterate the entire process ab initio but to either approve ENTSO-E’s SOR Proposal or to bring amendments that were necessary to ensure compliance with the applicable regulation. Accordingly, to the extent that it amended ENTSO-E’s SOR Proposal, the Agency had a duty to duly state the underlying reasons for these amendments.

³⁴⁸ Case C-88/14 *Visa Reciprocity*, ECLI:EU:C:2015:499.

³⁴⁹ Case C-270/12 *United Kingdom v European Parliament and Council*, EU:C:2014:18, paras 77 to 87.

³⁵⁰ BoA Decisions A-004-2019, paras 118 and 188; A-001-2020, paras 100, 104, 106, 109 and 115; A-002-2020, paras 100, 104, 106 and 109; and A-008-2020, para 139.

2009/73/EC in exercising, at Union level, the regulatory tasks performed in the Member States and, where necessary, to coordinate their action and to mediate and settle disagreements between them in accordance with Article 6(10) of this Regulation. ACER shall also contribute to the establishment of high-quality common regulatory and supervisory practices, thus contributing to the consistent, efficient and effective application of Union law in order to achieve the Union's climate and energy goals.” and that “3. When carrying out its tasks, ACER shall act independently, objectively, and in the interest of the Union. ACER shall take autonomous decisions, independently of private and corporate interests”. ACER coordinates NRAs’ actions and mediates and settles disagreements between NRAs. According to Article 22 ACER Regulation, ACER’s Director cannot adopt individual decision without a two-thirds majority of the BoR, composed of All NRAs. The principle of sincere cooperation explains why paragraph 73 of the Contested Decision states that: “During the proceedings on this Decision, ACER explored whether regulatory authorities could support the interpretation that only network elements concerned by the congestion as defined in Article 2(4) of the Electricity Regulation are eligible for cost sharing (as outlined in paragraph 67 above). The responses from the majority of regulatory authorities showed that a Decision adopted based on this interpretation could not receive the required favourable opinion of the ACER’s Board of Regulators. Thus, only a Decision where all cross-border relevant network elements are eligible for cost sharing was able to gather the required favourable opinion of the ACER’s Board of Regulators.”

14.3 Title 3: Cost sharing principles.

1227. Appellant VI³⁵¹ extends its claim that ACER exceeded its competence to implement a delegated measure, namely an implementing act (CACM), as defined in Article 291 TFEU, by supplementing the principles of cost allocation provided for in the CACM instead of ensuring its uniform application, to Title 3, Cost Sharing Principles (not only to the common threshold for acceptable LFs).
1228. The Defence³⁵² responds that ACER was competent to adopt the Contested Decision under Articles 5(3) and 6(10) ACER Regulation. It also replies that (i) ACER was competent to set a common threshold and did not breach the principle of conferral.
1229. Appellant VI only develops its arguments regarding the common threshold for acceptable LFs and not for the rest of Title III, i.e. mapping of XRA costs to XNECs (Article 5), flow decomposition on XNECs (Article 6) and the remaining issues of the distribution of costs on XNECs to TSOs (Article 7).
1230. The Board of Appeal consequently refers to Sub-plea 14.2 on the common threshold for acceptable LFs.

14.4 Priority of loop flows above the threshold.

1231. Appellant IV³⁵³ claims that ACER infringed the principle of conferral of Article 5(1) and (2) TEU when stacking the different flow components in order to determine which flow components contribute to congestion because ACER lacks a legal basis to do so. It claims that ACER has no competence to determine that LFs shall be treated with priority. Appellant IV also claims that, by giving priority to LFs above the threshold, ACER infringes the principle of conferral under Articles 5(1) and (2) TEU. In its view, ACER lacks a legal basis and the competence to determine that internal NEs, especially NEs that are not significantly impacted by electricity trades between 2 BZs shall be subject to cost sharing under Article 74 CACM. It refers in this context to Article 1(c) and (d) ER and to Article 74(4)(b) CACM, which, in its view, evidence that costs incurred from using RDCT to guarantee firmness of IFs fall outside of the scope of Article 74 CACM.
1232. The Defence³⁵⁴ responds that ACER was competent to adopt the Contested Decision under Articles 5(3) and 6(10) ACER Regulation. It also replies that ACER was competent to prioritise LFs above the threshold and did not breach the principle of conferral.

³⁵¹ Appeal VI, Plea 1, paras 124 and Plea 2, paras 125-151.

³⁵² Defence, paras 188-202, 437-456.

³⁵³ Appeal IV, Plea 4, paras 181-186.

³⁵⁴ Defence, paras 188-202, 611-616.

1233. Articles 5(1) and (2) TEU are quoted above in Sub-plea 14.1.
1234. Article 1(c) ER states that the ER aims to “*set fair rules for cross-border exchanges in electricity, thus enhancing competition within the internal market for electricity, taking into account the particular characteristics of national and regional markets, including the establishment of a compensation mechanism for cross-border flows of electricity, the setting of harmonised principles on cross-border transmission charges and the allocation of available capacities of interconnections between national transmission systems*”.
1235. Article 1(d) ER states that the ER aims to “*facilitate the emergence of a well-functioning and transparent wholesale market, contributing to a high level of security of electricity supply, and provide for mechanisms to harmonise the rules for cross-border exchanges in electricity.*”
1236. Article 74(4)(b) CACM states that the RDCTCS shall at least “*define which costs incurred from using redispatching or countertrading to guarantee the firmness of cross-zonal capacity are eligible for sharing between all the TSOs of a capacity calculation region in accordance with the capacity calculation methodology set out in Articles 20 and 21*”.
1237. As set out above in the Sixth Consolidated Plea, ACER included prioritisation of LFs above the threshold when carrying out its duty of regulatory approval of All Core TSOs’ RDCTCS Proposal as per Article 6(10) of the ACER Regulation.
1238. ACER took the Contested Decision on the basis of Article 6(10) of the ACER Regulation. That is the legal basis of the Contested Decision, including the RDCTCS in its Annex 1 and including, therefore, the Distribution of costs on XNECs to TSOs (Article 7 of the Contested Decision’s RDCTCS).
1239. ACER did not exceed its competence. ACER’s competence has to be situated in a bottom-up decision-making process foreseen by the EU energy regulation. In this bottom-up decision-making process, the role of the regulators – either the NRAs or ACER – is to assess whether TSO proposals comply with the applicable regulatory framework in order to subsequently grant regulatory approval.
1240. Indeed, the bottom-up decision-making process provides that the initiative comes from the market (TSOs) but is supervised by regulatory authorities (NRAs or ACER) to ensure adequate regulatory compliance by private companies having private interests, in particular on CB issues. In the present case, All Core NRAs referred decision-making on All Core TSOs’ RDCTCS Proposal to ACER on the basis of Article 9(11) CACM: “*Where the regulatory authorities have not been able to reach agreement within the period referred to in paragraph 10, or upon their joint request, the Agency shall adopt a decision concerning the submitted proposals for terms and conditions or methodologies within six months, in accordance with Article 8(1) of Regulation (EC) No 713/2009.*”
1241. ACER did not exceed its powers. ACER carried out the regulatory supervision of All Core TSOs’ RDCTCS Proposal under the CACM which had been referred to it by All NRAs in accordance with the CACM’s referral procedure. In carrying out its functions of regulatory supervision, ACER had to take account of the fact that All Core TSOs’ RDCTCS Proposal recognised the principle of a priority stack without, however, determining a precise stack, whilst taking due account of the views of All Core NRAs. ACER therefore included a priority stack in the Contested Decision’s RDCTCS in accordance with the applicable regulatory requirements. ACER did not bestow additional powers on itself beyond the powers conferred by the ACER Regulation. It exercised the powers that it was under an obligation to exercise in accordance with Article 9(11) of the CACM and Article 6(10) of the ACER Regulation.
1242. As set out in the Sixth Consolidated Plea, a priority stack that prioritises LFs above the threshold as the primary contributors to the congestion is necessary to attain the objectives set by the CACM and the ER. As set out in Sub-Pleas 6.6 and 6.8, it creates the correct incentives to manage congestion and fosters an efficient development and operation of the EU interconnected system and electricity market in the long term (Article 74(6)(a) and (e) CACM). As set out in Sub-Plea 6.9, is consistent with the responsibilities and liabilities of Core TSOs (Article 74(6)(b) CACM). As set out in Sub-Plea 6.10, it ensures a fair distribution of costs and benefits between Core TSOs (Article 74(6)(c) CACM). As set out in Sub-Plea 6.13, it facilitates adherence to the general principles of CM (Article 74(6)(f) CACM). As set out in the Eleventh Consolidated Plea, it complies with the principle of

proportionality. Finally, as set out in the Twelfth Consolidated Plea, it complies with the principles of transparency and non-discrimination (Article 74(6)(i) CACM).

1243. As set out in the Sixth Consolidated Plea, placing IFs as no.1 in the priority list, alongside LFs above the threshold, would not have been in accordance with the PPP, contained in both Article 16(13) ER and Article 76(1) SO because it decreases LFs above the threshold and treats unequal flows equal, in violation of the principle of non-discrimination. It would, moreover, not have created the correct incentives to manage congestion and would not have fostered the efficient development and operation of the EU interconnected system and electricity market in the long term. It would also not have been consistent with the responsibilities and liabilities of Core TSOs. Finally, it would not have ensured a fair distribution of costs and benefits between Core TSOs.

14.5 Review of RDCTCS.

1244. Appellant IV³⁵⁵ claims that ACER infringed the principle of conferral of Article 5(1) and (2) TEU when imposing an obligation on Core TSOs to propose an amendment to the adopted RDCTCS in Article 12(2) of the Contested Decision's RDCTCS because ACER lacks a legal basis and the competence to decide whether Core TSOs shall amend the RDCTCS. In its view, under Article 9(13) CACM, the only authorities competent in this regard are Core NRAs.

1245. The Defence³⁵⁶ responds that (i) the requirement imposed on Core TSOs to submit proposals for amendment to the RDCTCS does not alter Core NRAs' competences to require Core TSOs to submit proposals for amendments under Article 9(13) CACM and (ii) ACER did not breach the principle of conferral because it was entitled to require TSOs to table amendments in order to ensure compliance with Article 74 CACM.

1246. Articles 5(1) and (2) TEU are quoted above in Sub-plea 14.1.

1247. Article 9(13) CACM states that *"TSOs or NEMOs responsible for developing a proposal for terms and conditions or methodologies or regulatory authorities responsible for their adoption in accordance with paragraphs 6, 7 and 8, may request amendments of these terms and conditions or methodologies. The proposals for amendment to the terms and conditions or methodologies shall be submitted to consultation in accordance with the procedure set out in Article 12 and approved in accordance with the procedure set out in this Article."*

1248. Article 12(2) of the Contested Decision's RDCTCS reads as follows: *"No later than twelve months after the implementation of this cost sharing methodology, all Core TSOs shall develop a proposal for amendment of this methodology, which shall aim to improve all the aspects of this cost sharing methodology. By the same deadline, the proposal for amendment shall be submitted for approval to Core regulatory authorities."*

1249. ACER took the Contested Decision on the basis of Article 6(10) of the ACER Regulation. That is the legal basis of the Contested Decision, including the RDCTCS in its Annex 1 and including, therefore, the obligation for Core TSOs to amend the RDCTCS within 12 months of its adoption (Article 13 of the Contested Decision's RDCTCS).

1250. ACER did not exceed its competence. ACER's competence has to be situated in a bottom-up decision-making process foreseen by the EU energy regulation. In this bottom-up decision-making process, the role of the regulators – either the NRAs or ACER – is to assess whether TSO proposals comply with the applicable regulatory framework in order to subsequently grant regulatory approval.

1251. Indeed, the bottom-up decision-making process provides that the initiative comes from the market (TSOs) but is supervised by regulatory authorities (NRAs or ACER) to ensure adequate regulatory compliance by private companies having private interests, in particular on CB issues. In the present case, All Core NRAs referred decision-making on All Core TSOs' RDCTCS Proposal to ACER on the basis of Article 9(11) CACM: *"Where the regulatory authorities have not been able to reach agreement within the period referred to in paragraph 10, or upon their*

³⁵⁵ Appeal IV, Plea 6, paras 194-195.

³⁵⁶ Defence, paras 781-796.

joint request, the Agency shall adopt a decision concerning the submitted proposals for terms and conditions or methodologies within six months, in accordance with Article 8(1) of Regulation (EC) No 713/2009.”

1252. The powers conferred upon ACER by EU law are to supervise All Core TSOs’ initiative to ensure compliance with the EU regulatory framework. In its role as regulator, when exercising regulatory oversight over All Core TSO’s RDCTCS Proposal, ACER had to ensure compliance with the applicable regulatory framework.
1253. ACER did not exceed its powers. ACER carried out the regulatory supervision of All Core TSOs’ RDCTCS Proposal under the CACM which had been referred to it by All NRAs in accordance with the CACM’s referral procedure. In so doing, ACER reproduced All TSOs’ RDCTCS Proposal and merely linked the obligation upon Core TSOs to amend the RDCTCS of Article 14 of All Core TSO’s RDCTCS Proposal to the annual review procedure of Article 13 of All Core TSO’s RDCTCS Proposal. ACER did not bestow additional powers on itself beyond the powers conferred by the ACER Regulation. It exercised the powers that it was under an obligation to exercise in accordance with Article 9(11) of the CACM and Article 6(10) of the ACER Regulation.
1254. Article 13 of All Core TSOs’ RDCTCS Proposal contained an annual review process of the RDCTCS in order to identify possible improvements regarding the effectiveness of applied RAs and the appropriateness, fairness and effectiveness of cost sharing. Article 14 of All Core TSOs’ Proposal contained (i) an obligation to publish the RDCTCS; (ii) an obligation to amend the RDCTCS during the year following its approval or as soon as the details requiring clarification are available (*“This Cost Sharing Methodology shall be amended by Core TSOs no later than 12 months after its approval, or as soon as the details that require clarification are available, whichever happens earlier”*) and (iii) a statement that the RDCTCS’ implementation is conditional upon regulatory approval of the RDCTCS (Article 9 CACM), of the RDCT (Article 35(1) CACM), of the CCM (Articles 20 and 21 CACM), of the CSAM (Article 75(1) SO), of the ROSC (Article 76(1) SO) and of the development, testing and implementation of IT tools, systems and procedures required to support the RDCTCS:
- “Article 14 Implementation*
- 1. Core TSOs shall publish this Cost Sharing Methodology without undue delay after its approval in accordance with article 9(10), articles 9(11) or 9(12) of the CACM guideline.*
 - 2. This Cost Sharing Methodology shall be amended by Core TSOs no later than 12 months after its approval, or as soon as the details that require clarification are available, whichever happens earlier. This amendment shall also contain a detailed time plan for implementation in accordance with Article 9(13) of the CACM guideline.*
 - 3. The implementation of the Cost Sharing Methodology is subject to: a. Regulatory approval of this Cost Sharing Methodology in accordance with Article 9 of CACM guideline; b. Regulatory approval of the Core RD and CT Methodology pursuant to Article 35(1) of CACM guideline in accordance with Article 9 of CACM guideline; c. Regulatory approval of common coordinated capacity calculation methodology required by Articles 20 and 21 of CACM guideline in accordance with Article 9 of CACM guideline; d. Regulatory approval of the coordinated security analysis methodology pursuant to Article 75(1) of SO guideline, its implementation, the regulatory approval of the methodology for regional operational security coordination pursuant to Article 76(1) of SO guideline and its implementation; e. Development, testing and implementation of the IT tools, systems and procedures required to support the Cost Sharing Methodology”*
1255. The Explanatory Document to All Core TSOs’ RDCTCS Proposal³⁵⁷ states in the same line: *“In article 14 of the submitted methodology, Core TSOs commit themselves to submit an amended version of this methodology, no later than 12 months after its approval or after an agreement is reached on the details of the cost sharing application (whichever happens earlier).”*
1256. That is precisely why ACER introduced an obligation upon All Core TSOs to amend the RDCTCS no later than 12 months after its approval.
1257. Furthermore, in order to ensure compliance of All Core TSO’s RDCTCS Proposal with the applicable legal framework, ACER linked the obligation to table an amendment to the annual review of the RDCTCS, as set out below in the Nineteenth Consolidated Plea. This is confirmed by paragraph 154 of the Contested Decision: *“The review should be followed by the*

³⁵⁷ Annex 13 to the Defence, p. 55.

development of a proposal for an amendment of the cost sharing methodology submitted to Core regulatory authorities for approval.”

1258. ACER did not adopt the Contested Decision on the basis of Article 9(13) CACM. The Contested Decision creates the RDCTCS. Article 9(13) CACM does not cover the creation of the RDCTCS but a regulatory possibility for All TSOs to amend the RDCTCS within 12 months of its adoption. ACER’s powers to adopt the RDCTCS have to be distinguished from later amendments down the line in accordance with Article 9(13) CACM. For Article 9(13) CACM to apply, allowing for amendments to the RDCTCS, the RDCTCS needs to be created in the first place. The Contested Decision creates the RDCTCS.
1259. The Contested Decision represents “*these terms and conditions or methodologies*” referred to in Article 9(13) CACM, used as a starting point for any subsequent amendment in accordance with Article 9(13) CACM. This means that, after the Contested Decision providing the regulatory approval to the RDCTCS, All TSOs are allowed to table RDCTCS amendments. Yet by virtue of the Contested Decision, All TSOs are requested to table an amendment to improve the RDCTCS within 12 months. Article 9(3) CACM will apply to this amendment. This implies that TSOs will need to hold a new consultation on the proposed amendments in accordance with Article 12 CACM.
1260. When ACER mandates All TSOs to develop a proposal for amendment of the RDCTCS, ACER exercises its competence under Article 6(10)(a) of the ACER Regulation read in conjunction with Article 5(3) ACER Regulation and Article 9(11) CACM (the referral by All Core NRAs to ACER). It does not by any means usurp All Core TSOs’ competence to take initiatives to develop proposals under Article 9(13) CACM and to hold consultations under Article 12 CACM.
1261. The Board of Appeal refers to its earlier decision-making Decision A-008-2020³⁵⁸, in which it held that, when ACER Decision 13/2020 on the Implementation framework for a European platform for the imbalance netting process (“**INIF**”) mandated All TSOs to develop a proposal for amendment of the INIF in order to designate a Capacity Management Function- entity, ACER created the INIF and, hence, amendment provisions did not apply. ACER did not act on the basis of the amendment provision of Article 6(3) of Commission Regulation (EU) 2017/2195 establishing a guideline on electricity balancing (“**EBGL**”) because ACER could not amend something that had not been created in the first place. ACER exercised its competence under Article 6(10)(b) of the ACER Regulation read in conjunction with Article 5(7) of the EBGL to create the INIF, containing an obligation upon TSOs to table an amendment in future to designate a Capacity Management Function-entity. This obligation for TSOs to table an amendment *per se* was part of the INIF, taken on the basis of Article 6(10)(b) of the ACER Regulation and not taken on the basis of the amendment provision of Article 6(3) EBGL. Article 6(3) EBGL did not apply to the creation of the INIF. The INIF contained an obligation for TSOs to amend the INIF in future. This means that, when the TSOs, in future, will implement that obligation and develop the amendments, these amendments will follow the amendment procedure set out in Article 6(3) of the EBGL. In other terms, introducing an obligation to amend was not covered by the amendment provision but the implementation of the amendment provisions will be covered by the amendment provision.
1262. The obligation of Article 12(2) of the Contested Decision’s RDCTCS does not in any way restrict or otherwise affect All Core TSOs’ competence to submit proposals for amendments to the RDCTCS in accordance with Article 9(13) CACM. Finally, the Board of Appeal notes that Article 9(13) CACM’s amendment procedure refers to the ordinary bottom-up decision-making process of EU energy regulation. This implies

358

https://acer.europa.eu/en/The_agency/Organisation/Board_of_Appeal/Decisions/A-008-2020%20Decision%20Board%20of%20Appeal.pdf

that, when it refers to “regulatory authorities”, it means NRAs or, if they have not been able to reach an agreement within a certain deadline or upon their joint request, ACER.

14.6 Netting of flow components.

1263. Appellant IV³⁵⁹ claims that ACER acted without a legal basis when it chose not to address the questions of “if” and “how” netting should be performed.
1264. In its Defence³⁶⁰, ACER responds that the Contested Decision’s RDCTCS does not include the netting for the allocation of different types of flows to the overload because there is no legal obligation to do so and that it ensured compliance the general CM principles of Article 16 ER, in particular Article 16(13) ER and the PPP.
1265. ACER adopted the Contested Decision on the basis of Article 6(10)(a) ACER Regulation. That is the legal basis of the Contested Decision, including the RDCTCS in its Annex 1 and, more specifically, Article 7 on the Distribution of costs on XNECs to TSOs, where no additional netting process is foreseen for the allocation of flow types to the overload. The Contested Decision is not silent on the legal basis: Section 3 of the Contested Decision entitled “*ACER’s competence to decide on the Proposal*”, in paragraphs 12 to 18 of the Contested Decision, sets out the legal basis for the Contested Decision.
1266. As set out throughout this decision, ACER’s competence needs to be placed in the RDCTCS’ bottom-up decision-making process. In this process, ACER carried out the regulatory supervision of All Core TSOs’ RDCTCS Proposal under Article 74 CACM, which stipulates in Article 74(6)(f) that the RDCTCS needs to facilitate adherence to the general principles of CM as set out in Article 16 ER.
1267. As set out above in the Fifth Consolidated Plea and in paragraphs (58) and 62(d) of the Contested Decision, Article 8(4) of All Core TSOs’ RDCTCS Proposal contained a netting process of relieving and burdening flows as a first step in the transformation of decomposed flow components into shares (%) for each BZ, but did not specify why and how this netting had to be performed. Neither All Core TSOs’ RDCTCS Explanatory Document, nor their Experimentation Report nor their Non-Paper clarified the proposed netting process, which was discussed between ACER All Core NRAs and All Core TSOs during the consultation and hearing phase. All Core NRAs’ Non-Paper did not address the issue of netting.
1268. As set out in detail in the Fifth Consolidated Plea, in order to ensure compliance with Article 74 CACM and to facilitate adherence to the general principles of CM of Article 16 ER, Article 7(6) of the Contested Decision’s RDCTCS contains an implicit netting process with respect to the calculation of the overload per NE (calculation of total flow on each NE facing congestion) but does not contain an additional netting process for the allocation of flow types to the overload.
1269. **It follows that the Fourteenth Consolidated Plea must be dismissed as unfounded.**

Fifteenth Consolidated Plea – ACER exercised NRAs’ competences.

1270. Appellant II³⁶¹ claims that ACER exceeded its competence when establishing the scope of the RDCTCS because network operation and investment decisions are competences that have been left to the supervision of NRAs by the division of competences between the EU and the Member States, initiated with the First Energy Package. It states that NRAs are in charge of approving non-discriminatory and efficient rules for the operation of and investment in their national network infrastructure, with the aim to ensure that end consumers benefit from adequate and cost-effective network fees or tariffs. It claims, therefore, that the expansion of the RDCTCS scope to a set of NEs that is larger than CNECs goes beyond the competence of ACER.

³⁵⁹ Appeal IV, Plea 2, para 76.

³⁶⁰ Defence, paras 416-430.

³⁶¹ Appeal II, Plea 6, para 148.

1271. In Appellant IV's view³⁶², Article 16(13) ER expressly states that the competence to approve All Core TSOs' proposal for a legitimate LF threshold is a competence of All Core NRAs. ACER lacks, in its view, the competence to determine any LF threshold.
1272. Appellant VI³⁶³ claims that the ER confers the competence to calculate and apply the threshold on Core TSOs subject to regulatory approval by Core NRAs and that ACER cannot appropriate that competence for itself.
1273. In its Defence³⁶⁴, ACER responds that (i) its competence to adopt binding decisions derives directly and immediately from EU Law, and specifically from Article 6(10) ACER Regulation and (ii) it is not exercising a delegated or derived competence from NRAs but an exclusive competence which is its own, granted to it by the EU legislator via the ACER Regulation, when the respective requisites are met.
1274. As set out above in the Fourteenth Consolidated Plea, ACER was under a regulatory obligation to adopt the Contested Decision following All Core NRA's referral. In a letter of 27 March 2020, the Chair of the Core Energy Regulators' Regional Forum informed ACER on behalf of All Core NRAs that they had not been able to reach a decision on All Core TSOs' RDCTCS Proposal by the extended deadline of 27 March 2020. They consequently referred the decision-making on All Core TSO's RDCTCS Proposal to ACER.
1275. The CACM is an implementing act on the basis of the Old ER (part of the EU's Third Energy Package) mandating All Core TSOs to develop a RDCTCS proposal for regulatory supervision by the regulatory authorities (All Core NRAs or, upon referral as provided by Article 9(11) CACM ACER).
1276. Following All Core NRAs' referral under Article 9(11) CACM, ACER was under a regulatory obligation to adopt the RDCTCS decision in accordance with Article 6(10) ACER Regulation. ACER duly complied with its obligations as mandated by EU legislation.
1277. Appellant II's claim amounts to a challenge of the division of energy competences by the EU legislator and not to a challenge of ACER's decision-making power in accordance with EU legislation.
1278. Regarding the statement of Appellant II in its Reply, according to which ACER "*cannot supersede NRA competences*"³⁶⁵, the Board of Appeal notes that ACER does not supersede NRA competences when it adopts an individual decision under the ACER Regulation following All Core NRAs' referral, but complies with its regulatory duties.
1279. **It follows that the Fifteenth Consolidated Plea must be dismissed as unfounded.**

Sixteenth Consolidated Plea – Language plea.

1280. Appellant II³⁶⁶ and Appellant VI³⁶⁷ claim that, when adopting the Contested Decision, ACER infringed the provisions on the use of languages in the EU, by not issuing the Contested Decision in the official language of these Appellants' Member State, i.e. French, but solely in English.
1281. Appellant II claims that the absence of a French translation of the Contested Decision infringes Articles 3 and 4 of Regulation No.1 (EEC) 1/1958 determining the languages to be used by the European Economic Community ("**Council Regulation No.1**"), Article 44 ACER Regulation, Article 3(3) TEU and Article 22 Charter. It also claims an infringement of the principle of legal certainty, of its right of defence and of the Board of Appeal's Rules of Procedure.

³⁶² Appeal IV, Plea 3, para 116.

³⁶³ Appeal VI, Plea 2, para 148.

³⁶⁴ Defence, paras 188-196 and 447.

³⁶⁵ Reply of Appellant II, para 19.

³⁶⁶ Appeal II, Plea 1, paras 57-73.

³⁶⁷ Appeal VI, Plea 9, paras 317-337.

1282. Appellant VI argues that the absence of a French translation of the Contested Decision infringes Articles 3 and 4 of Regulation No.1, Article 44 ACER Regulation, Article 3(3) TEU and Article 22 Charter. Appellant VI also invokes an infringement of the principle of legal certainty and of its rights of defence. Appellant VI requests the Contested Decision's annulment or, in the alternative, its unenforceability against Appellant VI pending the receipt of a French language version and requests that the implementation deadline of Article 13 of the Contested Decision's RDCTCS be accordingly extended.
1283. The Defence³⁶⁸ argues that (i) the Contested Decision is not a measure of general application within the meaning of Article 4 of Regulation No.1 and does not violate Article 3 of Regulation No.1 and that (ii) the use of English in the Contested Decision pursues a legitimate objective, complies with the principles of proportionality and legal certainty and does not breach the Appellants' rights of defence.

16.1 Article 4 of Council Regulation No.1.

1284. The Contested Decision was exclusively drafted and published in English.

1285. Article 2 of the Contested Decision stipulates that it is addressed to:

- 1 50Hertz Transmission GmbH,
- 2 Amprion GmbH,
- 3 Austrian Power Grid AG,
- 4 C.N.T.E.E. Transelectrica S.A.,
- 5 ČEPS a.s.,
- 6 Creos Luxembourg S.A.,
- 7 ELES, d.o.o.,
- 8 Elia System Operator NV/SA³⁶⁹,
- 9 HOPS d.o.o., Hrvatski operator prijenosnog sustava,
- 10 MAVIR ZRt,
- 11 Polskie Sieci Elektroenergetyczne,
- 12 Réseau de Transport d'Electricité,
- 13 Slovenská elektrizačná prenosová sústava, a.s.,
- 14 TenneT TSO B.V.,
- 15 TenneT TSO GmbH,
- 16 TransnetBW GmbH, and
- 17 VÜEN-Vorarlberger Übertragungsnetz GmbH.

1286. The addressees of the Contested Decision are the TSOs of the Core CCR.

1287. Appellant VI is one of the addressees of the Contested Decision.

1288. Appellant II is a NRA within the meaning of Article 57 of the Electricity Directive within the Core CCR, namely the French NRA.

1289. Both Appellants II and VI have been involved as stakeholders in the bottom-up proceeding leading-up to the Contested Decision.

1290. All addressees, including Appellant VI, received an English language version of the Contested Decision upon its adoption and submitted language waivers, whereby they waived their right to receive the Contested Decision in their national language(s).

1291. Appellant VI submitted a conditional and temporary language waiver to ACER on 8 June 2020. In so doing, Appellant VI conditionally and temporarily waived its right to receive the Contested Decision in French and authorised ACER to address it firstly in English, upon

³⁶⁸ Defence, paras 688-744.

³⁶⁹ The Board of Appeal notes a clerical error, whereby the Belgian TSO, Elia System Operator NV/SA, is cited twice in Article 2 of the Contested Decision.

condition that it would receive a French language version of the Contested Decision within 15 days of its publication in English³⁷⁰.

1292. All Core NRAs, including Appellant II, received a copy of the Contested Decision in English upon its adoption on 30 November 2020³⁷¹.
1293. Appellant VI received a French language version of the Contested Decision on 11 February 2021³⁷².
1294. Article 44 ACER Regulation states that “*the provisions of Council Regulation No.1 shall apply to ACER*”, clarifying in footnote 30 that this concerns Council Regulation No 1 determining the languages to be used by the European Economic Community.
1295. The application of Council Regulation No.1 to ACER has been confirmed by the Board of Appeal in its earlier decision-making practice³⁷³.
1296. Article 4 of Council Regulation No.1 requires the drafting and publication in all official languages of “*regulations and other documents of general application*”. In accordance with that provision, the availability of documents in all official languages is only justified for documents of general and abstract effects felt throughout the EU.
1297. The Contested Decision is, however, not a document of general application. As evidenced above, the Contested Decision is an individual decision addressed to 17 TSOs of the Core CCR, adopted by ACER in accordance with Article 6(10) ACER Regulation. Article 6(10) ACER Regulation stipulates that “*ACER shall be competent to adopt **individual** decisions on regulatory issues having effects on cross-border trade or cross-border system security which require a joint decision by at least two regulatory authorities (...)*” (emphasis added). It is included in ACER’s dedicated section of “*Individual Decisions*” on ACER’s website³⁷⁴.
1298. According to the ACER Regulation, ACER does not have the competence to adopt measures of general application. Indeed, Article 2 ACER Regulation, entitled “*Types of acts of ACER*” lists all acts that ACER has the competence to take. It does not contain measures of general application:
“*ACER shall:*
(a) *issue opinions and recommendations addressed to transmission system operators, the ENTSO for Electricity, the ENTSO for Gas, the EU DSO Entity, regional coordination centres and nominated electricity market operators;*
(b) *issue opinions and recommendations addressed to regulatory authorities;*
(c) *issue opinions and recommendations addressed to the European Parliament, the Council, or the Commission;*
(d) *issue individual decisions on the provision of information in accordance with Article 3(2), point (b) of Article 7(2) and point (c) of Article 8; on approving the methodologies, terms and conditions in accordance with Article 4(4), Article 5(2), (3) and (4); on bidding zones reviews as referred to in Article 5(7); on technical issues as referred to in Article 6(1); on arbitration between regulators in accordance with Article 6(10); related to regional coordination centres as referred to in point (a) of Article 7(2); on approving and amending methodologies and calculations and technical specifications as referred to in Article 9(1); on approving and amending methodologies as referred to in Article 9(3); on exemptions as referred to in Article 10; on infrastructure as referred to in point (d) of Article 11; and on matters related to wholesale market integrity and transparency pursuant to Article 12; and*
(e) *submit non-binding framework guidelines to the Commission in accordance with Article 59 of Regulation (EU) 2019/943 of the European Parliament and of the Council and Article 6 of Regulation (EC) No 715/2009 of the European Parliament and of the Council.*”
1299. Furthermore, it is settled case-law that “*a measure is of general application if it applies to objectively determined situations and produces legal effects with respect to categories of persons envisaged generally and in*

³⁷⁰ Annex A.5.1 to Appeal VI; Annex 2 to Appeal II.

³⁷¹ Response by ACER to the Board of Appeal’s First Request for Information.

³⁷² Annex 96 to the Rejoinder.

³⁷³ Board of Appeal Decision A-003-2019, para 177.

³⁷⁴ See https://acer.europa.eu/Official_documents/Acts_of_the_Agency/Pages/Individual-decision.aspx.

*the abstract*³⁷⁵. As set out above, the Contested Decision does not apply to objectively determined situations and does not produce legal effects with respect to categories of persons envisaged generally and in the abstract. The Contested Decision applies to identifiable and exhaustively listed addressees: 17 TSOs of the Core CCR. The Contested Decision only directly concerns these 17 Core TSOs. It defines and imposes specific rights and obligations on these 17 Core TSOs when they share costs under the RDCTCS. The Contested Decision does not directly concern any other market participants. This is expressly set out in Recital (10)(d) of the Contested Decision's RDCTCS: "(...) *On the other hand, this methodology is deemed to have no direct effect on NEMOs, regulatory authorities, ACER and market participants*".

1300. The Board of Appeal refers, by analogy, to its earlier decision-making practice in Case A-003-2019, in which it confirmed that ACER decision 02/2019 was an individual decision and not a document of general application: "(...) *it seems manifest, (...), that it cannot be held that the Contested Decision individually concerns market participants beyond those to whom it is addressed, much less that it individually concerns all market participants. It follows that Article 4 of Regulation No. 1 is not applicable to the Contested Decision.*"³⁷⁶
1301. Appellant II states correctly, in this respect, that the Contested Decision imposes obligations on TSOs and that NRAs have an obligation to supervise those TSOs' obligations to enforce the Contested Decision. This does, however, not alter the individual nature of the Contested Decision.
1302. The fact that the Contested Decision's addressees are 17 legal persons in 13 EU Member States, representing a substantial part of the EU, or that the Contested Decision indirectly affects a large number of persons, namely because tariffs will ultimately be borne by consumers, does not render the Contested Decision a measure of general application, applying to categories of persons envisaged generally and in the abstract. Reasoning otherwise would consider all regulatory decisions to be measures of general application, as they necessarily have an indirect impact on the actual and potential end-customer. According to settled case-law of the CJEU, various circumstances can bring about a closed class of individually identifiable persons and it does not matter whether the class is large or small or whether the members are known by name, they are individual decisions and not measures of general application³⁷⁷.
1303. Appellant VI challenges the Contested Decision's individual nature on the basis of the existence of ACER Decision 31/2020 establishing a RDCTCS for SEE CCR and hypothetical other CCR RDCTCS decisions that ACER would have been required to issue if the NRAs had failed to reach an agreement on All TSOs' Proposals.
1304. The existence of various cost sharing methodology decisions being adopted in parallel for each of the CCRs, exclusively addressed to the TSOs of those CCRs, highlights, on the contrary, the differences in regional coordination due to the characteristics of each CCR and the individual nature of said decisions, which cannot be bundled into a single decision. All of these individual decisions follow different bottom-up decision-making processes with their own, different stakeholders, and are adopted upon approval by the NRAs of the CCR concerned or by ACER, depending on the CCR concerned.
1305. Appellant VI invokes Case C-161/06 *Skoma-Lux*³⁷⁸. However, as the Board of Appeal has already set out in its earlier decision-making practice³⁷⁹, this case merely affirms that general

³⁷⁵ Case T-640/14 *Carsten René Beul v EP and Council* EU:T:2015:907, para 32, quoted in Board of Appeal Decision A-003-2019, para 179. Reaffirmed in Cases C-622/16 P to C-624/16 P *Montessori* EU:C:2018:873, para 29 (quoted by Appellant VI); and in Case T-162/19 *Telefónica* EU:T:2020:7, para 36.

³⁷⁶ Board of Appeal Decision A-003-2019, paras 181-183.

³⁷⁷ See, by analogy, opinion of Advocate General Roemer, *Zuckerfabrik/Council*, 6/68, EU:C:1968:34, p. 419; and opinion of Advocate General Reischl, *Koninklijke Scholten Honig/Council and Commission*, 101/76, EU:C:1977:53, p. 811-812; Judgment of the Court of Justice of 21 May 1987, *Deutsche Lebensmittelwerke/Commission*, C-97/85, EU:C:1987:243, para 11.

³⁷⁸ Case C-161/06, *Skoma Lux*, ECLI:EU:C:2007:773.

³⁷⁹ Board of Appeal Decision A-003-2019, para 188.

rules of EU legislation cannot be enforced in a new Member State as long as that EU legislation has not been published in the official language of that Member State.

16.2 Article 3 of Council Regulation No.1.

1306. Article 3 of Council Regulation No.1 applies to the Contested Decision.
1307. Article 3 of Council Regulation No.1 states that “documents which an institution of the Community sends to a Member State or to a person subject to the jurisdiction of a Member State shall be drafted in the language of such State”.
1308. This provision mirrors Article 22 Charter and Article 3(3) TEU, according to which the EU shall respect linguistic diversity.
1309. Article 22 Charter states: “The Union shall respect cultural, religious and linguistic diversity”.
1310. In line with the Board of Appeal’s consistent decision-making practice, ACER is bound by the general principles of EU Law³⁸⁰.
1311. The Charter’s procedural rights are not absolute rights. Their purpose is not to create abstract procedural obstacles, but to protect the rights of the addressees and other persons concerned by a decision, as provided for by the regulations applicable to such decision and by relevant case law³⁸¹.
1312. Article 3(3) TEU states that the EU “shall respect its rich cultural and linguistic diversity, and shall ensure that Europe’s cultural heritage is safeguarded and enhanced.”
1313. It is settled case-law that Article 3(3) TEU cannot be considered as a general principle of EU law: “references in the Treaties to the use of languages within the European Union cannot be regarded as evidencing a general principle of EU law to the effect that anything that might affect the interests of a European Union citizen should be drawn up in his language in all circumstances”³⁸².
1314. Similarly, the rule found in Article 3 of Council Regulation No.1 is not an absolute right, nor an end in itself, as the Board of Appeal has held in its earlier decision-making practice³⁸³.
1315. Appellant II refers to the Opinion of Advocate-General Bobek in Case C-621/16 P *Commission v Italy*³⁸⁴.
1316. The Board of Appeal observes that no analogy can be drawn with Case C-621/16 P *Commission v Italy*. Case C-621/16 P *Commission v Italy*³⁸⁵ essentially concerns Article 5 of Council Regulation No.1, which requires the notice of an open competition for the recruitment of administrators to be published in all official languages of the EU. Furthermore, in the quotation by Appellant II of Advocate-General Bobek’s Opinion, Advocate-General Bobek confirms that the obligation of multilingualism is not absolute and unfettered.
1317. Appellant VI refers to Case C-147/13 *Spain v Council*.
1318. The Board of Appeal observes that no analogy can be drawn with Case C-147/13 *Spain v Council*. Case C-147/13 *Spain v Council* relates to the possibility to file patent applications with EPO in any EU official language and EPO’s practice of providing access to translations to the extent this is necessary “in order to limit the disadvantages for economic operators who do not have the means of understanding” English documents³⁸⁶. This case confirms that the right of every citizen to have a version of anything that might affect his interests drawn up in his language must observe the principle of proportionality³⁸⁷. In other words, it must be appropriate for attaining the objective pursued and must not go beyond what is necessary to achieve it. It also

³⁸⁰ Board of Appeal Decisions A-001-2017, paras 69 and 114; A-002-2018, para 59; A-001-2019, paras 43, 56, 233-239; A-003-2019, para 149; A-006-2019, paras 41 and 47; A-001-2020, paras 240, 252 and 263; A-002-2020, paras 241, 253 and 264; A-003-2020, para 206 and 235; A-007-2020, paras 66 and 99 and A-008-2020, paras 292-302.

³⁸¹ Board of Appeal Decisions A-001-2017, para 124; A-001-2020, para 253; A-002-2020, para 254; A-007-2020, paras 67 and 101 and A-008-2020, paras 311 and 334.

³⁸² Case C-147/13 *Spain v Council* EU:C:2015:299, para 31.

³⁸³ Board of Appeal Decision A-003-2019, para 184.

³⁸⁴ Case C-261/16 P, *Commission v Italy*, Opinion of Advocate General Bobek, ECLI:EU:C:2018:611.

³⁸⁵ Case C-261/16 P, *Commission v Italy*, ECLI:EU:C:2019:251.

³⁸⁶ Case C-147/13 *Spain v Council* EU:C:2015:299, paras 42-48.

³⁸⁷ Case C-147/13 *Spain v Council* EU:C:2015:299, para 33.

states that even acts of general application can, in certain cases, not be provided in all official languages of the EU if this is justified by a legitimate objective and passes the test of proportionality³⁸⁸. Examples of such legitimate objectives are procedural simplicity, efficiency and cost-effectiveness, ensuring legal certainty and, generally, promoting the objectives of sector specific EU norms³⁸⁹. The CJEU emphasizes that a necessary balance must be maintained between the interests of economic operators and the public interests which may, in certain cases, be in conflict in what concerns the language regime³⁹⁰.

1319. In the present case, the Board of Appeal finds that both Appellants II and VI were capable of fully understanding the contents of the Contested Decision, even if they were not provided with a French language version of the Contested Decision, regardless of the fact that ACER provided a French language version of the Contested Decision to Appellant VI on 11 February 2021³⁹¹.
1320. First, Appellant VI is a regulated entity under Article 2(35) of the Electricity Directive and Appellant II is a NRA under Article 57 of the Electricity Directive. They are, consequently, sufficiently acquainted with the technicalities of RDCTCS, all preparatory documents of which have been drafted in English.
1321. Second, Article 16 of the RDCTCS Proposal of All Core TSOs' contains Article 16, which reads as follows: "*The reference language for this Cost Sharing Methodology shall be English. For the avoidance of doubt, where Core TSOs need to translate this Cost Sharing Methodology into their national language(s), in the event of inconsistencies between the English version published by Core TSOs in accordance with article 9(14) of the CACM guideline and any version in another language, the relevant Core TSOs shall, in accordance with national legislation, provide the relevant national regulatory authorities with an updated translation of the Cost Sharing Methodology.*"(emphasis added). In other words, All Core TSOs, including Appellant VI, submitted a Proposal, which expressly acknowledged that the reference language for the RDCTCS would be English and that All Core TSOs would provide their relevant NRAs (including Appellant II) with an updated translation of the RDCTCS into their national language, where necessary.
1322. Third, the Board of Appeal does not observe that the French language was used by Appellant VI when developing All Core TSOs' RDCTCS Proposal at TSO level. Similarly, the Board of Appeal does not observe that the French language was used by Appellant II during All Core NRAs' regulatory approval stage.
1323. Fourth, the administrative proceedings which led to the adoption of the Contested Decision were conducted entirely in English and Appellants II and VI repeatedly interacted with ACER in English in the scope of those proceedings, without opposing the use of the English language during those proceedings. Appellant II actively participated to all discussions leading-up to the Contested Decision among Core and other NRAs, in ACER's Electricity Working Group and in ACER's BoR, which were conducted in English. Appellant II also issued, jointly with the other Core NRAs, a Non-Paper on All Core TSOs' RDCTCS Proposal in English. Appellant VI issued, jointly with the other Core TSOs, All Core TSOs' RDCTCS Proposal, All Core TSOs' Experimentation Report and All Core TSOs' Non-Paper on the RDCTCS Proposal, in English. It also actively participated to the extensive consultations that ACER held with All Core TSOs and All Core NRAs in English.
1324. Fifth, neither the appeal of Appellant II nor the appeal of Appellant VI identify any specific point of the contents of the Contested Decision which they were incapable of fully understanding as a result of the absence of a French translation.
1325. Finally, as alleged by the Defence, the use of English is justified by procedural economy and simplicity, especially given the fact that ACER was bound by Article 6(12) ACER Regulation and 9(11) CACM to adopt its decision in a 6 month timeframe.

³⁸⁸ Case C-147/13 Spain v Council EU:C:2015:299, para 33.

³⁸⁹ Case C-147/13 Spain v Council EU:C:2015:299, paras 34-35.

³⁹⁰ Case C-147/13 Spain v Council EU:C:2015:299, para 41.

³⁹¹ Annex 96 to the Rejoinder.

1326. While both Appellants refer to the complexity of the decision, such complexity does not alter the outcome of the previous considerations: throughout the proceedings leading-up to the Contested Decision and now in their appeals before the Board of Appeal, both Appellants – regulated entities under the Electricity Directive - have demonstrated an in-depth understanding of the rights and obligations deriving from the Contested Decision. For All Core TSOs’ commodity, ACER also provided a marked-up version of their initial All Core TSOs’ RDCTCS Proposal as Annex 1a to the Contested Decision.
1327. Both Appellants argue that ACER’s practice of seeking language waivers from addressees implicitly recognizes the addressees’ right to receive the Contested Decision in its official language(s). At the Oral Hearing, Appellant VI held that its right to receive the decision in French is unconditional.
1328. As set out in the Board of Appeal’s earlier decision-making practice³⁹², ACER uses language waivers as a preventive measure to increase legal clarity, especially given the high volume of appeals with which ACER has been faced. Yet the fact that ACER uses language waivers to avoid exposure to legal challenges does not by any means imply that it acknowledges that any legal challenge on the use of English when adopting its decisions is well-founded. The Board of Appeal notes that Council Regulation No. 1 does not impede or otherwise restrict the use of language waivers.
1329. Appellant VI claims that ACER has recognized its obligation to translate its individual decisions into Member States’ official languages at the 69th, 71st, 72nd, 73rd, 77th and 84th meetings of the BoR in 2017, 2018 and 2019³⁹³. A reading of the minutes of those meetings does not confirm this statement. The positions expressed by ACER’s Director in these BoR meetings essentially evidence that ACER uses waivers to increase legal certainty and dissuade litigation on language issues and that the practice of language waivers is burdensome. To illustrate this, the Board of Appeal quotes the extracts of the minutes of the 69th meeting of the BoR: “*The Director informed the members that the process to collect language waivers from all TSOs in respect of ACER decisions is very burdensome and often practically impossible given the tight deadlines to prepare such decisions. Moreover, some TSOs seem reluctant to provide the waiver. The cost of translating any decision into several languages is prohibitive for the Agency. Not receiving the waiver from some TSOs exposes the Agency’s decisions to legal proceedings. The Director invited all NRAs to raise TSOs’ awareness about this issue and to help ACER make the process smoother and legally robust. The BoR and the Director discussed pragmatic solutions to address this problem including seeking the waivers early in the process and, where these are not provided, relying on the support of NRAs for translations.*”³⁹⁴
1330. The references to the goal of making the process “*smoother and legally more robust*”³⁹⁵ and to a translation into all official languages of the EU being the “*fully safe*” or “*safest*” solution³⁹⁶ do not recognise a legal obligation to translate ACER’s individual decisions into all official languages of its addressees but reflect an attempt to find a pragmatic solution within the confines of the law, and a debate about how to reduce litigation: “*pragmatic solutions to address this problem*”, “*the most pragmatic option*” (69th BoR meeting); “*the need to come up with a pragmatic approach (possibly based on language waivers)*” and “*a pragmatic approach to address this issue was discussed*” (72nd BoR meeting); “*language waivers represent perhaps the most pragmatic option to address the problem*”, “*the Director trying to seek a pragmatic solution*” (71st BoR meeting); and “*pragmatic approach*” (77th BoR meeting).
1331. In this respect, the Board of Appeal required ACER on 16 April 2021 to disclose certain documents, as suggested by Appellant VI in its appeal, namely (i) the cover note and letter presented to the BoR in connection with the meeting of 13 December 2017, and (ii) the legal

³⁹² Board of Appeal Decision A-003-2019, para 190.

³⁹³ Annex A.4 to Appeal VI.

³⁹⁴ Annex A.4.1 to Appeal VI.

³⁹⁵ 69th BoR meeting, Annex A.4.1 to Appeal VI.

³⁹⁶ 71st BoR meeting, Annex A.4.3 to Appeal VI and 72nd BoR meeting, Annex A.4.2 to Appeal VI..

advice presented by the Legal Expert Network (“LEN”) in connection with the meeting of 14 March 2018. Upon their receipt, the Board of Appeal duly analysed the disclosed documents *in camera* given their confidential nature. The documents do not modify the Board of Appeal’s assessment of the language waivers set out above with respect to ACER’s practice of using language waivers.

1332. In accordance with its earlier decision-making practice³⁹⁷, the Board of Appeal notes, furthermore, that the CJEU has clarified on various occasions that language irregularities do not entail the nullity of decisions. This is because the supply of the document in the language of the Member States is not an end in itself, but a requirement meant to ensure that the addressee is duly informed and able to exercise its rights of defence. It is settled case-law that, as long as the addressee was able in due time to acquaint itself with the contents of the decision and to exercise the right of appeal and defence in an adequate and timely fashion, the decision cannot be deemed to be vitiated by the language in which it was notified to the addressee³⁹⁸.
1333. It is also settled case-law that an undertaking cannot claim that the protection of its rights was impaired by the use of a given language when that undertaking, itself, used that language in the administrative proceedings before the EU body in question³⁹⁹. This implies that the fact that ACER did not provide a French translation to Appellant VI within the deadline of 15 days, set by Appellant VI’s voluntary waiver of a *droit disponible*⁴⁰⁰ cannot be cause for the invalidity of the Contested Decision. With respect to Appellant VI’s request that the Contested Decision should in any event be declared unenforceable against Appellant VI until a French translation has been provided to it, first, Appellant VI was provided with a French translation of the Contested Decision on 11 February 2021; second, Appellant VI was capable of fully understanding the content and implications of the Contested Decision and preparing for its implementation, even if it would not have been provided with a French translation; and third, the application of the implementation timescale provided by the Contested Decision’s RDCTCS to All Core TSOs, set out above in the Tenth Consolidated Plea, is not conditional upon translation issues. Moreover, Article 14 of the Contested Decision’s RDCTCS expressly states that the reference language for the RDCTCS is English: “**The reference language for this methodology shall be English.** For the avoidance of doubt, where Core TSOs need to translate this methodology into their national language(s), in the event of inconsistencies between the English version published by TSOs in accordance with Article 9(14) of the CACM Regulation and any version in another language, the relevant Core TSOs shall, in accordance with national legislation, provide the relevant Core regulatory authorities with an updated translation of the methodology.”(emphasis added).
1334. In any event, with respect to Appellant VI, although Appellant states in its Reply that “RTE has never received a French-language version of the Decision”⁴⁰¹, it was provided a French version of the Contested Decision by ACER on 11 February 2021⁴⁰². As set out by ACER at the Oral Hearing, the reason why this was not done within the deadline of 15 days is that ACER is obliged by Article 44(3) ACER Regulation to request translations to the Translation Centre for the Bodies of the EU in Luxembourg, which has its own agenda and own priority stack. Article 44(3) ACER Regulation states: “The translation services required for ACER’s

³⁹⁷ BoA Decision A-003-2019, para 190.

³⁹⁸ See, e.g.: Case 41/69 ACF Chemiefarma EU:C:1970:71, paras 49-52. Case T-293/11 Holcim EU:T:2014:127, para 35. The same is true even for other irregularities, such as the procedure used for notification of the decision – see, e.g.: Case T-138/07 Schindler Holding EU:T:2011:362, para 61. Case C-261/16 P, Commission v Italy, ECLI:EU:C:2019:251, para 126.

³⁹⁹ Case T-144/07 ThyssenKrupp Liften Ascenseurs EU:T:2011:364, para 86. CRE’s reference Appeal A-002-2021, para 61) to AG Bobek’s Opinion in Case C-621/16 P (para 160) refers to a general affirmation of the basic principle on this matter, in a case which had no point in common and no analogy with the present case, and thus is not helpful to assess the exceptions to the rule discussed herein.

⁴⁰⁰ BoA Decision A-003-2019, para 190.

⁴⁰¹ Reply of Appellant VI, para 72.

⁴⁰² Annex 96 to the Rejoinder.

functioning shall be provided by the Translation Centre for the Bodies of the European Union.” Recital (39) ACER Regulation states: “The Translation Centre for the Bodies of the European Union (the ‘Translation Centre’) should provide translation for the Union Agencies. If ACER experiences particular difficulties with the services of the Translation Centre, ACER should have the possibility of invoking the recourse mechanism established in Council Regulation (EC) No 2965/94, which could, ultimately, result in recourse to other service providers under the auspices of the Translation Centre Council Regulation (EC) No 2965/94 of 28 November 1994 setting up a Translation Centre for bodies of the European Union.”

16.3 Legal certainty.

1335. Appellant II claims that the absence of a possibility to fully understand the obligations imposed by ACER’s Contested Decision on the French TSO under its supervision is contrary to the principle of legal certainty.
1336. Appellant VI also invokes the infringement of the principle of legal certainty, to the extent it requires EU legal acts to be clear and precise so that persons concerned by them may know unambiguously their rights and duties and take measures accordingly. Appellant VI refers, in this respect, to Cases C-66/74 *Farrauto v Bau-Berufsgenossenschaft* and C-340/08 *The Queen*.
1337. The principle of legal certainty requires that the rights conferred to individuals by EU law must be implemented in a way which is sufficiently precise, clear and foreseeable to enable the persons concerned to know precisely their rights and obligations, to take steps accordingly and to rely on those rights”⁴⁰³.
1338. There is no infringement of the principle of legal certainty because both Appellants were able to fully understand the Contested Decision and the rights and obligations set out by the RDCTCS for its addressees.
1339. Case C-66/74 *Farrauto v Bau-Berufsgenossenschaft*, relating to an Italian worker being served a judgment by a German court in German concerning a compensation for a workplace accident, relates to court proceedings against a foreign citizen and identifies concerns with legal certainty when “the decision is notified to the person concerned in a language which he does not understand”⁴⁰⁴. Case C-340/08 *The Queen* only relates to proceedings of a criminal nature and identifies concerns with legal certainty when provisions in domestic law involving criminal penalties for the infringement of domestic criminal law are not sufficiently clear and precise so that persons concerned “may know unambiguously their rights and duties”⁴⁰⁵. The analogies are moot because the serving of ACER’s Decision upon Core TSOs does not in any manner involve judicial proceedings.

In any event, although Appellant VI states in its Reply that “RTE has never received a French-language version of the Decision”⁴⁰⁶, ACER provided Appellant VI with a French language version of the Contested Decision on 11 February 2021⁴⁰⁷.

16.4 Rights of defence.

1340. Appellant II⁴⁰⁸ claims that its rights of defence - including Article 3(3) TEU, Article 22 Charter and Article 19 of the Rules of Procedures of the Board of Appeal - have been infringed by the fact that Appellant II submitted its appeal to the Board of Appeal in English.
1341. Article 19(1) of the Rules of Procedure of the Board of Appeal⁴⁰⁹ determines, for non-addressees of ACER Decisions, that the language of the proceedings is determined by the language in which the notice of appeal is lodged: “The language in which the notice of appeal has been lodged shall be the language of the case on appeal. If the appellant is the addressee of the decision against

⁴⁰³ Case C-171/18, *Safeway Ltd*, ECLI:EU:C:2019:839, para 25.

⁴⁰⁴ Case 66/74 *Farrauto* EU:C:1975:18, para 6.

⁴⁰⁵ Case C-340/08 *The Queen* EU:C:2010:232, paras 64-65.

⁴⁰⁶ Reply of Appellant VI, para 72.

⁴⁰⁷ Annex 96 to the Rejoinder.

⁴⁰⁸ Appeal II, Plea 1, paras 67-73.

⁴⁰⁹ https://acer.europa.eu/en/The_agency/Organisation/Board_of_Appeal/BoA_Public_Docs/Rules%20of%20Procedure_for%20publication.pdf.

which the appeal is brought, the notice of appeal shall be lodged in the language of the decision or in one of the official languages of the Community appearing in the submission which gave rise to the decision. The Chairperson acting on behalf of the Board of Appeal may accept to change the language of the case to another official language of the Community, if this is jointly requested by both parties and if this is compatible with the time constraint set in Article 28(2) of Regulation (EU) 2019/942. Any request to change the language of the case should be submitted within one calendar week after service of the notice of appeal to the parties of the proceeding in accordance with Article 8(6).”

1342. Appellant II claims that, under the Rules of Procedures of the Board of Appeal, NRAs are allowed to appeal in the official language(s) of their Member State, even when this language was not used in proceedings leading-up to ACER’s decision. It alleges that, given that, in practice, ACER systematically asks for language waivers from TSOs so it can use English, a different interpretation of Article 19(1) of the Rules of Procedure would deprive the right to appeal in the appellant’s official language of its effectiveness. Appellant II refers to Case T-187/98 *Rudolph v Commission* to sustain that claimants should be able to submit their claims in a language they master entirely. Appellant II also indicates that a subsequent translation into English of an appeal submitted in another language increases the appellants’ costs.
1343. When submitting its appeal, Appellant II submitted a letter in French to the Board of Appeal, in which it stated the following:
- « Au vu de la pratique de la Commission des recours, ce mémoire a été rédigé en anglais pour éviter une traduction ultérieure de celui-ci par mes services, comme cela a pu être imposé à d'autres régulateurs par le passé. Je regrette cependant cette pratique qui vient à rencontre de toutes les règles sur le respect de la diversité linguistique de l'Union et qui remet en cause les droits de la défense, et ce alors même que les règles de procédure de la Commission des recours prévoient explicitement la possibilité d'effectuer un recours dans une autre langue que l'anglais et a fortiori dans la langue de la partie qui saisit la Commission. Dès lors, je tiens à souligner que la soumission de ce mémoire en recours en anglais ne constitue en aucun cas un renoncement au droit de la CRE de faire appel des décisions de l'ACER devant la Commission des recours en français, ni à échanger tout document qu'elle estimerait utile dans cette langue. »*
- Freely translated into English: “In view of the practice of the Board of Appeal, the present notice of appeal has been drafted in English to avoid a subsequent translation of it by my services, as may have been imposed on other regulators in the past. However, I regret this practice, which runs counter to all the rules on respect for the linguistic diversity of the Union and which calls into question the rights of the defence, even though the rules of procedure of the Board of Appeal provide explicitly for the possibility of making an appeal in a language other than English and a fortiori in the language of the party bringing the matter before the Board of Appeal. Therefore, I would like to emphasize that the submission of the present notice of appeal in English does not in any way constitute a waiver of CRE's right to appeal ACER's decisions before the Board of Appeal in French, nor to exchange documents that it may consider useful in that language.”
1344. Appellant II explains that it has lodged its appeal before the Board of Appeal in English in order to avoid that the Board of Appeal requires it to subsequently translate it into English. It also stresses that it does not waive its right to appeal before the Board of Appeal in French.
1345. The Board of Appeal states, in this respect, that Appellant II voluntarily decided to submit its appeal in English. Any debate about the submission of the appeal in a different language is hypothetical and inadmissible *ratione materiae*.
1346. **It follows that the Sixteenth Consolidated Plea must be dismissed as unfounded.**

Seventeenth Consolidated Plea – Duty to duly reason.

1347. All parties agree that ACER has a duty to duly reason its decisions. This obligation is specifically foreseen in Article 14(7) ACER Regulation and also derives from Article 296 TFEU and the general principles of EU Law, including Article 41(2)(c) Charter. It has been confirmed by consistent case-law of European Courts⁴¹⁰. Pursuant to this duty, the reasoning followed by the Agency must be disclosed in a clear and unequivocal fashion, firstly to make the persons concerned aware of the reasons for the measure and thus enable them to defend their rights and to verify whether or not the decision is well-founded and, secondly, to allow

⁴¹⁰ Case T-700/14 *TVI v Commission* EU:T:2017:447, para 79.

European Courts to exercise their powers to review the lawfulness of the measure⁴¹¹. The Board of Appeal refers to its earlier decision-making practice⁴¹².

1348. Article 14(7) ACER Regulation states: “*Individual decisions of ACER shall state the reasons on which they are based for the purpose of allowing an appeal on the merits*”.
1349. Article 296 TFEU states: “*Legal acts shall state the reasons on which they are based and shall refer to any proposals, initiatives, recommendations, requests or opinions required by the Treaties.*”
1350. Article 41(1) and (2)(c) Charter states: “*Every person has the right to have his or her affairs handled impartially, fairly and within a reasonable time by the institutions, bodies, offices and agencies of the Union. 2. This right includes: (...) (c) the obligation of the administration to give reasons for its decisions.*”
1351. The Charter’s procedural rights are not absolute rights. Their purpose is not to create abstract procedural obstacles, but to protect the rights of the addressees and other persons concerned by a decision, as provided for by the regulations applicable to such decision and by relevant case law⁴¹³. It is settled case-law that the degree of precision of the reasoning must be weighed against practical realities as well as against time and available technical facilities for taking such decision⁴¹⁴. The obligation to duly reason decisions is meant to allow its addressees to understand the content and reasoning of the decision and to enable them to challenge the decisions, as well as to allow for the control of this reasoning in the context of judicial review.

17.1 Due reasoning of the RDCTCS scope.

1352. Appellant III⁴¹⁵ holds that the Contested Decision fails to give reasons why RAs exercised on internal NEs should be included in the RDCTCS scope.
1353. Appellant III⁴¹⁶ claims that the Contested Decision should have included a reference to cases T-283/19 and T-631/19 on the definition of internal CNEs and that not doing so infringes ACER’s duty to reason.
1354. Appellant VI⁴¹⁷ claims that ACER’s reliance on Article 76 SO to define the XNEs subject to cost-sharing under Article 74 CACM is based on inadequate and ineffective reasoning. It alleges that the Contested Decision does not sufficiently reason why the CNEs/XNEs defined for OS purposes (wider in scope) have to be identical to XNEs for cost-sharing of two of the possible class of RAs (RDCT), which is a commercial issue. Appellant VI alleges that paragraphs 64-65 and 67-72 of the Contested Decision do not contain sufficient reasoning.
1355. The Defence⁴¹⁸ responds that ACER duly reasoned its Contested Decision in compliance with Article 41 Charter.
1356. Section 6.2.2.1 of the Contested Decision entitled “*Determination of cross-border relevant network elements eligible for cost sharing*” (paragraphs 64 until 81) contains ACER’s clear and unequivocal reasoning behind the RDCTCS scope, covering 5 full pages of the decision.
1357. Regarding Appellant VI’s allegation that the Contested Decision lacks due reasoning as regards compliance with Article 74(2) CACM, the Board of Appeal observes that the Contested Decision dedicates an entire paragraph to the issue (paragraph 69): “*(69) Article 74(2) of the CACM Regulation requires the cost sharing methodology to determine cost sharing solutions for*

⁴¹¹ Case C-350/88 *Delacre and Others v Commission* ECLI:EU:C:1990:71, paras 15 and 16; Case T-217/01 *Forum des migrants v Commission* ECLI:EU:T:2003:106, para 68; and Case T-183/00 *Strabag Benelux v Council* EU:T:2003:36, para 55.

⁴¹² Board of Appeal Decisions A-002-2018, paras 101, 128 and 131; A-006-2109 paras 106-142; A-001-2018, paras 112-118; A-001-2020, paras 240, 252 and 263; A-002-2020, paras 241, 253 and 264; A-003-2020, paras 206 and 235; A-007-2020, paras 66 and 99; and A-008-2020, paras 331-343.

⁴¹³ Board of Appeal Decisions A-001-2017, para 124; A-001-2020, para 253; A-002-2020, para 254; A-007-2020, paras 67 and 101 and A-008-2020, paras 311 and 334.

⁴¹⁴ Board of Appeal Decisions A-001-2017, para 126; A-007-2020, paras 64, 67 and 101 and A-008-2020, paras 311 and 334.

⁴¹⁵ Appeal III, Plea 1, para 99.

⁴¹⁶ Appeal III, Plea 1, para 123.

⁴¹⁷ Appeal VI, Plea 7, paras 298-304.

⁴¹⁸ Defence, paras 674-687.

redispatching and countertrading actions of crossborder relevance. Since these actions are used to solve congestions on all cross-border relevant network elements and not just on a subset of them (see paragraph 65 above), it follows that omitting some cross-border relevant network elements from cost sharing would not comply with Article 74(2) of the CACM Regulation as it would not determine a cost sharing solution for some or part of redispatching and countertrading actions of cross-border relevance.”

1358. Regarding Appellant VI’s allegation that the Contested Decision lacks due reasoning as regards the compatibility with Article 16(13) ER, the Board of Appeal observes that the Contested Decision dedicates an entire paragraph to the issue (paragraph 68): *“Article 16(13) of the Electricity Regulation specifies a clear cost sharing solution (i.e. based on contributions from flows resulting from internal transactions) for congestion between two bidding zones observed. However, Article 16(13) of the Electricity Regulation does not specify that cost sharing should be applied only for congestion between two bidding zones observed (regardless of the exact interpretation of what the congestion between two bidding zones observed means). Therefore, Article 16(13) of the Electricity Regulation does not prevent, per se, that for network elements which would not be covered by the interpretation of the ‘congestion between two bidding zones observed’, the same cost sharing solution as for congestion between two bidding zones observed (or another cost sharing solution) can be applied.”*
1359. Regarding Appellant VI’s allegation that the Contested Decision lacks due reasoning as regards the necessity to limit the scope to a subset of XNEs as defined in the ROSC, the Board of Appeal observes that the Contested Decision dedicates an entire paragraph to the issue (paragraph 65): *“However, ACER understands that this assumption is not correct, since the methodology for coordinated security assessment, adopted pursuant to Article 75(1) of the SO Regulation, determines that regional operational security coordination, which is used as the basis for the activation of redispatching and countertrading actions of crossborder relevance, shall solve congestions only on cross-border relevant network elements. The regional operational security coordination process that is set out in the above-mentioned methodology will not aim to resolve congestions on network elements which are not cross-border relevant network elements and therefore no redispatching and countertrading actions of cross-border relevance will be activated for such elements. This understanding is confirmed by Article 8 of the proposal for the Core methodology for regional operational security coordination⁵ pursuant to Article 76 of the SO Regulation, which specifies that cross-border relevant network elements are secured network elements and these in turn are the only elements on which the congestions are being resolved by the regional operational security coordination.”*
1360. Taking account of the fact that the addressees of the Contested Decision are TSOs, which are sufficiently acquainted with the technicalities of the RDCTCS and in the light of the extensive consultations and hearing process on the RDCTCS scope (see First Consolidated Plea and Eighteenth Consolidated Plea), the Contested Decision’s reasoning is adequate in relation to the RDCTCS scope. ACER reasoned that its determination of the RDCTCS scope was necessary to comply with the applicable framework, which required the RDCTCS to include cost-sharing solutions for actions of CB relevance.
1361. Appellants III and VI’s pleas are detailed and demonstrate that they clearly and unequivocally understood the underlying reasoning of the Contested Decision on the RDCTCS scope. Rather than evidencing a lack of reasoning, the Appellants’ pleas express their dissatisfaction with the duly stated reasons set out in paragraphs 64-81 of the Contested Decision. This evidences that ACER provided Appellants III and VI with a clear and unequivocal reasoning, which they were able to understand and are now able to rebut, even though they are dissatisfied with its contents.
1362. As to Appellant III’s claim that the Contested Decision should have included a reference to T-283/19 *Germany v ACER* and T-631/19 *BNetzA v ACER* on the definition of internal CNEs, the Board of Appeal observes that (i) these references relate to applications lodged by Germany and Appellant IV against ACER Decision 02/2019, (ii) paragraph 71 of the Contested Decision expressly refers to ACER Decision 02/2019 to reason the scope of the RDCTCS and (iii) both cases are on-going and no judgments have been delivered by the GCEU with respect to said applications.
1363. The Board of Appeal concludes that the Agency did not fail to adequately state reasons in its Contested Decision.

17.2 Due reasoning of the threshold for acceptable LFs.

1364. Appellant III⁴¹⁹ claims that the common threshold for acceptable LFs is not properly reasoned as regards the need for a higher LF threshold for larger BZs with larger amounts of electricity generation from renewable energies.
1365. Appellant VI⁴²⁰ claims that ACER had no competence to impose the common threshold for legitimate LFs, that the Contested Decision should have mentioned the comments that Appellant VI sent to ACER by email on 22 October 2020⁴²¹, and that the common threshold is arbitrary and unsupported by adequate reasoning.
1366. The Defence⁴²² responds that the Contested Decision duly reasoned the imposition of a temporary legitimate LF threshold.
1367. Section 6.2.2.5 of the Contested Decision, entitled “*The threshold for legitimate level of LFs*” (paragraphs 107 until 122), contains ACER’s clear and unequivocal reasoning of its decision to set a temporary LF threshold, covering 4 full pages of the decision. The Contested Decision dedicates an entire paragraph to the concerns of some Core TSOs and NRAs from large BZ (paragraph 118):
- “(118) Some Core TSOs and regulatory authorities from large bidding zones also argued that equal splitting of the common threshold among all bidding zones is discriminatory towards larger bidding zones and instead a proportional splitting should be applied. ACER rejected such a proposal, because a proportional splitting of a threshold would make the concept of a loop flow threshold (as defined Article 16(13) of the Electricity Regulation) void, since the proportional splitting does not ensure that bidding zones which create very small loop flows and are considered as without structural congestion do not pay any costs. This is evident from the examples provided in Tables 1 and 2 below. In Table 1, equal splitting of the 10% common threshold to five bidding zones would result in an individual threshold equal to 2%. However, since bidding zone 1 does not use the whole individual threshold, the individual threshold can be increased by 2.33%, which results in exactly 10% of total sum of the loop flows below the individual threshold. In Table 1, the equal splitting of the common threshold ensures that bidding zones, which create small loop flows and are therefore considered as being without structural congestion, do not pay anything.”*
1368. Taking account of the fact that the addressees of the Contested Decision are TSOs, which are sufficiently acquainted with the technicalities of the RDCTCS and in the light of the extensive consultations and hearing process on the threshold for acceptable LFs (see Seventh Consolidated Plea and Eighteenth Consolidated Plea), the Contested Decision’s reasoning is adequate in relation to the determination of the common threshold for acceptable LFs. ACER reasoned that individual thresholds per BZ, based on a common LF threshold of 10%, was a necessary and appropriate temporary solution until Core TSOs would define and Core NRAs would approve the level of a more appropriate LF threshold in accordance with Article 16(13) ER. Even though it is impossible for ACER to fully reproduce the detailed technical analyses that led to the methodological choices adopted in the Contested Decision, it transpires from the clear and unequivocal reasoning underpinning its methodological choice for a common threshold for legitimate LFs that such analysis took place at an earlier stage in the proceedings. Said analysis is set out in detail in the Seventh Consolidated Plea.
1369. The claims of Appellants III and VI with regards to the temporary LF threshold are detailed and demonstrate that both Appellants clearly and unequivocally understood the underlying reasoning of the Contested Decision on the temporary legitimate LF threshold. The pleas of both Appellants reiterate the arguments that both Core TSOs tabled throughout the proceedings leading-up to the Contested Decision. The appeals express the Appellants’ dissatisfaction with the duly stated reasons set out in paragraphs 107-122 of the Contested Decision. This evidences that ACER provided the Appellants with a clear and unequivocal reasoning, which they were able to understand and are now able to rebut, even though they are dissatisfied with its contents.

⁴¹⁹ Appeal III, Plea 2, para 153.

⁴²⁰ Appeal VI, Plea 7, para 287-290.

⁴²¹ Annex A.2.6 to Appeal VI.

⁴²² Defence, paras 639-647.

1370. As to Appellant VI's claim that the Contested Decision should have mentioned its comments sent by email to ACER on 22 October 2020, the Board of Appeal notes that it is impossible for ACER to reproduce all stakeholder exchanges of the bottom-up decision-making process that led to the methodological choices adopted in the Contested Decision.
1371. The Board of Appeal concludes that the Agency did not fail to adequately state reasons in its Contested Decision.

17.3 Due reasoning of the prioritisation of LFs above the threshold.

1372. Appellant VI⁴²³ claims that, despite clear deficiencies of Core TSOs' Experimentation Report, ACER used the outputs of the Experimentation Report for its analysis of the financial impacts on TSOs of polluter flow thresholds⁴²⁴. It refers to email correspondence by ACER of June 2020 referring to test results based on All Core TSOs' Experimentation Report⁴²⁵. Appellant VI furthermore claims that the Contested Decision does not reflect a balanced assessment of ACER's proportionality analysis in relation to the prioritisation of LFs above the threshold, i.e. an analysis that would weigh the expected financial impacts on TSOs responsible for LFs and their network users and customers against the aims pursued by the Contested Decision. Appellant VI refers to its arguments set out in the Sixth Consolidated Plea and concludes that ACER fails to provide coherent reasons for the prioritisation of LFs above the threshold.
1373. The Defence⁴²⁶ responds that the Contested Decision is duly reasoned with respect to the prioritisation of LFs above the threshold.
1374. Section 6.2.2.6 of the Contested Decision, entitled "*Priority of flow components*" (paragraphs 123 until 136), contains ACER's clear and unequivocal reasoning behind the decision to prioritise LFs above the threshold, covering 4 full pages of the decision. The Contested Decision dedicates several paragraphs to explain All Core TSOs' Experimentation Report. As confirmed by paragraph 129 of the Contested Decision, ACER carried out its own simulations, based on a variety of parameters, to test All Core TSOs' Experimentation Report: "*ACER carefully evaluated different arguments from Core TSOs and regulatory authorities, analysed possible options and performed the simulations of investigated options based on the data used in the Experimentation report. While ACER recognises some validity of arguments of both groups of Core TSOs and regulatory authorities, it considers that the arguments of the majority of TSOs and regulatory authorities are stronger in this specific case*".
1375. Taking account of the fact that the addressees of the Contested Decision are TSOs, which are sufficiently acquainted with the technicalities of the RDCTCS and in the light of the extensive consultations and hearing process on the prioritisation of LFs above the threshold (see Sixth Consolidated Plea and Eighteenth Consolidated Plea), the Contested Decision's reasoning is adequate in relation to the prioritisation of LFs above the threshold. ACER reasoned that a priority stack that prioritises LFs above the threshold as the primary contributors to the congestion is necessary to attain the objectives set by the CACM and the ER as it creates the correct incentives to manage congestion and fosters the efficient development and operation of the EU interconnected system and electricity market in the long term, is consistent with the responsibilities and liabilities of Core TSOs, ensures a fair distribution of costs and benefits between Core TSOs, facilitates adherence to the general principles of CM and complies with the principles of transparency and non-discrimination.
1376. Appellant VI's claim on the prioritisation of LFs above the threshold is detailed and demonstrates that it clearly and unequivocally understood the underlying reasoning of the Contested Decision on the prioritisation of LFs above the threshold.
1377. Appellant VI's plea reiterates the arguments that it tabled throughout the proceedings leading-up to the Contested Decision. The appeal expresses Appellant VI's dissatisfaction with the

⁴²³ Appeal VI, Plea 7, paras 280-286.

⁴²⁴ Annex A.3.1 to Appeal VI.

⁴²⁵ Annex A.2.7 to Appeal VI.

⁴²⁶ Defence, paras 625-638.

duly stated reasons set out in paragraphs 123-136 of the Contested Decision. This evidences that ACER provided the Appellant with a clear and unequivocal reasoning, which it was able to understand and is now able to rebut, even though it is dissatisfied with its contents.

1378. The Board of Appeal concludes that the Agency did not fail to adequately state reasons in its Contested Decision.

17.4 Due reasoning of the choice of the PFC method.

1379. Appellant V⁴²⁷ considers that the Contested Decision did not sufficiently reason the choice of the PFC method. Appellant V raises procedural concerns regarding ACER's explanation of its choice for the PFC approach and use of GSKs, infringing Articles 14(7) ACER Regulation and 296 TFEU and the general principles of EU Law including Article 41(2)(c) Charter. Appellant V claims that the Contested Decision's choice for the PFC method was motivated by time pressure rather than due analysis.

1380. The Defence⁴²⁸ states that the Contested Decision is duly reasoned with respect to flow decomposition.

1381. First, the Contested Decision, which has an Annex Ia with the marked-up version of All Core TSOs' RDCTCS Proposal, contains an explanation in Section 6.2.2.3, entitled "*Specification of flow components*", containing ACER's clear and unequivocal reasoning behind the decision to decompose flows on the basis of the PFC method. Far from being succinct, the explanation of Section 6.2.2.3 covers 3 pages of the decision. In this section, ACER sets out in detail all modifications that it brought to All Core TSOs' RDCTCS Proposal on flow decomposition and their underlying reasoning. In so doing, ACER sets out the PFC and FLD methods, compares them and explains why it chose to use the PFC method. Paragraphs (96), (97) and (98) of the Contested Decision read as follows:

"(96) During the development of the Proposal, Core TSOs considered two possible methods for the flow decomposition. The first method was power flow colouring (PFC) and the second was full line decomposition (FLD). Both methods in general follow a two-step approach for the determination of flow components, where in the first step, for each node in the common grid model, sources (i.e. positive nodal injections) and sinks (i.e. negative nodal injections) are split into components which cause particular flow components and in a second step these partial injections are multiplied with nodal power transfer distribution factors (PTDFs) that convert these nodal injections into flows on network elements, i.e. loop flows, internal flows and allocated flows.

(97) The power flow colouring (PFC) method firstly applies a splitting of source and sink injections into injections reflecting cross-zonal exchanges and injections reflecting electricity exchanges internal to bidding zones. This splitting is done based on a generation and load shift key, which determines the share of the total export or import of a bidding zone that is attributed to each individual node and thereby determines source and sink injections reflecting the cross-zonal exchanges. The difference between total injections and injections related to cross-zonal exchanges then determine the injections related to internal exchanges. The allocated flow is calculated by multiplying the cross-zonal injections with nodal PTDFs and summing up contributions from all nodes in all bidding zones per relevant network element. Internal flows and loop flows are determined by multiplying internal injections with corresponding PTDFs and summing up contributions from all nodes per each bidding zone per relevant network element.

(98) The full line decomposition (FLD) method performs the pairing of source and sink injections based on electrical distance, without prior decomposing each source and sink injections that would be predefined to cause internal and cross-zonal component of flows. This method calculates the flow types per network element by multiplying the corresponding nodal injections with nodal PTDFs. The flow types for individual network elements are calculated by filtering and summing the flow contributions according to the flow type definitions for the loop flows, internal flows and allocated flows."

1382. Second, notwithstanding the fact that, on 27 March 2020 (when All Core NRAs referred All Core TSOs' Proposal to ACER), the majority of All Core TSOs favoured the PFC method, as evidenced by their Experimentation Report⁴²⁹ and Non-Paper⁴³⁰, the adequate method for flow decomposition was thoroughly analysed throughout the proceedings leading-up to the

⁴²⁷ Appeal V, Plea 2, Sub-plea 3, paras 139-145.

⁴²⁸ Defence, paras 413-415.

⁴²⁹ All Core TSOs' Experimentation Report, Annex 23 to the Defence, p. 15.

⁴³⁰ All Core TSOs' Non Paper, Annex 79 to the Defence, p.41-46.

Contested Decision, as set out in the Third Consolidated Plea. This is also reflected in the Contested Decision (paragraph 101):

“(101) In the Experimentation report, Core TSOs were using the power flow colouring (PFC) method as the basis for the flow decomposition, since its representation of flow components is better reflecting the nature of the zonal European market model and provides more intuitive results. Thus, the majority of Core TSOs and regulatory authorities proposed to use this method for power flow decomposition. ACER carefully analysed both methods and consulted also with TSOs and regulatory authorities, which supported the full line decomposition method. Nevertheless, based on all the information gathered, ACER concluded that power flow colouring is more suitable for the zonal market model and is consistent with the capacity calculation when calculating allocated flows, which is not the case for the full line decomposition method. For this reason ACER included in the cost sharing methodology the flow decomposition based on power flow colouring.”

1383. Taking account of the fact that the addressees of the Contested Decision are TSOs, which are sufficiently acquainted with the technicalities of the RDCTCS and in the light of the extensive consultations and hearing process on flow decomposition (see Third Consolidated Plea and Eighteenth Consolidated Plea), the Contested Decision’s reasoning is adequate in relation to the use of the PFC method. ACER reasoned that the PFC method was more suitable for the zonal market model and was consistent with CC when calculating AFs, contrary to the FLD method. Even though it is impossible for ACER to fully reproduce the detailed technical analyses that led to the methodological choices of the Contested Decision, it transpires from the clear and unequivocal reasoning underpinning its methodological choice for flow decomposition on the basis of the PFC method that such analysis took place at an earlier stage in the proceedings. Said analysis is set out in detail in the Third Consolidated Plea.
1384. Appellant V’s Second Plea on flow decomposition is detailed and demonstrates that Appellant V clearly and unequivocally understood the underlying reasoning of the Contested Decision on the use of the PFC method. The Plea provides a detailed reiteration of the arguments that Appellant V provided throughout the proceedings leading-up to the Contested Decision and expresses its dissatisfaction with the duly stated reasons set out in paragraphs 92-102 of the Contested Decision. This evidences that ACER provided Appellant V with a clear and unequivocal reasoning, which it was able to understand and is now able to rebut, even though it is dissatisfied with its content. In this sense, Appellant V’s ability to pinpoint technical errata in the Contested Decision’s reasoning reinforces the fact that the Contested Decision duly reasoned its choice, that Appellant V was able to understand this reasoning and that Appellant V’s claim expresses its dissatisfaction with the said choice.
1385. The Board of Appeal concludes that the Agency did not fail to adequately state reasons in its Contested Decision.

17.5 Due reasoning of the Contested Decision in general.

1386. Appellant VI⁴³¹ claims that the Contested Decision’s RDCTCS “*was motivated solely by ACER’s desire to win support from two-thirds of the members of the Board of Regulators and discarded the compromise discussed with CRE in July 2020.*” It refers to email correspondence of August and October 2020 between Appellant VI and ACER⁴³².
1387. The Defence⁴³³ responds that the Contested Decision is duly motivated in compliance with Article 41 Charter and that, in accordance with the ACER Regulation, ACER is under an obligation to obtain a favourable opinion of the BoR.
1388. Appellant VI refers to paragraphs 73-74, 106, 122 and 136 of the Contested Decision and alleges that these paragraphs demonstrate that ACER’s sole motivation was to obtain the support of the necessary majority of NRAs in the BoR.
1389. On the RDCTCS scope, paragraphs 73-74 of the Contested Decision state: “*During the proceedings on this Decision, ACER explored whether regulatory authorities could support the interpretation that only network elements concerned by the congestion as defined in Article 2(4) of the Electricity Regulation*

⁴³¹ Appeal VI, Plea 7, paras 277-279, paras 291-297.

⁴³² Annexes A.2.5 and A.2.6 to Appeal VI.

⁴³³ Defence, paras 657-687.

are eligible for cost sharing (as outlined in paragraph 67 above). The responses from the majority of regulatory authorities showed that a Decision adopted based on this interpretation could not receive the required favourable opinion of the ACER's Board of Regulators. Thus, only a Decision where all cross-border relevant network elements are eligible for cost sharing was able to gather the required favourable opinion of the ACER's Board of Regulators. (74) Based on the above, ACER defined in Article 3 of the cost sharing methodology that all cross-border relevant network elements shall be subject to cost sharing."

1390. On netting, paragraph 106 of the Contested Decision states: "During the proceedings on this Decision, ACER explored whether regulatory authorities could support the netting of relieving flows in the form of equal netting where the equal share of relieving flows reduce all burdening flow components. The responses from the majority of regulatory authorities showed that a Decision adopted based on such proposal for netting could not receive the required favourable opinion of the ACER's Board of Regulators. Thus, only a Decision where no netting of relieving flows is applied was able to gather the required favourable opinion of the ACER's Board of Regulators."
1391. On the threshold for legitimate LFs, paragraph 122 of the Contested Decision states: "During the proceedings on this Decision, ACER explored whether regulatory authorities could support a higher common loop flow threshold equal to 15% in order to take into account the concerns of Core TSOs and regulatory authorities from large bidding zones (see paragraphs 115 and 116 above). The responses from the majority of regulatory authorities showed that a Decision adopted based on such proposal for common loop flow threshold could not receive the required favourable opinion of the PUBLIC Decision No 30/2020 Page 31 of 41 ACER's Board of Regulators. Thus, only a Decision adopting a common loop flow threshold equal to 10% or lower was able to gather the required favourable opinion of the ACER's Board of Regulators."
1392. On the priority of LFs above the threshold, paragraph 136 of the Contested Decision states: "During the proceedings on this Decision, ACER explored whether regulatory authorities could support a compromise solution between Option 1 and Option 2 (as described above) where part (percentage) of internal flows would be treated with equal priority as loop flows and the remaining part with a second priority. The responses from the majority of regulatory authorities showed that a Decision adopted based on such proposal for priority of flow components could not receive the required favourable opinion of the ACER's Board of Regulators. Thus, only a Decision adopting Option 1 (as described above) was able to gather the required favourable opinion of the ACER's Board of Regulators."
1393. First, as shown above in Sub-pleas 17.1, 17.2 and 17.3, the excerpts quoted by Appellant VI do not represent the full reasoning of the Contested Decision as regards the RDCTCS scope, the netting choice, the legitimate LF threshold and the prioritisation of LFs above the threshold. Section 6.2.2.1 of the Contested Decision entitled "Determination of cross-border relevant network elements eligible for cost sharing" (paragraphs 64 until 81) contains ACER's clear and unequivocal reasoning behind the RDCTCS scope, covering 5 full pages of the decision. Section 6.2.2.5 of the Contested Decision entitled "The threshold for legitimate level of LFs" (paragraphs 107 until 122) contains ACER's clear and unequivocal reasoning behind the decision to set a temporary legitimate LF threshold, covering 4 full pages of the decision. Section 6.2.2.6 of the Contested Decision entitled "Priority of flow components" (paragraphs 123 until 136) contains ACER's clear and unequivocal reasoning behind the decision to prioritise LFs above the threshold, covering 4 full pages of the decision. Section 6.2.2.3 entitled "Specification of flow components" (paragraphs 92 until 102) contains ACER's clear and unequivocal reasoning behind the decision to decompose flows on the basis of the PFC method, covering 3 full pages of the decision.
1394. Regarding netting, the excerpt quoted by Appellant VI does not represent the full reasoning of the Contested Decision. Section 6.2.24 of the Contested Decision entitled "Netting of flow components in the opposite direction to the congestion" (paragraphs 103 until 106) contains ACER's clear and unequivocal reasoning behind the decision of a netting process with respect to the calculation of the overload per NE without an additional netting process for the allocation of flow types to the overload, covering a full page of the decision:
(103) Article 8(4) of the Proposal specifies that a cost sharing solution must apply the netting of flow components that are opposite to the direction of congestion (i.e. relieving flows), but it does not specify how exactly this netting is applied. In the Experimentation report and Non-paper of Core TSOs, Core TSOs have analysed several solutions that fall into two categories. The first category determines which relieving flows are netted with which burdening flows, and here TSOs presented that first the relieving flows of the same category are netted (e.g. relieving loop flows reduce burdening loop flows) and then the remaining relieving flows, if still present, reduce all burdening flows. The second category determines how flows are netted and here the TSOs

presented three solutions: (i) all relieving flows reduce all burdening flows proportionally to the size of burdening flows, (ii) all relieving flows reduce all burdening flows equally, such that each burdening flow component is reduced by the same amount and (iii) vertical shift by which the relieving flows reduce burdening flows at the bottom of the order stack, which is determined by the priorities of flows as determined in Section 4.5 of the TSOs' Explanatory document.

(104) After careful analysis of all options presented by the TSOs and the fact that the TSOs could not agree on any of the presented options, ACER concluded that the cost sharing methodology does not require the netting of relieving flows. While netting could technically be applied, the cost sharing methodology can also work without any netting of relieving flows.

(105) The reason for such decision is twofold. First, neither the CACM Regulation nor the Electricity Regulation explicitly requires the netting of relieving flows for establishing a cost sharing solution. Second, Article 16(13) of the Electricity Regulation only requires the identification of flows which contribute to congestion as only such flows shall be considered for cost sharing. The flows which contribute to congestion are only burdening flows whereas the relieving flows do not contribute to congestion. Furthermore, reducing burdening flows by the relieving flows would artificially reduce the contribution of burdening flows to congestion and thereby would not comply with the requirements of Article 16(13) of the Electricity Regulation, which require the identification of flows which contribute to congestion without any reductions. For this reason, ACER removed from the cost sharing methodology the requirement to net the relieving flows as it is not required for cost sharing.

(106) During the proceedings on this Decision, ACER explored whether regulatory authorities could support the netting of relieving flows in the form of equal netting where the equal share of relieving flows reduce all burdening flow components. The responses from the majority of regulatory authorities showed that a Decision adopted based on such proposal for netting could not receive the required favourable opinion of the ACER's Board of Regulators. Thus, only a Decision where no netting of relieving flows is applied was able to gather the required favourable opinion of the ACER's Board of Regulators."

1395. Appellant VI's allegations that the Contested Decision "was motivated solely by ACER's desire to win support from two-thirds of the members of the Board of Regulators and discarded the compromise discussed with CRE in July 2020", was "wholly arbitrary" or "motivated only by considerations of expediency" are therefore, flawed. The Contested Decision is supported by a coherent and objective evidence-based assessment in compliance with the applicable regulatory framework, as evidenced throughout the present decision. As set out by the Defence, the obtainment of a favourable opinion from the BoR, which is required under the ACER Regulation, has not prevented the Contested Decision and its RDCTCS to be fully compliant with the relevant legal framework.
1396. Second, Appellant VI's claim expresses its dissatisfaction with the multipartite bottom-up decision-making process for the adoption of the decision, imposed by the applicable regulatory framework. It does not evidence a failure of due reasoning of the Contested Decision.
1397. As set out throughout the present decision, the decision-making process leading-up to the Contested Decision is a market-driven, bottom-up, gradual, step-based and multipartite process, in which, at different points in time, various national and EU stakeholders are called on to participate and whereby all stakeholders involved exchange opinions and provide input to attain an optimal solution that ensures compliance with the applicable regulatory framework. ACER's powers have to be situated within this decision-making process. The Contested Decision is the outcome of ACER's decision-making process, including an extensive consultation process with All Core TSOs and All Core NRAs, the involvement of ACER's electricity working group and ACER's BoR (composed of All NRAs), two-thirds of which decide on whether ACER's draft decision are to be approved. ACER is an agency that is meant to promote cooperation between NRAs
1398. In this bottom-up decision-making process, ACER closely cooperated with All Core NRAs and Core TSOs and further consulted on the amendments to the proposed RDCTCS during numerous teleconferences and through various exchanges of draft decisions. This is demonstrated by paragraph (11) of the Contested Decision:
- 9 April 2020: teleconference with all Core regulatory authorities;
 - 16 April 2020: teleconference with all Core regulatory authorities and TSOs;
 - 30 April 2020: teleconference with all Core regulatory authorities and TSOs;
 - 7 May 2020: teleconference with all Core regulatory authorities;
 - 14 May 2020: teleconference with all Core regulatory authorities and TSOs;

- 19 May 2020: teleconference with all Core regulatory authorities;
- 25 May 2020: teleconference with all Core regulatory authorities and TSOs;
- 5 June 2020: teleconference with all Core regulatory authorities;
- 8 June 2020: ACER circulated a draft of the proposed amendments to the cost sharing methodology to all Core regulatory authorities and TSOs;
- 12 June 2020: teleconference with all Core regulatory authorities and TSOs;
- 24 June 2020: ACER circulated a draft of the proposed amendments to the cost sharing methodology to all Core regulatory authorities and TSOs;
- 24 June 2020: Discussion with all regulatory authorities in the framework of ACER electricity working group ('AEWG');
- 25 June 2020: teleconference with all Core regulatory authorities and TSOs;
- 9 July 2020: teleconference with all Core regulatory authorities;
- 10 July 2020: ACER circulated a draft of the proposed amendments to the cost sharing methodology to all Core regulatory authorities and TSOs;
- 15 July 2020: teleconference with all Core regulatory authorities and TSOs;
- 24 July 2020: teleconference with all Core TSOs on flow decomposition;
- 27 July 2020: ACER circulated a draft of the proposed amendments to the cost sharing methodology to all Core regulatory authorities and TSOs;
- 28 July 2020: teleconference with all Core regulatory authorities and TSOs;
- 31 July 2020: ACER circulated the draft of the cost sharing methodology to all Core regulatory authorities and TSOs, including mapping options;
- 6 August 2020: ACER circulated the proposal for the cost sharing methodology to all Core regulatory authorities and TSOs for hearing phase;
- During the hearing phase, ACER held several meetings with regulatory authorities and TSOs discussing their specific concerns, such as monitoring, usage of generation shift key and mapping;
- 20 August 2020: At the end of the hearing phase, ACER circulated the updated proposal for the cost sharing methodology which included all the comments received during the hearing as well as ACER's responses to how these comments were tackled;
- 3 September 2020: Discussion with all regulatory authorities in the framework of ACER electricity working group ('AEWG');
- 25 September 2020: the Director's proposal of a decision did not receive a favourable opinion from the Board of Regulators;
- 28 October 2020: Discussion with all regulatory authorities in the framework of AEWG."

1399. Article 22(1) ACER Regulation states: "The Board of Regulators shall act by a two-thirds majority of the members present, with one vote for each member."

1400. The Contested Decision expressly stipulates in its recital and paragraph 11 that the first draft RDCTCS decision of ACER's Director of 25 September 2020 did not receive the necessary favourable opinion of the BoR (which requires a two-thirds majority), but that the second draft RDCTCS decision of ACER's Director of 18 November 2020 received the necessary favourable opinion of the BoR. The Board of Appeal observes that, without the BoR's favourable opinion, the Contested Decision could not have been adopted.

1401. Appellant VI refers to Article 24 ACER Regulation:

"1. The Director shall: (...) (c) draft, consult upon, adopt and publish (...) decisions; (...).

2. For the purposes of point (c) of paragraph 1 of this Article, opinions, recommendations and decisions referred to in Article 3(1), Articles 4 to 8, Article 9(1) and (3), Article 10, point (c) of Article 11, Article 13, Article 15(4), and Articles 30 and 43 shall be adopted only after having obtained the favourable opinion of the Board of Regulators. Before submitting draft opinions, recommendations or decisions to a vote by the Board of Regulators, the Director shall submit proposals for the draft opinions, recommendations or decisions to the relevant working group for consultation sufficiently in advance.

The Director:

(a) shall take the comments and amendments of the Board of Regulators into account and shall resubmit the revised draft opinion, recommendation or decision to the Board of Regulators for a favourable opinion;

(b) may withdraw submitted draft opinions, recommendations or decisions provided that the Director submits a duly justified written explanation where the Director disagrees with the amendments submitted by the Board of Regulators.

In the case of a withdrawal of a draft opinion, recommendation or decision, the Director may issue a new draft opinion, recommendation or decision following the procedure set out in point (a) of Article 22(5) and in the second subparagraph of this paragraph. For the purposes of point (a) of the third subparagraph of this

paragraph, where the Director deviates from or rejects the comments and amendments received from the Board of Regulators, the Director shall also provide a duly justified written explanation. If the Board of Regulators does not give a favourable opinion on the resubmitted text of the draft opinion, recommendation or decision because its comments and amendments were not adequately reflected in the resubmitted text, the Director may revise the text of the draft opinion, recommendation or decision further in accordance with the amendments and comments proposed by the Board of Regulators in order to obtain its favourable opinion, without having to consult the relevant working group again or having to provide additional written reasons.”

1402. Appellant VI also refers to Recital (36) ACER Regulation: “The Director should be responsible for drafting and adopting (...) decisions. Certain opinions, recommendations and decisions referred to in point (a) of Article 22(5) and Article 24(2) should require the favourable opinion of the Board of Regulators before they are adopted. The Board of Regulators should be able to provide opinions on, and, where appropriate, comments on and amendments to the Director's text proposals, which the Director should take into account. Where the Director deviates from or rejects the comments and amendments submitted by the Board of Regulators, the Director should provide a duly justified written reasoning to facilitate a constructive dialogue. If the Board of Regulators does not give a favourable opinion on a re-submitted text, the Director should have the possibility of revising the text further in line with the amendments and comments proposed by the Board of Regulators, in order to obtain their favourable opinion. The Director should have the possibility of withdrawing submitted draft opinions, recommendations and decisions where the Director disagrees with the amendments submitted by the Board of Regulators and issuing a new text following certain procedures referred to in point (a) of Article 22(5) and Article 24(2). The Director should have the possibility of seeking the favourable opinion of the Board of Regulators on a new or revised draft text at any stage of the procedure”.
1403. Article 24 and Recital (36) ACER Regulation set out the functions of ACER’s Director within the bottom-up decision-making process.
1404. The Contested Decision evidences that ACER’s Director complied at all times with the functions set out in those provisions, and duly submitted, in this context, a first draft to the BoR in September 2020 and, following its disapproval, a second draft in November 2020. The latter, which received a favourable opinion by the BoR, became the Contested Decision and fully complies with the applicable legal framework. Appellant VI does not provide any evidence that ACER’s Director did not comply with said provisions.
1405. Furthermore, as set out in the Fourteenth Consolidated Plea, ACER, as an EU agency, is required to interpret EU Law in a systematic approach and to observe the principle of sincere cooperation with the EU Member States, including the NRAs. The principle of sincere cooperation between ACER and the NRAs derives from Articles 4(3) and (13) TEU and are highlighted in Recitals (2), (4), (10), (16), (22), (23), (30) and 45 and Article 1 of the ACER Regulation. ACER is an agency that is meant to promote cooperation between NRAs. ACER coordinates NRAs’ actions and mediates and settles disagreements between NRAs.
1406. The Board of Appeal observes, in this respect, that in BoA Decisions A-001-2020, A-002-2020 and A-008-2020, Appellant VI appealed ACER Decisions 02/2020, 03/2020 and 13/2020 essentially because of an alleged failure to take account of All NRAs’ views and that it has appealed BoA Decisions A-001-2020 and A-002-2020 on these grounds before the GCEU in Cases T-606/20 and T-607/20. It is inconsistent to appeal ACER Decisions (and BoA Decisions upholding them) due to an alleged failure to take account of NRAs’ views, on the one hand, and to also appeal ACER Decisions because they take account of NRA’s views (through the mandatory procedural step of the BoR), on the other hand.
1407. Finally, Appellant VI alleges that “ACER adopted a position on the network elements eligible for cost recovery which it plainly regarded as inconsistent with the Electricity Regulation in order to win the Board of Regulators’ backing”.
1408. The Board of Appeal highlights below that ACER does not consider the Contested Decision as being inconsistent with the ER but, on the contrary, that it is consistent with the ER, as demonstrated by the excerpts of the Contested Decision:
- “6.2.2 Assessment of the cost sharing solution
(55) Article 74(2) of the CACM Regulation requires the Proposal to determine cost sharing solutions for actions of cross-border relevance. **In accordance with Article 16(13) of the Electricity Regulation** the cost sharing solutions for congestions between two bidding zones observed shall be based on the analysis to what extent flows resulting from transactions internal to bidding zones contribute to such congestions.

- (61) Finally, Article 74(2) of the CACM Regulation and **Article 16(13) of the Electricity Regulation** require a cost sharing solution to determine the sharing between TSOs, but the Proposal does not specify how the shares of each bidding zone are split between TSOs within each bidding zone.
- (62) **The Proposal therefore does not comply with Article 74(2) of the CACM Regulation and Article 16(13) of the Electricity Regulation** as it does not specify all the necessary elements to determine the cost sharing solution for sharing the costs of redispatching and countertrading actions of cross-border relevance among Core TSOs. The Proposal therefore needs to be amended in the following ways(...)

6.2.2.1. Determination of cross-border relevant network elements eligible for cost sharing

- (68) **Article 16(13) of the Electricity Regulation specifies a clear cost sharing solution** (i.e. based on contributions from flows resulting from internal transactions) for congestion between two bidding zones observed. However, **Article 16(13) of the Electricity Regulation does not specify** that cost sharing should be applied only for congestion between two bidding zones observed (regardless of the exact interpretation of what the congestion between two bidding zones observed means). Therefore, **Article 16(13) of the Electricity Regulation does not prevent, per se**, that for network elements which would not be covered by the interpretation of the 'congestion between two bidding zones observed', the same cost sharing solution as for congestion between two bidding zones observed (or another cost sharing solution) can be applied.
- (71) Excluding some cross-border relevant network elements from cost sharing would also contradict the general principles of congestion management **in accordance with Article 16(1) of the Electricity Regulation** by which network congestion problems should be addressed with non-discriminatory market-based solutions which give efficient economic signals to the market participants and transmission system operators involved. This general principle was applied in ACER Decision 02/2019 of 21 February 2019 on the Core CCR TSOs' proposals for the regional design of the day-ahead and intraday common capacity calculation methodologies. Articles 5 of Annexes I and II of this Decision set out the requirements for Core TSOs to continuously monitor and identify the most efficient congestion management method for congestions on internal network elements, among which are capacity calculation, remedial actions, reconfiguration of bidding zones and network investments. The solution by which congestion problems can be addressed with remedial actions crucially depends on the coordination of remedial actions and related cost-sharing. Thus, in the absence of costsharing for specific congested network elements, remedial actions could no longer be considered as an alternative congestion management method for these elements. As a consequence, this would prevent efficient congestion management **as required by Article 16(1) of the Electricity Regulation**.
- (72) In view of this context, **Article 16(13) of the Electricity Regulation** should be interpreted as not excluding a cost sharing solution that applies to all cross-border relevant network elements.

Cross-border relevant network elements concerned by the action plans

- (77) ACER carefully evaluated these positions and the specific situation of the network elements concerned by the action plan. First, ACER observed that the claim that internal network elements concerned by the action plan cannot be considered as cross-border relevant is **not supported by Article 15(3) of the Electricity Regulation** nor by any other relevant legal provision. Second, ACER notes that indeed **Article 15(3) of the Electricity Regulation limits** the exclusion of such network elements from cost sharing only to the extent where such costs have occurred for the purpose of achieving the linear trajectory **referred to in Article 15(2) of the same Regulation** or make available the required level of cross-zonal capacity **in accordance with Article 16(8) of the same Regulation**.
- (79) ACER understands that the remedial actions, which are required to address congestions caused by loop flows from other bidding zones cannot be considered as remedial actions necessary to achieve the linear trajectory **as stipulated by Article 15(3) of the Electricity Regulation**. This is because the action plan and the related linear trajectory are designed to address the congestion identified within the bidding zone(s) of the concerned Member State **in accordance with Article 15(1) and (2) of the Electricity Regulation**. The action plan and linear trajectory therefore reflect the (high level of) loop flows and internal flow caused by the bidding zone of such Member State and they are not designed to solve the physical congestion problems that are caused by loop flows from other bidding zones. The action plan should gradually reduce the level of loop flows and internal flow resulting from the bidding zone of a Member State applying the action plan, which should allow for a gradual increase of cross-zonal capacities. However, this may not be possible if during this period the loop flows from other bidding zones would increase and no cost sharing with polluter-pays principle would be applied for these loop flows. Excluding all network elements concerned by the action plan from the cost sharing would not allow the Member State applying the action plan to increase cross-zonal capacities, because there would be no cost sharing for congestions caused by loop flows originating from neighbouring bidding zones. Such a solution would, on the other hand, provide perverse incentives to neighbouring Member States. With this respect, **Article 15(3) of the Electricity Regulation does not aim** at contradicting the polluter pays principle in case of action plans, but rather to safeguard and reinforce it.
- (80) In conclusion, the adopted cost sharing methodology, which effectively shares the costs of remedial actions, which are related only to congestions caused by loop flows, ensures that all remedial actions necessary to

achieve the linear trajectory **as stipulated by Article 15(3) of the Electricity Regulation** are always borne by the TSOs of Member States where such network elements are located. Therefore, the adopted cost sharing methodology ensures that the remedial actions necessary to achieve the linear trajectory on network elements concerned by the action plan **as stipulated by Article 15(3) of the Electricity Regulation** are always borne by the Member States implementing such action plans.

6.2.2.4. Netting of flow components in the opposite direction to the congestion

(105) The reason for such decision is twofold. First, neither the CACM Regulation **nor the Electricity Regulation explicitly requires** the netting of relieving flows for establishing a cost sharing solution. Second, **Article 16(13) of the Electricity Regulation only requires** the identification of flows which contribute to congestion as only such flows shall be considered for cost sharing. The flows which contribute to congestion are only burdening flows whereas the relieving flows do not contribute to congestion. Furthermore, reducing burdening flows by the relieving flows would artificially reduce the contribution of burdening flows to congestion and thereby **would not comply with the requirements of Article 16(13) of the Electricity Regulation**, which require the identification of flows which contribute to congestion without any reductions. For this reason, ACER removed from the cost sharing methodology the requirement to net the relieving flows as it is not required for cost sharing.

6.2.2.5. The threshold for legitimate level of loop flows

(108) **In accordance with Article 16(13) of the Electricity Regulation**, the cost sharing methodology must exclude from cost sharing the flows resulting from transactions internal to bidding zones that are below the level that could be expected without structural congestion in a bidding zone (i.e. the loop flow threshold). This means that loop flows from each bidding zone must be split into two components, one below the threshold and one above the threshold.

(109) The threshold for loop flows is an indispensable part of the cost sharing methodology, **because Article 16(13) of the Electricity Regulation** establishes a principle by which loop flows, which are expected in bidding zones without structural congestions should not be considered as contributing to congestion and therefore penalised. This principle reflects the fundamental nature of zonal electricity market model that even in an optimal bidding zone configuration, some levels of loop flows would still persist and are therefore inherent in any zonal market model. **Article 16(13) of the Electricity Regulation therefore establishes** a rule by which this normal level of loop flows is legitimate and should not be penalised.

(110) In order to define the loop flow threshold, **Article 16(13) of the Electricity Regulation requires** this threshold needs to be jointly analysed and defined by all transmission system operators in a capacity calculation region for each individual bidding zone border, and be subject to the approval of all regulatory authorities in the capacity calculation region. By the time of the adoption of this decision, TSOs have not performed such an analysis and no approval of Core regulatory authorities could be granted.

(112) ACER investigated options to perform such an analysis itself. However, such an analysis would require first a determination of a situation in which no structural congestion would appear in any bidding zone **as required by Article 16(13) of the Electricity Regulation**. Such situation would *inter alia* require an investigation of network investments and alternative bidding zone configurations, which would address and remove all structural congestions in all bidding zones. As such analysis requires extensive investigation, ACER is not in a position to fill this gap and perform such an analysis due to constraints on resources, time and expertise.

(113) In the absence of the analysis **referred to in Article 16(13) of the Electricity Regulation** which would determine the loop flow threshold and given the necessity for cost sharing methodology to apply a loop flow threshold, ACER explored an alternative and temporary solution to determine such threshold until the analysis by Core TSOs and its approval by Core regulatory authorities is completed.

(115) With regard to the common threshold for all Core bidding zones, ACER consulted Core TSOs for their expert opinion on what would be the total level of loop flows on bidding zone borders in the absence of structural congestion in any bidding zone. The responses from Core TSOs (which can also be found in Section 1.9 of the Non-paper of Core TSOs) varied. Some TSOs were explicitly supporting 3%, 5% or up to 10% of the maximum capacity of the cross-border relevant network element. Some other Core TSOs did not respond to this directly, but considered that this threshold should be higher than 10% and should at least reflect the assumptions regarding the loop flows made in capacity calculation **pursuant to Article 16(8) of the Electricity Regulation**. Despite the varied responses from Core TSOs, which should be understood as driven by their particular interest (i.e. TSOs of smaller zones create lower loop flows and prefer lower threshold, whereas TSOs from larger zones create larger loop flows and prefer larger threshold), ACER summarised these expert opinions into a compromise proposal that a common threshold for loop flows from all bidding zones would be defined per each cross-border relevant network element and would be equal to 10% of maximum capacity of such network element.

(118) Some Core TSOs and regulatory authorities from large bidding zones also argued that equal splitting of the common threshold among all bidding zones is discriminatory towards larger bidding zones and instead a proportional splitting should be applied. ACER rejected such a proposal, because a

proportional splitting of a threshold would make the concept of a loop flow threshold (as defined Article 16(13) of the Electricity Regulation) void, since the proportional splitting does not ensure that bidding zones which create very small loop flows and are considered as without structural congestion do not pay any costs. This is evident from the examples provided in Tables 1 and 2 below. In Table 1, equal splitting of the 10% common threshold to five bidding zones would result in an individual threshold equal to 2%. However, since bidding zone 1 does not use the whole individual threshold, the individual threshold can be increased by 2.33%, which results in exactly 10% of total sum of the loop flows below the individual threshold. In Table 1, the equal splitting of the common threshold ensures that bidding zones, which create small loop flows and are therefore considered as being without structural congestion, do not pay anything.

- (119) In Table 2, however, the proportional splitting of 10% common threshold, provides a much higher threshold for bidding zones with higher loop flows and much lower threshold for bidding zones with lower loop flows. This results into bidding zone shares which are exactly equal before and after application of the individual threshold. Such definition of individual threshold would therefore **contradict the intention of Article 16(13) of the Electricity Regulation**, which requires that bidding zones which do not have structural congestions and create low amount of loop flows do not pay any part of the costs of remedial action. In other words, proportional sharing of the common threshold would lead to make the smallest bidding zones without structural congestion still pay a portion of the costs of remedial actions, **which is against the intention of Article 16(13) of the Electricity Regulation**. It also makes the concept of a threshold void, since the shares before the application of a threshold and after application are completely the same.
- (121) ACER is of the view that this decision is a necessary and appropriate temporary solution until Core TSOs and regulatory authorities define and approve the level of a more appropriate loop flow threshold pursuant to Article 16(13) of the Electricity Regulation.

6.2.2.6. Priority of flow components

- (130) **In accordance with Article 16(13) of the Electricity Regulation**, the physical flows resulting from electricity exchanges (i.e. transactions) internal to bidding zones (i.e. internal flows and loop flows) should indeed be identified as the main contributors to the congestion and the TSOs of bidding zones in which those exchanges are settled should therefore bear the proportional part of the costs attributed to the congested network elements. In case of cross-zonal network elements these flows are loop flows, whereas in case of internal network elements, these flows are the internal flow and the loop flows, the former being caused by electricity exchanges within a bidding zone where such network element is located and the latter being caused by electricity exchanges within other bidding zones.
- (131) ACER recognises that **Article 16(13) of the Electricity Regulation does not make a specific distinction between loop flows and internal flows when referring to flows resulting from electricity exchanges (i.e. transactions) internal to bidding zones**. However, this Article requires regulatory authorities to analyse to what extent loop flows and internal flows contribute to congestion, but it does not prescribe the extent to which they contribute to congestion. **Article 16(13) of the Electricity Regulation therefore provides regulatory authorities the freedom to analyse and conclude to what extent the loop flows and internal flows contribute to congestion**. ACER considers that a conclusion by regulatory authorities that loop flows contribute to congestion more than internal flows is therefore **not contradicting Article 16(13) of the Electricity Regulation**.” (emphasis added)

1409. The Board of Appeal concludes that the Agency did not fail to adequately state reasons in its Contested Decision.

1410. **It follows that the Seventeenth Consolidated Plea must be dismissed as unfounded.**

Eighteenth Consolidated Plea – Duty of good administration.

1411. Appellant VI⁴³⁴ claims that ACER infringed Articles 6(11) and 14(6) ACER Regulation and Article 41 Charter by a failure to engage in adequate consultations with Core TSOs from September to November 2020 and in a failure to conduct a public consultation.

1412. Appellant V⁴³⁵ claims that ACER infringed the right to be heard, including Article 41 Charter and Article 14(6) ACER Regulation, when setting a legitimate LF threshold.

1413. The Defence⁴³⁶ responds that ACER complied with Article 6(11) and Article 14(6) ACER Regulation when consulting and hearing All Core TSOs and All Core NRAs, including on the determination of a legitimate LF threshold.

⁴³⁴ Appeal VI, Plea 8, paras 305-316.

⁴³⁵ Appeal V, Plea 3, paras 214-218.

⁴³⁶ Defence, paras 575-576 and 797-832

1414. Article 6(11) ACER Regulation states: *“When preparing its decision pursuant to paragraph 10, ACER shall consult the regulatory authorities and transmission system operators concerned and shall be informed of the proposals and observations of all the transmission system operators concerned.”*
1415. Article 14(6) ACER Regulation requires the Agency to inform any party concerned of its intention to adopt an individual decision prior to that adoption, and to afford those parties a chance to express their views on the matter: *“Before taking any individual decision as provided for in this Regulation, ACER shall inform any party concerned of its intention to adopt that decision, and shall set a time limit within which the party concerned may express its views on the matter, taking full account of the urgency, complexity and potential consequences of the matter.”*
1416. Article 41(a) Charter contains the fundamental right to be heard: *“Every person has the right to have his or her affairs handled impartially, fairly and within a reasonable time by the institutions, bodies, offices and agencies of the Union. 2. This right includes: (a) the right of every person to be heard, before any individual measure which would affect him or her adversely is taken;(..)”*
1417. In line with its earlier decision-making practice⁴³⁷, the Board of Appeal states that the Agency must comply with the fundamental rules of the TFEU and the general principles of EU law, and this includes the Charter and the principles of transparency and good administration contained in Article 15 of the TFEU. In its earlier decision-making practice, the Board of Appeal set out that the Charter codifies some of the fundamental rights governing EU procedural law, in particular Article 41 of the Charter establishing the right to good administration. The right to good administration requires that decisions be taken pursuant to procedures that guarantee fairness, impartiality and timeliness. In other words, good administration creates a duty of care to respect the right of every person to have his or her affairs handled impartially, fairly and within a reasonable time and obliges the administration to carefully establish and review all relevant factual and legal elements of a case taking into account not only the administration’s interests but also all other relevant interests, prior to making decisions or taking other steps⁴³⁸.
1418. The Charter’s procedural rights are not absolute rights. Their purpose is not to create abstract procedural obstacles, but to protect the rights of the addressees and other persons concerned by a decision, as provided for by the regulations applicable to such decision and by relevant case law⁴³⁹.

18.1 Consultation of Core TSOs from September to November 2020.

1419. Appellant VI alleges that, from September 2020, ACER failed to engage in adequate consultation with All Core TSOs, including Appellant VI.
1420. Appellant VI claims that, in general, after September 2020, ACER engaged in very limited discussions with All Core TSOs on cost-sharing.
1421. First, the Contested Decision evidences extensive consultations and a hearing with All Core TSOs and All Core NRAs since the beginning of the 6-month timeframe within which ACER is under a regulatory duty to adopt its decision (Articles 6(12) ACER Regulation and 9(11) CACM).
1422. Like all EU energy bottom-up decision-making processes, the RDCTCS decision-making process emphasized market initiative at the beginning of the process (i.e. a higher degree of involvement of TSOs, e.g. the initiation of the decision-making process by All Core TSOs’ RDCTCS Proposal), whereas the emphasis shifts towards regulatory compliance towards the end of the process (i.e. a higher degree of involvement of regulatory authorities, either NRAs

⁴³⁷ Board of Appeal Decisions A-002-2018, paras 101, 128 and 131; A-006-2109 paras 106-142; A-001-2018, paras 112-118; A-001-2020, paras 240, 252 and 263; A-002-2020, paras 241, 253 and 264; A-003-2020, paras 206 and 235; A-007-2020, paras 66 and 99 and A-008-2020, para 310.

⁴³⁸ See Opinion of AG van Gerven in Case C-16/90 Eugen Nölle EU:C:1991:402; and Case C-269/90 TU München EU:C:1991:438

⁴³⁹ Board of Appeal Decisions A-001-2017, para 124; A-001-2020, para 253; A-002-2020, para 254; A-007-2020, paras 67 and 101 and A-008-2020, paras 311 and 334.

or ACER). The Board of Appeal also observes that the bottom-up RDCTCS process had been on-going since 2018.

1423. Second, Appellant VI's appeal is a demonstration that All Core TSOs were invited in September and October 2020 to review and comment on ACER's amendments to the draft RDCTCS. It appears from the Defence that consultations with All Core TSOs lasted until 3 November 2020⁴⁴⁰.
1424. Appellant VI also claims it was given only 4 working days to review and comment on amendments to the draft RDCTCS that ACER had submitted to All Core TSOs on 9 September 2020⁴⁴¹ and that they communicated to ACER that this was insufficient in view of the nature of the amendments, which were substantial⁴⁴².
1425. First, Appellant VI duly provided its comments on 15 September 2020 in a joint document with other Core TSOs⁴⁴³. Second, the email correspondence has to be situated in the context of the RDCTCS bottom-up decision-making process, initiated in 2018. Third, ACER had to grant a deadline of 4 working days from 9 September until 15 September 2020 because ACER's Director had to submit its first RDCTCS proposal for approval by the BoR during their 93rd meeting of 16 September 2020, in order to ensure compliance with the 6-month deadline for ACER to take the RDCTCS decision, which ended on 27 September 2020. ACER's Director submitted a first draft RDCTCS Decision at the 93rd BoR' meeting⁴⁴⁴ but, after completion of the electronic voting procedure, the draft did not reach the 2/3rd majority and failed to be approved⁴⁴⁵. Fourth, the same deadline of 4 working days applied to all Core TSOs and Core NRAs addressees of the email correspondence referred to by Appellant VI. Fifth, the amendments were not unilateral amendments introduced by ACER but were the result of comments made by All Core NRAs and All Core TSOs during a hearing phase which lasted nearly a month: from 31 July 2020 until 20 August 2020 (on 6 August 2020, ACER granted an extension of the hearing phase from 14 August 2020 until 20 August 2020)⁴⁴⁶. During this hearing phase, dedicated meetings could be requested with ACER, either individually or with a group of Core TSOs or Core NRAs⁴⁴⁷. The Defence demonstrates, in this respect, that Appellant VI provided comments to the draft RDCTCS on 11 August 2020, which were duly taken into account by ACER⁴⁴⁸.
1426. As set out earlier, the lack of approval by the BoR has prevented ACER from adopting the Contested Decision within the prescribed deadline, i.e., by 27 September 2020. ACER thus continued consulting with the Core TSOs and the Core NRAs. Between 15 September 2020 and the request for final comments circulated by ACER on 23 October 2020, numerous other exchanges on the RDCTCS took place between ACER and Core TSOs RDCTCS, as set out in ACER's Defence:
- between 25 September 2020 and 28 September 2020: exchanges between the Italian TSO Terna and ACER (given that both the SEE RDCTCS of ACER Decision 31/2020 and the Core RDCTCS were developed in parallel, comments of SEE TSOs were shared with Core TSOs and *vice versa* in order to develop a consistent practice)⁴⁴⁹;

⁴⁴⁰ Confidential Annex 43 to the Defence, containing email correspondence between ACER and Elia on 3 November 2020. A non-confidential version of Annex 43 to the Defence has been provided by ACER and shared among parties.

⁴⁴¹ Annex A.2.2 to Appeal VI.

⁴⁴² Annex A.2.10 to Appeal VI.

⁴⁴³ Annexes 47 to the Defence, email correspondence sent by Core TSO Austrian Power Grid to ACER.

⁴⁴⁴ https://acer.europa.eu/Official_documents/BoR/Meeting_Docs/A20-BoR-93-02.pdf

⁴⁴⁵ Contested Decision, para 11.

⁴⁴⁶ Contested Decision, paras 26 and 27.

⁴⁴⁷ Annex 45 to the Defence, email chain from ACER to Core TSOs and Core NRAs.

⁴⁴⁸ Confidential Annexes 46 and 83 to the Defence, email correspondence between Appellant VI and ACER. A non-confidential version of Annexes 46 and 83 to the Defence has been provided by ACER and shared among parties.

⁴⁴⁹ Confidential Annex 50 to the Defence. A non-confidential version of Annex 50 to the Defence has been provided by ACER and shared among parties.

- on 28 September 2020, ACER circulated a presentation regarding the ROSC and RDCT, which included slides regarding the impact on cost sharing⁴⁵⁰;
- on 29 September 2020, Core TSOs circulated a presentation regarding the “*Definition of XRAs and relation to cost sharing*”⁴⁵¹;
- on 1 October 2020, the presentation of Core TSOs and input of certain individual TSOs was discussed during a call between ACER and Core NRAs⁴⁵²;
- on 7 October 2020, ACER sent an email to Core NRAs and Core TSOs informing that some of the amendments proposed by TSOs during the consultation on the ROSC would be included in the RDCTCS as ACER strived to ensure consistency between the ROSC, RDCT and RDCTCS⁴⁵³;
- on 20 October 2020, ACER held a conference call with Core NRAs and Core TSOs during which the Italian NRA ARERA and an Italian TSO TERNA presented comments on the RDCTCS amendments⁴⁵⁴;
- on 20 October 2020, ACER sent an updated RDCTCS version, which included amendments following conference calls with Core NRAs and Core TSOs. Core NRAs and Core TSOs were requested to consider these versions for commenting, but no deadline was imposed⁴⁵⁵. This triggered various comments by Core TSOs: the Belgian TSO Elia together with Intervener CREG (Belgian NRA)⁴⁵⁶, the Slovenian TSO ELES⁴⁵⁷, the Austrian TSO Austrian Power Grid⁴⁵⁸, the German TSO TenneT (Appellant V) which merged the comments of several Core TSOs⁴⁵⁹, the Dutch TSO TenneT (Appellant V) individually⁴⁶⁰, Appellant I⁴⁶¹ and Intervener MAVIR (Hungarian TSO)⁴⁶².

1427. In the same line, Appellant VI claims that it was given insufficient time to review and provide final comments on the amendments to the draft RDCTCS that ACER had submitted to All Core TSOs on 23 October 2020⁴⁶³, because ACER provided it at 12:56 pm and requested Appellant VI to provide comments by 16:00 pm.

1428. First, Appellant VI duly provided its comments on 23 October 2020 within the set deadline⁴⁶⁴. A short deadline was set for all addressees of the email, not only for Core TSOs but also for Core NRAs and TSOs and NRAs from other regions (“*Core/CH/IN SEE TSOs and NRAs*”). Second, this email has to be set in context, whereby ACER was already exceeding the regulatory deadline of 6 months to adopt the Contested Decision by a month (it had expired on 27 September 2020). In order to minimise the delay, ACER’s Director submitted a new draft RDCTCS for the state of play discussion by the BoR during their 94th meeting of 13

⁴⁵⁰ Annex 51 to the Defence.

⁴⁵¹ Annex 52 to the Defence.

⁴⁵² Confidential Annex 53 to the Defence. A non-confidential version of Annex 53 to the Defence has been provided by ACER and shared among parties.

⁴⁵³ Annex 54 to the Defence.

⁴⁵⁴ Annex 55 to the Defence.

⁴⁵⁵ Annex 56 to the Defence.

⁴⁵⁶ Confidential Annex 57 to the Defence. A non-confidential version of Annex 57 to the Defence has been provided by ACER and shared among parties.

⁴⁵⁷ Annex 58 to the Defence.

⁴⁵⁸ Annexes 59 and 60 to the Defence and confidential Annex 61 to the Defence. A non-confidential version of Annex 61 to the Defence has been provided by ACER and shared among parties.

⁴⁵⁹ Annex 62 to the Defence.

⁴⁶⁰ Confidential of Annex 63 to the Defence. A non-confidential version of Annex 63 to the Defence has been provided by ACER and shared among parties.

⁴⁶¹ Annex 64 to the Defence.

⁴⁶² Confidential annex 65 to the Defence. A non-confidential version of Annex 65 to the Defence has been provided by ACER and shared among parties.

⁴⁶³ Annex A.2.8 to Appeal VI.

⁴⁶⁴ Annex 68 to the Defence. See also, Confidential Annex 84 to the Defence. A non-confidential version of Annex 84 to the Defence has been provided by ACER and shared among parties.

October 2020⁴⁶⁵. In the email of 23 October 2020, addressees, including Core TSOs, were merely requested to provide their final comments on the updated RDCTCS version, compared to the RDCTCS that had been submitted to them in preparation of the 94th meeting of the BoR: “Please find enclosed the updated RDCT cost sharing methodology compared to the update version sent on 13 October. Please cross-check the changes made today. Any last remark can be sent to us by today 16h. All changes applied in Core RDCT cost sharing methodology will be applied also to SEE RDCT cost sharing methodology.”⁴⁶⁶ This updated RDCTCS version took account of several comments provided by Core NRAs and Core TSOs on the version circulated on 20 October 2020⁴⁶⁷. During the 95th BoR meeting of 18 November 2020⁴⁶⁸, ACER’s Director presented a new draft RDCTCS Decision. Given that the proposed comments did not reach the required majority for their adoption at the 95th meeting of the BoR, members were subsequently invited to vote on the new draft RDCTCS Decision: 27 members participated and 2/3rd of the members present or represented of the BoR granted a favourable opinion to the new draft RDCTCS Decision.

1429. The Board of Appeal refers to its earlier decision-making practice⁴⁶⁹ and observes that deadlines for comments are set to avoid deadlock situations and ensure that ACER complies with its regulatory obligation to adopt individual decisions in accordance with Article 16(12) ACER Regulation in a timeframe of 6 months. In October 2020, ACER was under a regulatory obligation to set tight deadlines due to the fact that it had already exceeded the 6 month deadline to adopt the Contested Decision, which had expired on 27 September 2020.

1430. In this context, Appellant VI’s claim that one day was insufficient, especially when comparing with the three days that All Core TSOs were granted to review and provide final comments on the amendments to the draft ROSC⁴⁷⁰, is flawed. First, the ROSC relates to a separate decision-making process leading-up to ACER Decision 33/2020, taken on 4 December 2020. Second, ACER Decision 33/2020 was not adopted after the expiry of the 6 month deadline provided by Article 16(12) ACER Regulation and did not trigger a similar debate on the ROSC scope as the Contested Decision with respect to the RDCTCS scope.

18.2 Transfer of decision-making to ACER from NRAs should have triggered a separate public consultation.

1431. Appellant VI claims that the transfer of decision-making from All Core NRAs to ACER should have triggered a separate public consultation.

1432. First, there is no legal obligation on ACER to hold a public consultation.

1433. Article 14(6) ACER Regulation only contains a “*duty to inform parties concerned*” and to let them “*express their views*” within a certain deadline, “*taking account of the urgency, the complexity and the potential consequences*”. It does not contain a duty to hold a public consultation.

1434. According to Article 6(11) ACER Regulation, when preparing its decision pursuant to Article 6(10) ACER Regulation, ACER “*shall consult the regulatory authorities and transmission system operators concerned and shall be informed of the proposals and observations of all the transmission system operators concerned*”.

1435. The requirement is to consult with NRAs and TSOs but not to hold a public consultation.

1436. The Board of Appeal has confirmed this duty in its earlier decision-making⁴⁷¹.

1437. In addition, Article 74 CACM does not contain an obligation for ACER to hold a public consultation either.

⁴⁶⁵ https://acer.europa.eu/Official_documents/BoR/Meeting_Docs/A20-BoR-94-02.pdf

⁴⁶⁶ Annex A.2.8 to Appeal VI.

⁴⁶⁷ Annex 56 to the Defence.

⁴⁶⁸ https://acer.europa.eu/Official_documents/BoR/Meeting_Docs/A20-BoR-95-02.pdf

⁴⁶⁹ Board of Appeal Decision A-004-2019, para 188.

⁴⁷⁰ Annex A.2.11 to Appeal VI.

⁴⁷¹ Board of Appeal Decisions A-007-2020, para 98; and A-008-2020, paras 312-330.

1438. Second, even though it is correct that ACER carried out a public consultation prior to taking ACER Decision 33/2020 (ROSC) and 35/2020 (RDCT), it was under no legal obligation to do so as long as it complied with its above-mentioned obligations under Articles 6(11) and 14(6) of ACER Regulation. The public consultation held for the ROSC and the RDCT explicitly states that it was carried out to enable ACER “*to take an informed decision*”⁴⁷².
1439. Third, Appellant VI did not provide any comment to the public consultation on ROSC and RDCT, notwithstanding the fact that their scope is identical to the scope of the RDCTCS and that Appellant VI challenges the RDCTCS scope in the present appeal.
1440. Fourth, in the absence of a legal obligation to carry out a public consultation, ACER’s choice not to hold a public consultation but, instead, to extensively consult with the NRAs and TSOs, was in line with its obligations under Articles 6(11) and 14(6) of ACER Regulation. The Contested Decision sets out that ACER extensively consulted with the NRAs and TSOs, as demonstrated by paragraph 11 of the Contested Decision, quoted above in the Seventeenth Consolidated Plea. In so doing, it consulted the AEWG. Paragraphs (24) and (25) of the Contested Decision state, in this respect:
- “(24) *During the close cooperation phase between ACER and all Core regulatory authorities and TSOs as detailed in paragraph (11) above, and beyond the above-mentioned issues, ACER: (a) discussed the eligibility of cross-border relevant network elements (XNEs) for cost sharing based on the CACM Regulation and the Electricity Regulation; (b) clarified the details of applied flow decomposition methodology, including the definition of flow components; (c) discussed the methodological aspects of cost sharing, including netting, application of loop flow threshold and prioritisation of flows; (d) discussed possible solutions on mapping of costs to cross-border relevant network elements (XNEs), by exploring different options, including the improved volume based mapping, which was tested by TSOs, and proposed several other options for consideration to TSOs and regulatory authorities; (e) provided simulation results for all the choices and options which were discussed during consultation to allow the TSOs and regulatory authorities to consider the concrete impact of these choices and options; and (f) discussed all other relevant topics related to data provision to regulatory authorities, transparency, monitoring and implementation of cost sharing methodology.*
- (25) During the consultation process, Core TSOs provided to ACER also the ‘Non-paper of all Core transmission system operators on the Core CCR TSOs’ regional proposals of re-dispatching and countertrading coordination and cost sharing methodologies’ (hereinafter referred to as ‘Non-paper of Core TSOs’). In this document, Core TSOs expressed their individual positions on the numerous choices and points of disagreements among Core TSOs.”*
1441. These extensive consultations with All Core TSOs and All Core NRAs are evidenced throughout the Contested Decision:
- paragraph 101: “*(..) ACER carefully analysed both methods and consulted also with TSOs and regulatory authorities, which supported the full line decomposition method (..)*”.
- paragraph 111: “*During its proceedings on this Decision, ACER invited Core TSOs to submit such an analysis to ACER before the expiry of the consultation deadline, i.e. by 20 August 2020; however, Core TSOs did not do so.*”
- paragraph 115: “*With regard to the common threshold for all Core bidding zones, ACER consulted Core TSOs for their expert opinion on what would be the total level of loop flows on bidding zone borders in the absence of structural congestion in any bidding zone. (..)*”
- paragraph 120: “*Based on the above consideration and consultation of the Core TSOs and regulatory authorities, ACER decided (..)*”
- paragraph 144: “*ACER consulted this issue with TSOs and regulatory authorities of Germany and Luxembourg, which currently constitute the only bidding zone where several TSOs are involved.*”
- paragraph 146: “*However, after consulting with Core TSOs and regulatory authorities, ACER understands that these requirements cannot be met (..)*”
- paragraph 156: “*After consultation with Core TSOs and regulatory authorities, ACER was informed (..)*”
1442. ACER also held an extensive hearing phase from 31 July 2020 until 20 August 2020 with All Core NRAs and All Core TSOs, with an in-depth analysis of the issue challenged by the present appeal, as set out by paragraphs 26 to 29 of the Contested Decision:

⁴⁷² https://acer.europa.eu/Official_documents/Acts_of_the_Agency/Individual%20decisions%20Annexes/ACER%20Decision%20No%2035-2020_Annexes/ACER%20Decision%2035-2020%20on%20Core%20RDCT%2035%20-%20Annex%20II.pdf

- “(26) ACER initiated a hearing phase on 31 July 2020 by providing all Core TSOs and regulatory authorities with the draft amendments to the Proposal representing the draft of the adopted cost sharing methodology for the Core CCR. The end of the hearing period was announced as 14 August 2020.
- (27) On 6 August 2020, ACER provided to all Core TSOs and regulatory authorities an updated proposal of the draft amendments to the Proposal with additional details related to mapping solution. Due to this updated proposal, the end of hearing period was extended until 20 August 2020.
- (28) During the hearing, the Core TSOs and regulatory authorities provided their individual comments and concerns regarding the cost sharing methodology proposed by ACER. Some Core TSOs and regulatory authorities also requested a meeting and ACER accepted this request and organised dedicated teleconferences during the hearing period. The main concerns expressed by the Core TSOs and regulatory authorities during the hearing were:
- (a) Regarding the eligibility of cross-border relevant network elements for cost sharing, some TSOs and regulatory authorities alleged that Article 16(13) of the Electricity Regulation requires only network elements located on bidding zone borders to be subject to the cost sharing.
 - (b) Regarding the mapping solution, some Core TSOs and regulatory authorities expressed the concern that the least-cost based mapping method proposed by ACER would require an additional assessment and experience.
 - (c) Regarding the flow decomposition, some TSOs and regulatory authorities disagreed with the selection of the power flow colouring (‘PFC’) method and the related principles, such as treatment of high voltage direct current (‘HVDC’) flows.
 - (d) Regarding the calculation of allocated flows, loop flows and internal flows in the flow decomposition, several TSOs and NRAs expressed concerns that the generation shift key used in capacity calculation is not appropriate for calculating allocated flows, loop flows and internal flows for bidding zones that import electricity.
 - (e) Regarding the netting solution, some Core TSOs and regulatory authorities opposed the solution of not applying the netting of relieving and burdening flows.
 - (f) Regarding the threshold application, some Core TSOs and regulatory authorities commented that a common loop flow threshold of 10% is not the result of a study or expert-based opinion.
 - (g) Regarding the prioritisation of flows, some Core TSOs and regulatory authorities opposed the proposal that loop flows are the first priority and internal flows are the second priority when identifying contributors to congestion. They considered this to be a discrimination towards the TSOs creating large loop flows.
 - (h) Regarding the socialisation of congestion costs arising from flows originating outside the Core CCR, some TSOs and regulatory authorities commented that the loop flows from outside the Core CCR should be treated equally as the loop flows within the Core CCR.
- (29) In the adopted cost sharing methodology, ACER integrated all plausible comments and proposals and provided additional examples of specific calculation principles. After the end of the hearing period, ACER also provided the Core TSOs and regulatory authorities with the responses to all the received comments as well as how they were taken into account and why.”

1443. Fifth, All Core TSOs, including Appellant VI, did not publicly consult on their RDCTCS Proposal prior to its submission on 27 March 2019, as expressly stated in paragraph 6 of the Contested Decision.
1444. Appellant VI’s claim relating to Recital 10(d) of the Contested Decision’s RDCTCS fails to acknowledge the relevance of the word “direct” in said Recital. As set out in the Sixteenth Consolidated Plea, Recital 10(d) stipulates that the Contested Decision does not directly concern any other market participants. This is expressly set out in Recital (10)(d) of the Contested Decision’s RDCTCS: “(..) On the other hand, this methodology is deemed to have no direct effect on NEMOs, regulatory authorities, ACER and market participants”. However, the Contested Decision indirectly affects other market participants.
1445. Furthermore, the Board of Appeal observes that the preliminary stages of the decision-making process had been lengthy and had already given rise to an extensive dialogue, of which ACER was able to take stock. Accordingly, ACER took due account of All Core TSOs’ RDCTCS Explanatory Document, Experimentation Report and Non-Paper and of All Core NRAs’ Non-Paper, whilst acknowledging their disclaimers and caveats.
1446. On Appellant VI’s assumption that “ACER’s position was motivated by unfounded policy goals to limit the range of stakeholder views to be addressed in its final decision”, the Board of Appeal notes that, as has been demonstrated throughout this decision, the Contested Decision consisted of ACER’s regulatory supervision of the RDCTCS in order to ensure

compliance with the applicable regulatory framework. It did not act on the basis of policy goals.

18.3 The threshold for acceptable LFs infringes the right to be heard.

1447. Appellant V alleges that ACER consulted with All Core TSOs for their expert opinion on a legitimate LF threshold but did not duly take account of their responses because it considered that they merely reflected individual interests, as evidenced in paragraph 115 of the Contested Decision. Regardless of the correctness of the assertion, ACER should, in its view, have given an opportunity to All Core TSOs to provide clarifications on this assertion prior to adopting the Contested Decision. The Contested Decision might, in its view, have been different if All Core TSOs had been able to demonstrate that their views were not solely based on interests relating to their own BZ, but based on other grounds, e.g. a different network topology, network situation or geographical distance.
1448. Paragraph 115 of the Contested Decision reads as follows: *“With regard to the common threshold for all Core bidding zones, ACER consulted Core TSOs for their expert opinion on what would be the total level of loop flows on bidding zone borders in the absence of structural congestion in any bidding zone. The responses from Core TSOs (which can also be found in Section 1.9 of the Non-paper of Core TSOs) varied. Some TSOs were explicitly supporting 3%, 5% or up to 10% of the maximum capacity of the cross-border relevant network element. Some other Core TSOs did not respond to this directly, but considered that this threshold should be higher than 10% and should at least reflect the assumptions regarding the loop flows made in capacity calculation pursuant to Article 16(8) of the Electricity Regulation. Despite the varied responses from Core TSOs, which should be understood as driven by their particular interest (i.e. TSOs of smaller zones create lower loop flows and prefer lower threshold, whereas TSOs from larger zones create larger loop flows and prefer larger threshold), ACER summarised these expert opinions into a compromise proposal that a common threshold for loop flows from all bidding zones would be defined per each cross-border relevant network element and would be equal to 10% of maximum capacity of such network element.”*
1449. The Board of Appeal refers to Sub-pleas 17.1 and 17.2 above, which demonstrate that ACER conducted an extensive consultation on the RDCTCS, including on the issue of a legitimate LF threshold.
1450. Paragraph 115 of the Contested Decision has to be placed in the context, set out in detail in the Seventh Consolidated Plea above, whereby ACER was obliged to determine a temporary threshold for legitimate LFs in order to ensure compliance with Article 16(13)ER because Core TSOs had not been able to reach an agreement on the issue, even pursuant to ACER’s invitation to do so by the end of the hearing stage on 20 August 2020. In the absence of an agreement by All Core TSOs on a legitimate LF threshold, ACER had to determine a temporary LF threshold to ensure compliance with the ER. Indeed, ACER’s Director had to submit its draft RDCTCS Decision for approval during the BoR’ 93rd meeting of 16 September 2020, if it wanted to adopt the Contested Decision within the regulatory 6 month timeframe, expiring on 27 September 2020.
1451. To this end, ACER determined a temporary legitimate LF threshold for each BZ in 2 steps: (1) the definition of a common threshold for each XNE regarding the total level of LFs arising from all Core BZs; and (2) the division of the common threshold between BZs to establish an individual threshold that determines the maximum level of LFs from each individual BZ that should not be penalised in cost sharing. This is expressly set out in paragraphs 114 and 115 of the Contested Decision.
1452. For step (1), ACER consulted All Core TSOs on what the total level of LFs would be on BZBs in the absence of structural congestions in any BZ. The comments of Core TSOs on ACER’s proposed 10%-threshold demonstrated divergent opinions on the issue. It was followed by numerous exchanges on the issue between ACER, Core TSOs and Core NRAs through email correspondence and conference calls⁴⁷³. ACER ascertained that a temporary common threshold of 10% would be accepted as a compromise by a majority of Core TSOs,

⁴⁷³ Annexes 44, 47, 71, 73 and 75 to the Defence and Confidential Annexes 72, 74 and 88 to the Defence. A non-confidential version of Annexes 72, 74 and 88 to the Defence has been provided by ACER and shared among parties.

based on several rounds of observations⁴⁷⁴. This is expressly set out in paragraph 116 of the Contested Decision and contradicts Appellant V's claim that ACER did not sufficiently consult on the legitimate LF threshold.

1453. For step (2), ACER decided to split the common threshold and determine individual LF thresholds per BZ on the basis of a specific splitting process, after having carefully analysed the possibility of an alternative splitting process, put forward by some Core TSOs and NRAs. This analysis of the equal splitting process versus the proportional splitting process is expressly set out in paragraphs 118 to 120 of the Contested Decision. It demonstrates that ACER carefully analysed the alternative process but came to a conclusion that this alternative splitting process did not comply with the applicable regulatory requirements.
1454. Furthermore, as set out in the Fourteenth Consolidated Plea, a legitimate LF threshold was indispensable for the Contested Decision's RDCTCS. This was acknowledged by All Core TSOs in Article 8 of their RDCTCS Proposal. In the absence of ACER's determination of a temporary threshold for legitimate LFs, a deadlock situation could have occurred whereby the inability for All Core TSOs to reach an agreement could have led to the consequence that no adequate RDCTCS could have been implemented.
1455. As to Appellant V's allegation that the Contested Decision might, in its view, have been different if All Core TSOs had been able to demonstrate that their views were not solely based on interests relating to their own BZ, but based on other grounds, the Board of Appeal notes that the implementation of the interim solution could still be avoided by All Core TSOs, including Appellant V, as soon as they would agree on a definitive legitimate LF threshold to replace ACER's temporary threshold. All Core TSOs' could even agree to determine a legitimate LF threshold before the implementation of the RDCTCS in order to avoid any use of ACER's temporary threshold at all. Furthermore, Appellant V fails to demonstrate how the possibility of another round of comments by All Core TSOs would have ensured a common agreement between All Core TSOs on a legitimate LF threshold. It would, at most, have triggered additional observations on the reasons for the varied responses of All Core TSOs, which would have reinforced the need for ACER to determine a temporary common legitimate LF threshold. The Board of Appeal notes, in this respect, that no steps have been taken by Core TSOs to determine a legitimate LF threshold since the adoption of the Contested Decision⁴⁷⁵.
1456. **It follows that the Eighteenth Consolidated Plea must be dismissed as unfounded.**

Nineteenth Consolidated Plea – Review of RDCTCS.

1457. Appellant IV⁴⁷⁶ claims that Article 12(2) of the Contested Decision's RDCTCS infringes Article 76(4)(b) CACM in conjunction with Article 9(13) CACM because it obliges Core TSOs to propose an amendment to the RDCTCS. This, in its view, is incoherent with the responsibilities of TSOs, who are the stakeholders that determine whether and when to trigger the amendment procedure. In its view, Article 9(13) CACM determines that only the TSOs responsible for developing a proposal for methodologies and the regulatory authorities responsible for their adoption in accordance with Article 9(6), (7) and (8) CACM may request amendments to these methodologies and that Article 9(13) CACM does not confer the same rights to ACER.
1458. Appellant IV also challenges paragraph 154 of the Contested Decision, which states: "*Based on request from Core TSOs and regulatory authorities, ACER also added the obligation for a general review of the methodology twelve months after its implementation. This will allow the TSOs to gain sufficient understanding and information about the appropriateness of all the aspects of the cost sharing solution based on real data. The review should be followed by the development of a proposal for an amendment of the cost sharing methodology submitted to Core regulatory authorities for approval.*" Appellant IV considers that ACER could have

⁴⁷⁴ Annex 66 to the Defence.

⁴⁷⁵ Replies to the Third Request for Information of the Board of Appeal of Appellants I, III, IV, V and VI.

⁴⁷⁶ Appeal IV, Plea 6, paras 190-195.

gained sufficient understanding and information about the appropriateness of all the aspects of the RDCTCS based on real data by merely inviting All Core TSOs to analyse and address the issue, without imposing an obligation to amend the RDCTCS.

1459. The Defence⁴⁷⁷ responds that Article 14 of All Core TSOs' RDCTCS Proposal provided a similar obligation as Article 12(2) of the Contested Decision's RDCTCS (as confirmed by the Explanatory Document to All Core TSOs' RDCTCS Proposal) and that ACER slightly modified the proposed obligation to amend the RDCTCS by linking the requirement to submit an amendment to the annual review to be performed by TSOs, mainly to ensure compliance with Article 74(6)(b) CACM.
1460. Article 74(6)(b) CACM requires the RDCTCS to *"be consistent with the responsibilities and liabilities of the TSOs involved (...)".*
1461. Article 9(13) CACM states that *"TSOs or NEMOs responsible for developing a proposal for terms and conditions or methodologies or regulatory authorities responsible for their adoption in accordance with paragraphs 6, 7 and 8, may request amendments of these terms and conditions or methodologies. The proposals for amendment to the terms and conditions or methodologies shall be submitted to consultation in accordance with the procedure set out in Article 12 and approved in accordance with the procedure set out in this Article."*
1462. Article 12(2) of the Contested Decision's RDCTCS reads as follows: *"No later than twelve months after the implementation of this cost sharing methodology, all Core TSOs shall develop a proposal for amendment of this methodology, which shall aim to improve all the aspects of this cost sharing methodology. By the same deadline, the proposal for amendment shall be submitted for approval to Core regulatory authorities."*
1463. As set out above in the Fourteenth Consolidated Plea, neither did ACER take the Contested Decision on the basis of Article 9(13) CACM, nor did it usurp All Core TSOs' and All Core NRAs' competences to table amendments under Article 9(13) CACM when including an obligation on All Core TSOs in Article 12(2) of the Contested Decision's RDCTCS to table an amendment within 12 months.
1464. ACER took the Contested Decision on the basis of Article 6(10) ACER Regulation, requiring it to carry out the regulatory supervision of All TSOs' RDCTCS Proposal under the applicable regulatory framework, in particular Article 74 CACM. When introducing an obligation for All Core TSOs to amend the RDCTCS within 12 months, ACER reproduced Article 14 of All Core TSOs' RDCTCS Proposal. In addition, in order to ensure compliance with Article 74 CACM, ACER linked the annual review of the RDCTCS – which All Core TSOs had proposed in Article 13 of their RDCTCS Proposal – to the obligation on All Core TSOs to table an amendment – which All Core TSOs had proposed in Article 14 of their RDCTCS Proposal – .
1465. Article 13 of All Core TSOs' RDCTCS Proposal contained an annual review process of the RDCTCS in order to identify possible improvements regarding the effectiveness of applied RAs and the appropriateness, fairness and effectiveness of cost sharing. Article 14 of All Core TSOs' Proposal contained (i) an obligation to publish the RDCTCS; (ii) an obligation to amend the RDCTCS during the year following its approval or as soon as the details requiring clarification would be available (*"This Cost Sharing Methodology shall be amended by Core TSOs no later than 12 months after its approval, or as soon as the details that require clarification are available, whichever happens earlier"*) and (iii) a statement that the RDCTCS' implementation was conditional upon regulatory approval of the RDCTCS (Article 9 CACM), of the RDCT (Article 35(1) CACM), of the CCM (Articles 20 and 21 CACM), of the CSAM (Article 75(1) SO), of the ROSC (Article 76(1) SO) and of the development, testing and implementation of IT tools, systems and procedures required to support the RDCTCS:
- "Article 14 Implementation*
- 1. Core TSOs shall publish this Cost Sharing Methodology without undue delay after its approval in accordance with article 9(10), articles 9(11) or 9(12) of the CACM guideline.*
 - 2. This Cost Sharing Methodology shall be amended by Core TSOs no later than 12 months after its approval, or as soon as the details that require clarification are available, whichever happens earlier. This amendment shall also contain a detailed time plan for implementation in accordance with Article 9(13) of the CACM guideline.*

⁴⁷⁷ Defence, paras 781-796.

3. The implementation of the Cost Sharing Methodology is subject to: a. Regulatory approval of this Cost Sharing Methodology in accordance with Article 9 of CACM guideline; b. Regulatory approval of the Core RD and CT Methodology pursuant to Article 35(1) of CACM guideline in accordance with Article 9 of CACM guideline; c. Regulatory approval of common coordinated capacity calculation methodology required by Articles 20 and 21 of CACM guideline in accordance with Article 9 of CACM guideline; d. Regulatory approval of the coordinated security analysis methodology pursuant to Article 75(1) of SO guideline, its implementation, the regulatory approval of the methodology for regional operational security coordination pursuant to Article 76(1) of SO guideline and its implementation; e. Development, testing and implementation of the IT tools, systems and procedures required to support the Cost Sharing Methodology”

1466. The Explanatory Document to All Core TSOs’ RDCTCS Proposal⁴⁷⁸ states in the same line: “In article 14 of the submitted methodology, Core TSOs commit themselves to submit an amended version of this methodology, no later than 12 months after its approval or after an agreement is reached on the details of the cost sharing application (whichever happens earlier).”
1467. That is precisely why ACER introduced an obligation upon All Core TSOs to amend the RDCTCS within 12 months of its adoption.
1468. Furthermore, ACER correctly linked the annual review of the RDCTCS to the obligation to table an amendment given that this ensures compliance with Article 74 CACM, *inter alia*, due monitoring and improvement (Article 74(5) CACM), consistency with the responsibilities and liabilities of Core TSOs (Article 74(6)(b) CACM), facilitating the efficient long-term development and operation of the pan-European interconnected system and the efficient operation of the pan-European electricity market (Article 74(6)(e) CACM) and facilitating adherence to the general principles of CM as set out in Article 16 ER (Article 74(6)(f) CACM), including Article 16(13) ER, which mandates All Core TSOs to determine a legitimate LF threshold to replace the temporary threshold set by Article 7(5) of the Contested Decision’s RDCTCS. Linking the annual review to the obligation to table an amendment in order to ensure an implementation of identified improvements is important to ensure that the RDCTCS meets the CACM and ER objectives, especially when considering the earlier delays that had arisen due to Core TSOs’ inability to agree (All Core TSOs were unable to submit their proposal by the deadline of 17 May 2018 and submitted it almost a year later than the regulatory required date⁴⁷⁹). The Contested Decision fits within the objectives of the CACM and ER, *inter alia* the objective Article 3(g) CACM of “contributing to the efficient long-term operation and development of the electricity transmission system and electricity sector in the Union”.
1469. Contrary to what Appellant IV claims, the obligation upon All Core TSOs’ to table an amendment within 12 months does not infringe the requirement of consistency with TSOs’ responsibilities and liabilities under Article 74(6)(b) CACM, but ensures compliance with said requirement.
1470. Appellant IV ties this plea to the issue of mapping, i.e. splitting of total costs to individual XNEs, addressed by Section 6.2.2.2 of the Contested Decision, more specifically paragraph 91 of the Contested Decision, which states: “Some Core TSOs and regulatory authorities also expressed concerns that the final mapping solution can only be adopted once more testing on real data is performed. To address this concern, ACER introduced in Article 12 of the adopted cost sharing methodology a general obligation to review all aspects of the methodology and propose amendments where required 12 months after the implementation of the cost sharing methodology. With this regard, some TSOs and regulatory authorities pointed out the need that the mapping solution should be improved to take into account the specific effects of remedial action optimisation where congestions on network elements are not resolved directly, but rather redirected to other network elements where they can be resolved with cheaper remedial actions. The proposed current mapping solution fails to properly take into account such shifting of congestions. As it was not possible to adequately and robustly address this problem during the adoption of this cost sharing methodology, ACER invites TSOs to analyse it during and after implementation and to propose amendments to address this problem to the degree possible.” Appellant IV claims that, if the purpose of ACER was to invite Core TSOs to address the concerns expressed by some Core TSOs and NRAs about it not being possible to adopt the final mapping solution before more testing on real data had been

⁴⁷⁸ Annex 13 to the Defence, p. 55.

⁴⁷⁹ Contested Decision, para 6.

performed, ACER should have invited All Core TSOs to analyse and address the problem. However, in its view, there is no legal basis and no need for ACER to stipulate an obligation on TSOs in this regard.

1471. The Board of Appeal considers that the introduction of a general obligation upon All Core TSOs to review all aspects of the RDCTCS and propose amendments, where required, within 12 months, ensures compliance with the applicable regulatory framework, as set out above, especially on an issue such as mapping, where paragraphs 82 to 91 of the Contested Decision set out that 5 different mapping solutions had been analysed, that some of them had been tested with real data and that there was a possibility that the mapping solution retained by the RDCTCS failed to properly take account of the shifting of congestions, but that the issue could not be adequately reviewed prior to the adoption of the Contested Decision. ACER was under an obligation, when carrying out its duties of regulatory supervision of All Core TSOs' RDCTCS Proposal, to ensure the achievement of the CACM objectives, *inter alia*, “ensuring optimal use of the transmission infrastructure” (Article 3(b) CACM), “ensuring operational security” (Article 3(c) CACM) and “contributing to the efficient long-term operation and development of the electricity transmission system and electricity sector in the Union” (Article 3(g) CACM).

1472. **It follows that the Nineteenth Consolidated Plea must be dismissed as unfounded.**

DECISION

On those grounds,

THE BOARD OF APPEAL

Hereby confirms the Contested Decision and dismisses the Appeals for annulment.

This decision may be challenged pursuant to Article 263 of the Treaty on the Functioning of the European Union and Article 29 of Regulation (EU) 2019/942 within two months of its publication on the Agency website or of its notification to the Appellant as the case may be.

SIGNED

SIGNED



Andris Piebalgs
Chairperson of the Board of Appeal

SIGNED

SIGNED



Ronja Linßen
Acting Registrar of the Board of Appeal

ANNEX – LIST OF ABBREVIATIONS

Acronym	Definition
AC	Alternating Current
ACER	European Union Agency for the Cooperation of Energy Regulators Regulation (EU) 2019/942 of the European Parliament and of the Council of 5 June 2019 establishing a European Union Agency for the Cooperation of Energy Regulators
ACM	Dutch NRA
AEWG	ACER Electricity Working Group
AF	Allocated Flows
AP	Action Plan
APG	Austrian Power Grid
ARERA	Italian NRA
BZ	Bidding Zone
BZB	Bidding Zone Border
CA	Capacity Allocation
CACM	Commission Regulation (EU) 2015/1222 of 24 July 2015 establishing a guideline on capacity allocation and congestion management
CB	Cross Border
CC	Capacity Calculation
CCC	Coordinated Capacity Calculator
CCM	Capacity Calculation Methodology
CCR	Capacity Calculation Region
CEPS	Czech TSO
CGM	Common Grid Model
CGMM	Common Grid Model Methodology
CIDM	Congestion Income Distribution Methodology
CJEU	Court of Justice of the European Union
CM	Congestion Management
CMF	Capacity Management Function
CNE	Critical Network Element
CNEC	Critical Network Element associated with Contingency
CRE	French NRA
CREG	Belgian NRA
CREOS	Luxembourg TSO
CROSA	Coordinated Regional Operational Security Assessment
CSA	Coordinating Operational Security Analysis
CSAM	Coordinating Operational Security Analysis Methodology
CT	Counter-Trading
CWE	Central and Western European region
CZ	Cross Zonal
CZC	Cross Zonal Capacity
D2CF	Two-Days-Ahead Congestion Forecast
DA	Day Ahead
DACF	Day Ahead Congestion Forecast
DSO	Distribution System Operator
EBGL	Electricity Balancing Guidelines
EC	European Commission
ELES	Slovenian TSO

ELIA	Belgian TSO
ENEL	Italian TSO
ENTSO	European Network of Transmission Operators for Electricity
EPO	European Patent Office
ER	Regulation (EU) 2019/943 of the European Parliament and of the Council of 5 June 2019 on the internal market for electricity
Electricity Directive	Directive (EU) 2019/944 of the European Parliament and of the Council of 5 June 2019 on common rules for the internal market for electricity and amending Directive 2012/27/EU
ERO	Energy Regulatory Office
ESMA	European Securities and Markets Authority
EU	European Union
FCA	Forward Capacity Allocation
FLC	Full Load Current
FLD	Full Line Decomposition method
FRM	Flow Reliability Margin
GCEU	General Court of the European Union
GLSK	Generation and Load Shift Key
GSK	Generation Shift Key
HEA	Hungarian NRA
HOPS	Hungarian TSO
HV	High Voltage
HVDC	High Voltage Direct Current
ID	Intra Day
IDCF	Intra Day Capacity Forecast
IF	Internal Flow
IGM	Individual Grid Model
INIF	Imbalance Netting Implementation Framework
INPF	Imbalance Netting Process Function
ISP	Integrated Scheduling Process
IT	Information Technology
ITC	Inter-TSO compensation mechanism
LCBM	Least Cost Based Mapping
LEN	Legal Expert Network
LF	Loop Flow
LSK	Load Shift Key
LTA	Long Term Allocation
MAVIR	Hungarian TSO
MFLD	Multi-stage Full Line Decomposition Method
MRA	Multilateral Remedial Action agreement
MTU	Market Time Unit
NE	Network Element
NEMO	Nominated Electricity Market Operator
NRA	National Regulatory Authority
OLD ER	Regulation (EC) No 714/2009 of the European Parliament and of the Council of 13 July 2009 on conditions for access to the network for cross-border exchanges in electricity and repealing Regulation (EC) No 1228/2003
OPP	Owner Pays Principle
OS	Operational Security
OSA	Operational Security Assessment
PATL	Permanent Admissible Transmission Loading

PCI	Project of Common Interest
PFC	Power Flow Colouring Method
PPP	Polluter Pays Principle
PSDF	Phase Shifter Distribution Factors
PSE	Polish TSO
PSP	Proportional Sharing Principle
PST	Phase Shifting Transformer Flow
PTDF	Power Function Distribution Factor
RA	Remedial Action
RAM	Remaining Available Margin
RAO	Remedial Action Optimisation
RCC	Regional Coordination Centre
RD	Re-Dispatching
RDCT	Re-Dispatching and Counter-Trading Methodology
RDCTCS	Re-Dispatching and Counter Trading Cost Sharing Methodology
RES	Renewable Energy Sources
ROSC	Regional Operational Security Coordination
RSC	Regional Security Coordinator
RTE	French TSO
SEE	South Eastern European region
SEPS	Slovak TSO
SO	Commission Regulation (EU) 2017/1485 of 2 August 2017 establishing a guideline on electricity transmission system operation
SOGCTF	System Operation and Grid Connection Task Force
SOR	System Operation Region
SSO	Secure System Operation
STD	Simple Tie-Line Decomposition
TATL	Temporary Admissible Transmission Loading
TERNA	Italian TSO
TEU	Treaty on the European Union
TFEU	Treaty on the Functioning of the European Union
TSO	Transmission System Operator
TTSF	TSO-TSO Settlement Function
UFE	Union Française d'Électricité
URSO	Slovak NRA
VÜEN	Austrian TSO
XBRNE	Cross-Border Relevant Network Element
XNE	Cross-Border Relevant Network Element
XNEC	Cross-Border Relevant Network Element with Contingency
XRA	Cross-Border Relevant Remedial Action